

Editors' Choice.
'Extra K' from Beagle Bros

October 1985
USA \$2.95
A CWC/I Publication

inCider

The Apple II Journal

RGB MONITORS:

Best of the
Brightest

How to Write
Great Game
Programs

Your First
Lesson in
Assembly from
Roger Wagner

Reviews of
Mouse Calc,
The Juki 6000,
and more

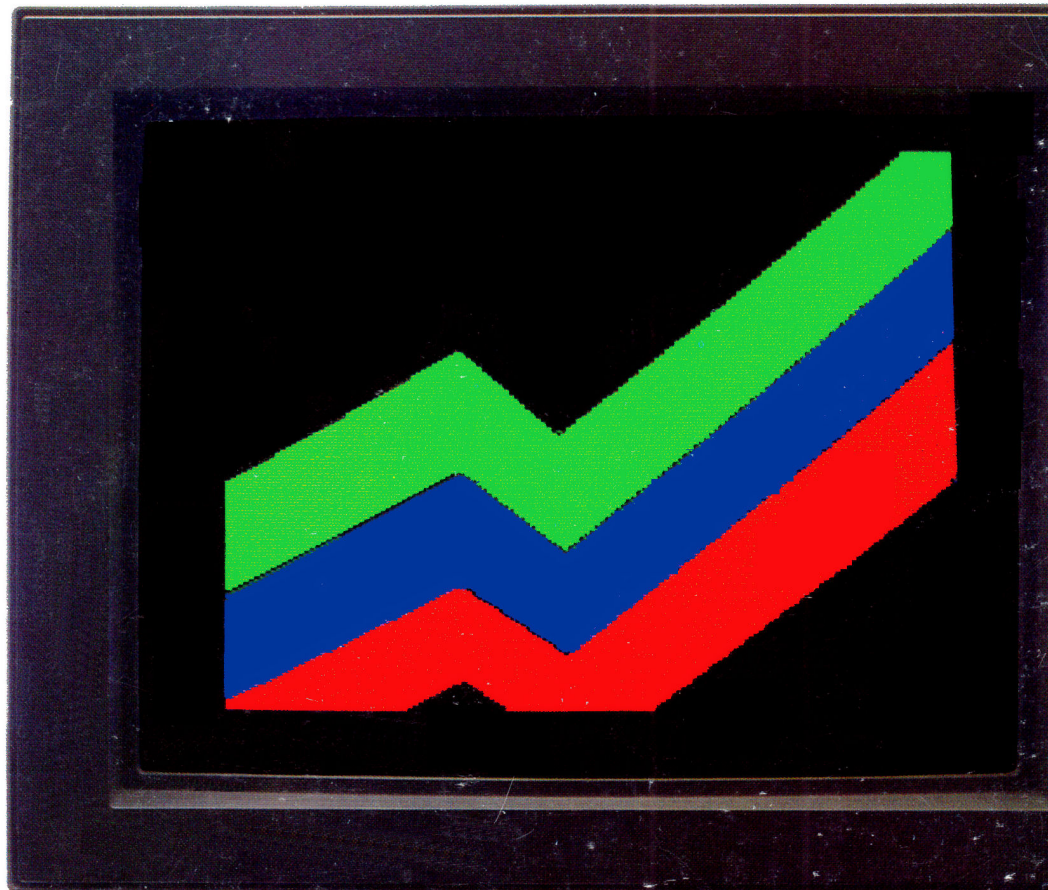

Superior firepower

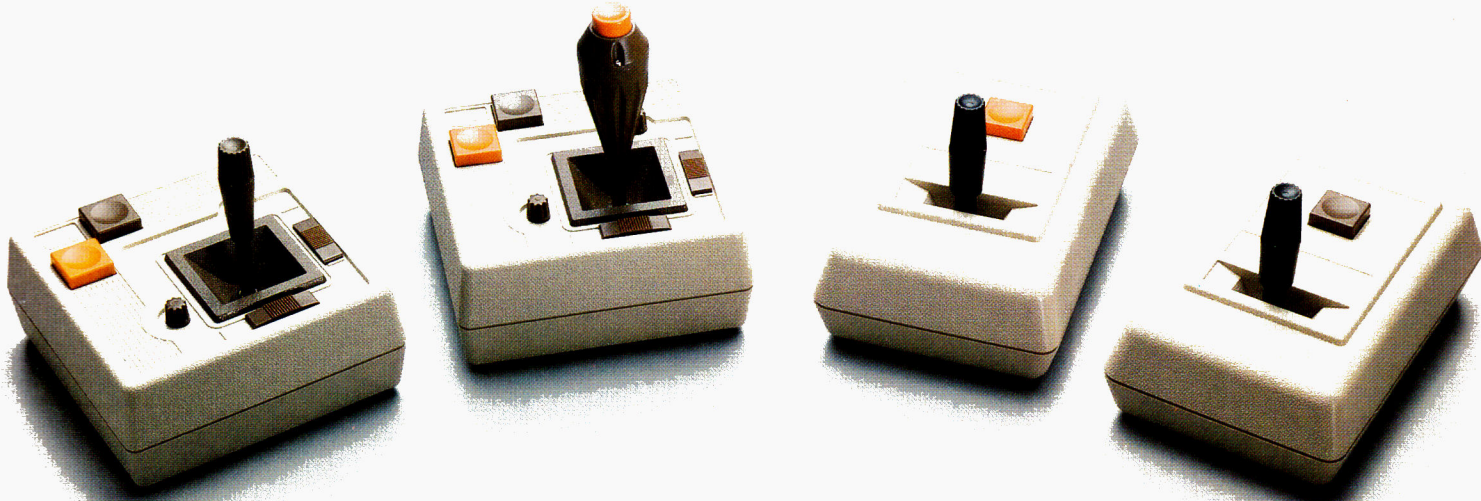

► MACH II™ and MACH III™ JOYSTICKS

The second generation MACH II and MACH III Joysticks incorporate a new slide-switch spring disconnect feature that requires no stick deflection and new rotary trims which are four times more precise.

Additional features include: "spring centering" or "positive true-positioning" modes of operation, electrical trims for each axis, two fire buttons on the deck of the control and a stainless steel ball as the main pivot for added precision and durability. Our MACH III Joystick has an added fire button on the stick handle.

These highly accurate and reliable 360-degree microcomputer cursor controls used for games, business and graphics applications provide more features, greater durability, and longer life cycles. Plug-in compatible with Apple II, IIE, IIC, IBM PC, PCjr and TRS-80 Color Computers.
MACH II \$44.95 / MACH III \$54.95

► PADDLESTICKS™

PADDLESTICKS are a new and unique paddle control design that promises to return the fun and excitement back to paddletype games. They are faster, easier to operate and less fatiguing than conventional-type paddles. The PADDLESTICKS operate as a single-axis joystick and are currently plug-in compatible with the Apple II, IIE and IIC personal computers.
\$44.95 (pair)

We manufacture a complete line of OEM Joysticks for industrial applications. Dealer and OEM inquiries invited. Apple II, IIE, IIC, IBM PC, PCjr and TRS-80 are registered trademarks of Apple Computer Inc., International Business Machines and Tandy Corp., respectively.



Formerly Hayes Products
1558 Osage Street
San Marcos, California 92069
(619) 744-8546

More bang for the buck.

Manufactured in U.S.A.

THE RIGHT CONNECTIONS

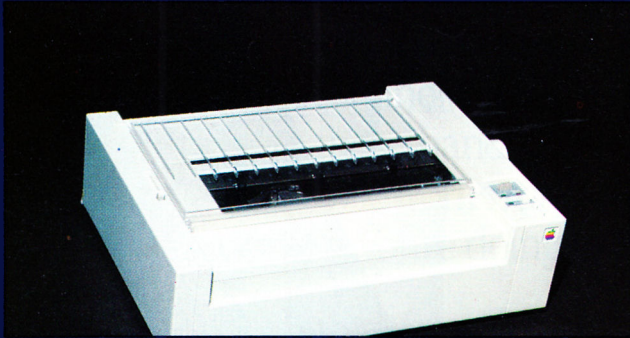

Printer serial port



Modem serial port



Clock/Calendar



Software Utilities

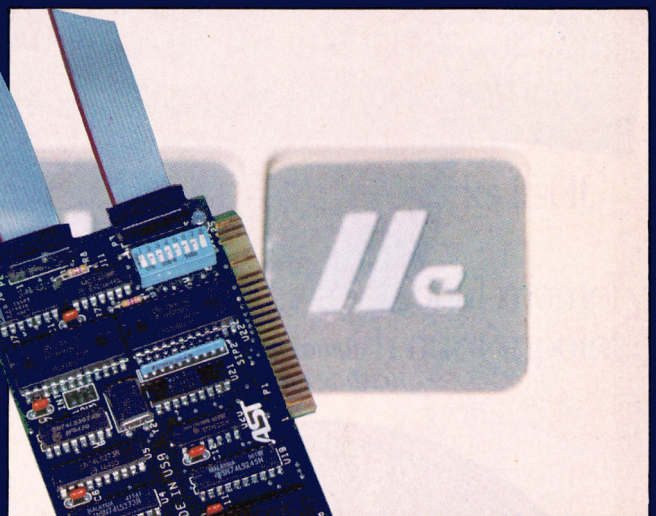

Apple IIe compatible

AST's Multi I/O™ is a multifunction card for the Apple IIe™ that does the work of three individual boards. First, the Multi I/O printer serial port gives you the right connection to hook up your ImageWriter™ or a compatible serial printer. Second, Multi I/O provides you with the right connection to communicate with the outside world via the modem/terminal port. And the versatile clock/calendar is the right connection for AppleWorks™ and ProDOS™ providing you with the accurate date and time even when your computer is turned off.

At AST we are consistently providing the right connections to help you get the most out of your personal computer. We set the standard for enhancement products for personal computers by bringing you the type of quality products you expect, but at a very cost effective price.

Apple, Apple IIe, ProDOS, Appleworks, ImageWriter, Lisa, and Macintosh XL are trademarks of Apple Computer, Inc. Multi I/O, RamStak, and MicroStar are trademarks of AST Research, Inc.

MicroStar™ is the 10 MB hard disk and tape backup (opt.) system that provides the right connection between the Apple IIe and dependable 3.5" Winchester Disk/Cartridge tape mass storage.



RamStak™ is the right connection for expanding the memory capability of your Macintosh XL™ (Lisa™). The card provides additional memory in configurations ranging from 512K to 2.0 MB.

We help Apples™ grow!™

AST
RESEARCH INC.

2121 Alton Avenue, Irvine, CA 92714
(714) 863-1333 Telex 753699 ASTR UR

AppleWorks



Only Pinpoint adds pictures to any AppleWorks document. So you can create party invitations that are truly exciting. Even if the weather isn't.



One glance and you can see your social schedule for months ahead. So it's a snap to slip this year's party in between the garlic festival and your breakdancing lessons.

Don't spend hours addressing envelopes and misspelling names. Pinpoint picks up names and addresses from invitations (or any documents) and drops them, letter perfect, onto envelopes. Even if you don't always spell those tongue-twisting names right, at least you'll be consistent.



Jot down important thoughts whenever they strike. The note pad is perfect for reminding you of things you can't do without. Or things you can.

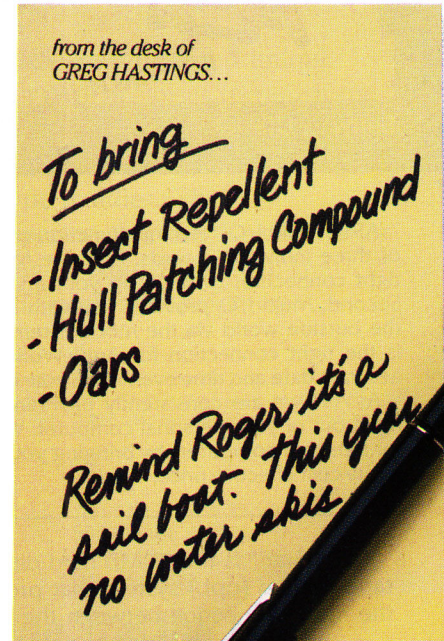

Impress a friend with a personal invitation. It's easy. The automatic dialer finds phone numbers displayed anywhere on the screen, not just in special files.

And it re-dials busy numbers automatically. So you're next in line as soon as your friend's broker hangs up.

Accessories. \$69.

Nine accessories to be precise. And in no time, they'll be so much a part of your AppleWorks routine, you'll think of them as built-in, not added-on. Why? For openers, these handy desktop timesavers "pop-up" via windows from inside AppleWorks (*and most other ProDOS programs*). So you can stop what you're doing to jot down a note, address a letter, or call a friend.

You can even figure out some figures with our calculator. Tap data bases or other computers through our communications window. Even whip out short memos, forms and labels with our line-at-a-time typewriter. And then continue AppleWorks without missing a beat. Or a byte.

What's more, Pinpoint's as easy to use as AppleWorks itself. Same commands. Same hardware.

Plus you can boost Pinpoint's performance by adding additional memory, a hard disk, a modem, or one of many popular printers. And, with our Pinpoint Toolkit, you can even add desktop accessories of your own.

Want more?

Then visit your local computer shop.

Or call (415) 530-1726 for a dealer

near you. (*Dealers. Please call First Software (800) 343-1290 or Softsel (800) 645-7778.*)

You'll see that Pinpoint does more than give AppleWorks a handful of accessories.

It gives AppleWorks the works.

A hand is shown pointing to the Pinpoint logo on a document. The document also contains text describing the accessories.

Add the convenience of an appointment calendar, a telecommunications window, graphic and text merging, and six other desktop accessories to your AppleWorks program.

Pinpoint

ARTICLES

16 Screen Tests

by Bill O'Brien

Observe from the director's chair as our critic reviews the performance of seven leading RGB monitors.

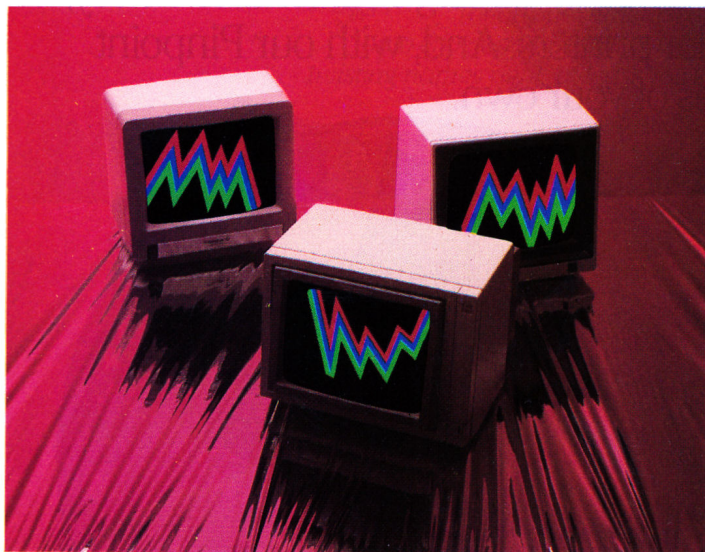

24 Getting into Shapes

by Bob Ryan

Put your arcade games on a strict regimen of basic vector-shape animation—you'll see immediate results through painless graphics programming. Program listings begin on page 104.

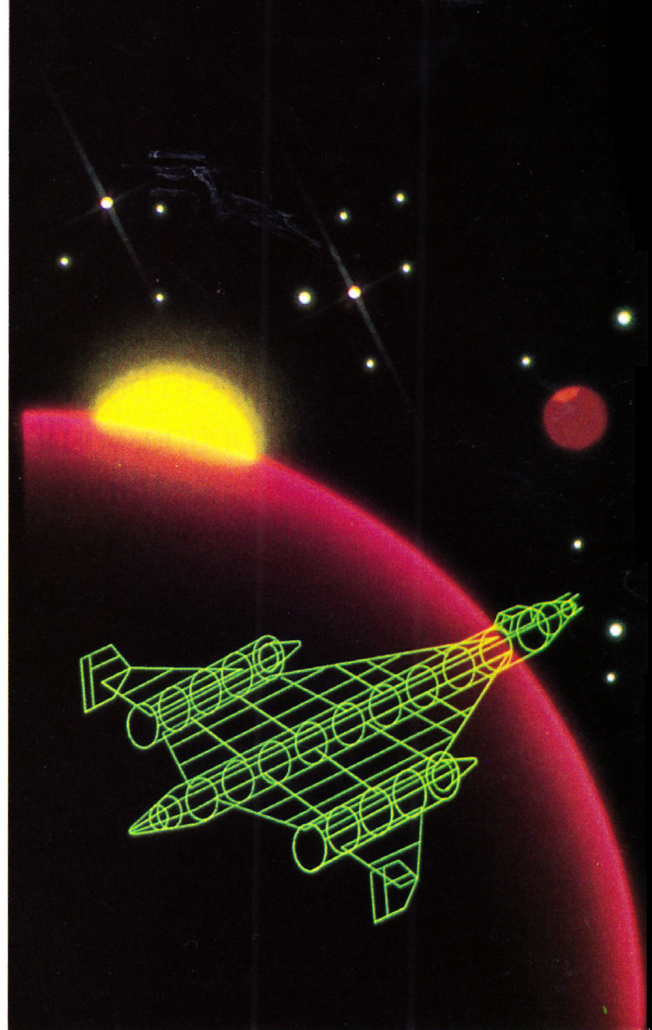

34 Master of the Game

by R.A. Dousette

Teach your Apple a few tricks. This Pascal tic-tac-toe program helps your micro improve its strategy as the match goes on. The program listing begins on page 106.

42 The Spirit of Adventure

by James L. Muller

Are you bored with run-of-the-mill adventure games? We tip you off to a few programming secrets you can use to customize your own games. Program listings are on page 110.



DEPARTMENTS

Editorial	6
Letters	8
Corrections	13
News Line	14
<i>In the Pilot's Seat; Computer Crime; VDT Controversy</i>	
Pascal Primer	52
<i>Pascal's Turtle</i> by Tom Swan	
Apple Clinic	60
<i>Overseas Voltage; RGB Interfaces; Plotting Graphs with VisiTrend/Plot</i> by Jim Sather	
Right of Assembly	68
<i>Beneath Applesoft: The First Step</i> by Roger Wagner	
BackTalk	81
<i>This month's survey: inCider's new look</i>	
Reviews	82
<i>Juki Model 6000; Prolmage; Mouse Calc; The Cari Portable Powered Work Station; MW-100 C-Print Interface</i>	
New Products	94
Beginner's Page	102
<i>Step-by-step instructions on how to type in inCider's program listings</i>	
Game Room	113
<i>Questprobe Featuring The Hulk; Ring Quest; Calculated Risk!; Swiss Family Robinson</i> by Brian J. Murphy	
Hints/Techniques	116
<i>Ditto; Pseudorandom Numbers</i>	

Ask inCider	120
<i>Reading the ProDOS Directory; Using FORTRAN; Calling Mouse Characters</i>	
DataGram	124
by Matthew Lesko	

Reader Services	125
Coming Attractions	126
Editors' Choice	128
<i>Extra K</i>	

Cover photo by Ed Judice

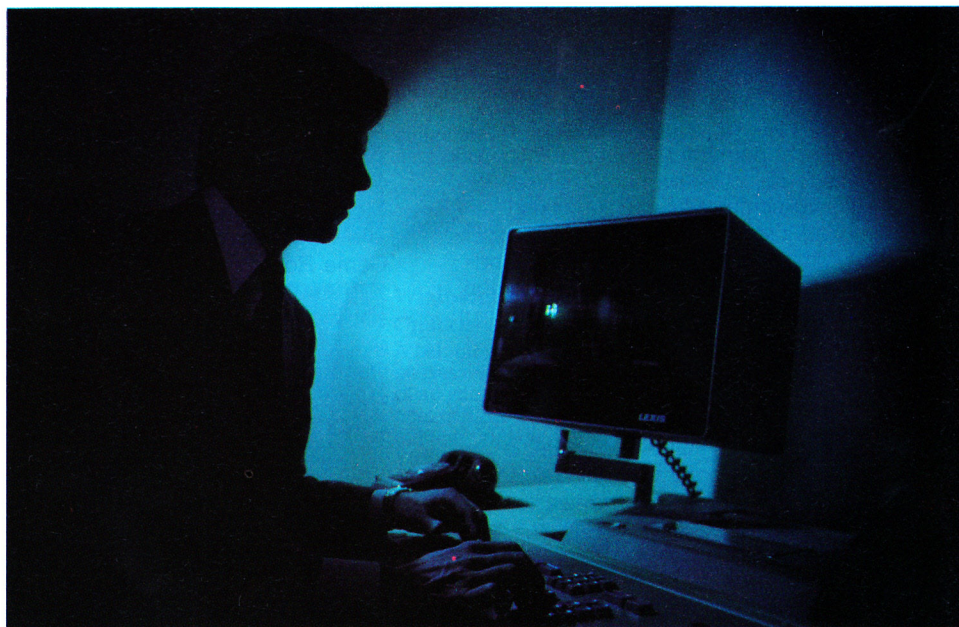

inCider (ISSN #0740-0101) is published monthly by CW Communications/Peterborough, Inc., 80 Pine Street, Peterborough, NH 03458. Phone: (603) 924-9471. Second-class postage paid at Peterborough, NH, and additional mailing offices. (Canadian second class mail registration number 9590.) Subscription rates in U.S. are \$24.97 for one year, \$38.00 for two years and \$53.00 for three years. In Canada and Mexico, \$27.97—one year only, U.S. funds drawn on a U.S. bank. Nationally distributed by International Circulation Distributors. Foreign subscriptions (surface mail), \$44.97—one year only, U.S. funds drawn on a U.S. bank. Foreign subscriptions (air mail), please inquire. All U.S. and Canadian subscription

correspondence should be addressed to *inCider*, Subscription Department, P.O. Box 911, Farmingdale, NY 11737. Please include your address label with any correspondence. For questions concerning your subscription and to place subscription orders, please call us toll free at 1-800-645-9559 between 9 a.m. and 5 p.m. or write to *inCider*, Subscription Department, P.O. Box 911, Farmingdale, NY 11737. Postmaster: Send address changes to *inCider*, Subscription Services, P.O. Box 911, Farmingdale, NY 11737. (Send Canadian changes of address to: *inCider*, P.O. Box 1051, Fort Erie, Ontario L2A 5N8.) Entire contents copyright 1985 by CW Communications/Peterborough, Inc.



Old Wine in New Bottles

by Susan Gubernat

Yes, we're reversing the cliché—new wine in old bottles—to assure you that what you're holding is indeed your October *inCider*, full of the practical computing information and timely, objective product analyses you've come to expect from us.

Yet, it's a redesigned *inCider*.

With the mixture of trepidation and pride one feels after an image-altering haircut (or beard-shearing, so I'm told), we present our new persona.

From our point of view, the redesign is a culmination and a literally graphic embodiment of some of the changes and reaffirmations we've made in response to your criticisms and suggestions over the last few months.

To effect this, we've had veteran freelancers—like Bill O'Brien—arise phoenix-like from the ashes of their old columns. Now they'll preen in the spotlight of in-depth feature reviews of products you're considering adding to your repertoire—last month, hard-disk drives; this month, RGB monitors.

Meanwhile, we'll continue to give you the information you need to develop programming expertise, including ready-to-type-in programs in columns and feature articles, like this

month's series on game design, in a new format we hope you'll find even more readable and easy to use.

You'll also notice that we've kept what's vintage at *inCider*, but changed some labels: For example, Cider Press has become News Line; The Game Reserve now appears as Game Room.

In an ongoing commitment to tutorials, we added Pascal Primer in August, as you'll recall, and debuting this month, in response to your requests, Right of Assembly (page 68), a new tutorial by that Merlin of assemblers, Roger Wagner.

Before going any further, I'll direct you to this month's BackTalk BBS poll (page 81). Please take the time to let us know what you think about our new look as it strikes you right from the start. Register your votes immediately via modem when you call (603) 924-9801. And thanks.

MacContest

It's time to take note of some of the least memorable moments in microcomputer publishing history. This month I'll draw your attention to the sterling prose of my eminent colleague at *MacWorld*, David Bunnell. In his August editorial, he remarks,

"Let's be honest; the Apple II is a dog."

Have you ever noticed how often Macfanatics find it necessary to dump on the II? It seems a defensive, quibbling posture, unworthy of us all.

We could ignore such tactics, of course—or raise the ante. Surely those of us in the Apple II world can do better when it comes to describing the Mac.

So I'll tear a page from John Dvorak's *InfoWorld* columns featuring new meanings for the acronym IBM as supplied by his readers (as in Imperialism by Marketing and Irresponsibly Behaved Multinational), and ask you to help me come up with three-word (as opposed to four-letter) descriptions of the other Apple. (Of course, "Mac" didn't start its life as an acronym, but we won't hold that against it.)

To get you started: How about Most Architectonically Cute, Mainly Advertising Clout, Mutually Assured Commercialism, and Market-Adaptable Computer? Send your suggestions to me, and I'll publish some of the best ones here.

And thanks to Bunnell and Dvorak for kicking this off in my head: proof that computer journalists are good for something. ■

Big Game Hunting? Try Baggin' Our Dragon.

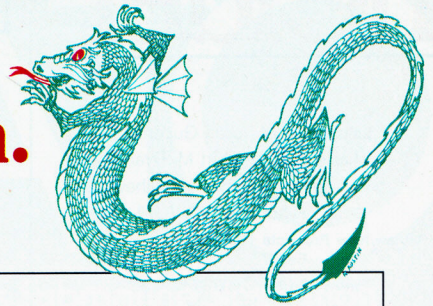

It's the biggest game in town

Our dragon, of course, is Wizardry—that unique series of computer recreation programs designed for Apple users who are seeking the ultimate “big game” challenge.

Since its debut, Wizardry has been the best-selling computer game of its kind.

For a very good reason:

Because Wizardry is more than just a game, more than a diabolically clever maze.

Wizardry is a complex world of variety and depth. A world of richness and pleasure.

Packed with suspense, full of surprises, Wizardry is enchanting—a compelling

diversion that turns your leisure time into prime time.

Wizardry is powerful and sophisticated. A simple command system, 3D maze displays and superb programming provide you with month after month of involvement and satisfaction.

Four years old and still growing, the game is already recognized by critics and game lovers as a classic.

Simply stated, Wizardry is the finest fantasy role-playing computer game you can buy.

Set your sights on the best. Track down Wizardry—the biggest game in town.

Enter the World of Wizardry®

A Classic Encounter

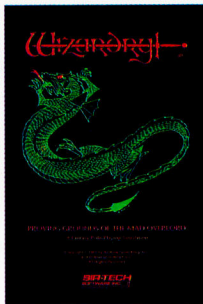

Proving Grounds of the Mad Overlord

The First Scenario

Unlike any other game you have ever played. A fascinating 10-level maze full of monsters, sorcery, traps and treasures. As you gain skills, the characters you create grow stronger, richer, wiser and better able to survive. The final goal is elusive. Your experience... unforgettable.

Twice voted “All Time Most Popular Computer Program” —Softalk Readers

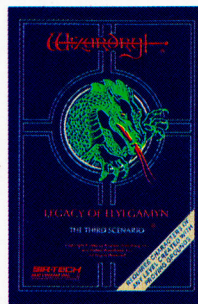

Legacy of Llylgamyn

The Third Scenario

A spellbinder that advances the classic traditions of Wizardry. Find the great dragon L'kbreth and save the people of Llylgamyn. Includes full screen maze display and Windo-Wizardry, the revolutionary pop-up window graphics system. Requires brave adventurers of any level developed in PROVING GROUNDS.

“... A Landmark in Graphics Advancement” and “The Best Yet” —Softalk

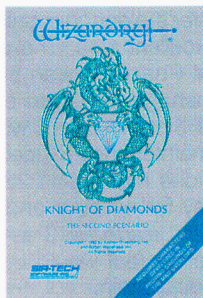

Knight of Diamonds

The Second Scenario

This classic journey should only be attempted with those Wizardry heroes who have attained the 13th level of ability in PROVING GROUNDS. Their challenge—and yours—to adventure through a six-level maze and become the Knight of Diamonds. First-rate fantasy!

Awarded “Best Adventure Game for the Home Computer” —Game Mfrs. Association of America

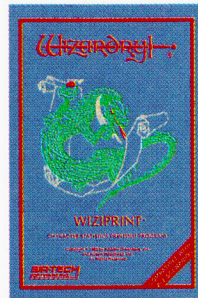

Wiziprint

Character Statistics Printout

A helpful utility program that prints the possessions, attributes and known spells of all your Wizardry characters. Quick, neat and easy-to-read. For use with 80-column printers. Compatible with all Wizardry scenarios. A real timesaver!

“Wiziprint is a very handy utility disk for ardent Wizardry players” —Roe R. Adams III, Softalk

LOOK FOR THE DRAGON—
SYMBOL OF WIZARDRY.
PROMISE OF EXCELLENCE.

All software available for Apple II series computer 48k
Coming soon for the Macintosh
Proving Grounds also available for IBM PC and PCjr 64k

SIR-TECH
SOFTWARE INC.

6 MAIN STREET • OGDENSBURG, N.Y. 13369 • (315) 393-6633 **LEADERS IN COMPUTER FANTASY ROLE-PLAYING**

Editor in Chief Susan Gubernat
Technical Editor Robert M. Ryan
Managing Editor Dawn F. Matthews
Senior Editor Eileen T. Terrill
Review/New Products Editor Paul Staff
News Editor Cynthia K. Carr
Copy Editor Robin Florence
Assistant Editor Lafe Low
Proofreader Peter Bjornsen
West Coast Editor Wendy Lea McKibbin
 (415) 328-3470

Advertising

Sales Manager/Northeast Paul Boulé
Sales Representative (800) 441-4403
 (603) 924-7138
Southeast and Central Rich Alden
Sales Representative (800) 441-4403
Northwest Sales Donna Pomponi
Representative 1060 Marsh Road
 Menlo Park, CA 94025
 (415) 328-3470
Southwest Sales Charles Durham
Representative 2082 S.E. Bristol Street
 Santa Ana, CA 92707
 (714) 756-1984
Advertising Coordinator Kim Labbe
 (800) 441-4403
Marketing Services Michael Duran
Manager

Design

Art Director Donna Wohlfarth
Production Supervisor Phyllis Pittet
Production Assistant Cindy Boucher
Ad/Graphics Production Fiona Davies

Graphic Services

Graphic Services Dennis Christensen
Manager
Manufacturing Manager Susan Gross
Film Preparation Robert M. Villeneuve
Supervisor
Typesetting Supervisor Linda P. Canale

CW Communications/Peterborough

Chairman James S. Povec
President Debra Wetherbee
Vice President/Finance Roger Murphy
Assistant General Matt Smith
Manager
Assistant to VP/Finance Dominique Smith
V.P. of Planning and William P. Howard
Circulation
Circulation Manager Frank S. Smith
Direct & Newsstand Raino Wirein
Sales Manager (800) 343-0728
Director of Credit, Sales, William M. Boyer
and Collection
Executive Creative Christine Destrempe
Director
Founder Wayne Green

inCider's BBS (bulletin-board system)
 On line 24 hours
 (603) 924-9801

Razzle Dazzle

I am a subscriber and an avid *inCider* reader, and have been since I got my Apple IIe. I look forward to your software and hardware reviews the most, and I respect your reviewers' opinions. Regarding the review of Dazzle Draw, however, in the June 1985 issue, I have an important update.

Dazzle Draw is not fully compatible with the Apple Extended 80-column Color Card. (I have this card hooked up to the Model 100 RGB monitor.) Broderbund Software says, "We are working on a version that should support the RGB card and monitor, [but] we cannot guarantee the exact date or [that] the problem will be corrected totally." The problems encountered are fairly substantial:

- 1) The initial menu screen (any text screen) doesn't appear. A series of apparently random lo-res graphics takes its place.
- 2) Text on the drawing screen is illegible. You simply can't read it without considerable eyestrain.
- 3) Solid painting and drawing doesn't yield solid colors. Traces of other colors often appear along the perimeter of your drawing.

In all other respects, I agree with Cynthia Field's review. The program is really good. In fact, the program is so good that I have decided to keep it, despite its problems. I just wanted to let other readers know about these difficulties, so that they can decide for themselves.

Robert Jackson
 923 South Alfred Street
 Alexandria, VA 22314

Rotten Apples?

As a concerned computer hobbyist. I am writing to you about a company called TG Products. More than a year ago, I purchased one of its joysticks for my Apple II Plus, because of comments others have

made about the high quality of this peripheral. About six months later, it broke. I returned it to TG Products in Plano, Texas, for repair. It wasn't under warranty, so I offered to pay for fixing it. Since then, despite three letters, I have not heard from the company, nor have I gotten my joystick back, repaired or otherwise. My letters have not been returned, so the address must be good.

As a leading publisher in the computer field, you must have as much interest in removing the rotten apples from the business as its customers do.

Ralph J. Hamilton
 18057 East Berry Avenue
 Aurora, CO 80015

T.G. Products (formerly Personal Peripherals) has changed its address. Contact the company at 2201 South Mobberly Street, Longview, TX 75607, (214) 758-8874. T.G. Products customers should send damaged joysticks and a check or money order for \$7.50 to the attention of Linda Toler. —eds.

Busy BBS's

I think *inCider's* electronic bulletin board is an excellent idea. The only problem is that I haven't been able to call it. (I did manage to get on once, only to be told that the board would be down for maintenance.) I tried calling the board one night at 11:23 p.m., and it was busy for an hour and ten minutes. I set my alarm for 3 a.m., in hope that no other fool would be calling then—no luck again.

I'm sure you have a popular board, but what are the chances of putting a time limit on calls? Most of the boards to which I belong limit members to 20 minutes. It's not fair to have someone sign on and tie up the board for hours at a time, downloading everything in sight. Twenty minutes is plenty of time to download a program or two, leave some mail, and check out messages. (You may already have such a policy—

I haven't been able to find out.) Perhaps adding a second line could alleviate the problem.

At any rate, keep the magazine coming—you're doing an excellent job.

Raymond P. Stickler
3 West Oak Street
New Baden, IL 62265

We've been pleased with the favorable response to our BBS. We are considering a 30- or 40-minute time limit for callers, and we're investigating adding a second line. —eds.

Resetting and Rebooting Advice

I found the "Reset and Reboot" letter in the April 1985 issue of *inCider* misleading. I'm afraid many of your readers may take its advice, then find themselves wondering if their computers are malfunctioning.

In his article "Capturing Big Game Screens" (*inCider*, November 1984, p. 62), Kerry Lanz very clearly explained that without purchasing additional hardware specifically designed to dump screens, you can dump only about 50 percent of them. You cannot capture a screen by pressing control/open-apple/reset. That's like switching your Apple off and on—using this method to boot a disk disturbs the memory locations of the hi-res image. You will capture the image you wanted, but invariably, it will have lines through it. The amount of distortion depends on how long you hold down the open-apple key.

It's important for your readers to pay attention to this technical point, so that if they do use this method to boot screen-saver programs, and they do experience distortion of captured screens, they'll know that their Apples don't need to visit the nearest repair dealer.

Janet M. Calvert
47 Oakland Avenue
Bloomfield, NJ 07003

Continued on p. 13.

GATO™

WW II GATO-Class Submarine Simulation

Spectrum HoloByte Inc.

Macintosh 128K Now Available

Now YOU step in!

IBM PC Series (Inc.PCjr)
128K RAM
One Double-Sided Disk Drive
COLOR Graphics Adapter
Graphics Monitor
(RGB recommended)

Apple IIe and IIc
128K RAM
One Single-Sided Disk Drive
Joystick Optional
(64K, 80 Column Cards available for \$179.95)

SPECTRUM HOLOBYTE, INC., 1050 Walnut, Suite 325, Boulder, CO 80302 (303) 443-0191. Check your local computer store or wherever software products are sold. Dealer Inquiries call: (800) 621-8385 x 262. Written by Paul Arlton and Ed Dawson. IBM and Apple are registered trademarks of International Business Machines Corp. and Apple Computer, Inc. respectively.

ANNOUNCING THE FAMILY SOFTWARE SPECTACULAR.™

BUY 3, GET 1 FREE.

CHOOSE FROM OVER 50 LEADING TITLES.

What do you call an offer that brings together, for the first time ever, five leading brands of home software?

The Family Software Spectacular!

And it's your opportunity to choose a *free* software program from the best titles on the market today. All you have to do is buy any combination of three titles from any participating brands during this special offer period. And we'll send you another one of your choice—*free!*

It's a one-of-a-kind value your family shouldn't miss.

FISHER-PRICE® A NAME YOU CAN TRUST.

For years Fisher-Price has been known for helping children develop skills as they play. With Fisher-Price™ Learning Software, your child can develop skills in five key areas: math, language, creativity, basic learning and computer literacy.

Your child will love developing and testing language skills with the help of PETER RABBIT READING, a program that uses voice to teach sound and letter recognition in words.

WINDHAM CLASSICS.™ CLASSIC NOVELS COME TO LIFE.

Pick up Windham Classics, graphic interactive fiction based on some of the greatest adventures of all time.

They're great for kids, yet fun for all ages.

Enjoy "THE WIZARD OF OZ.™" You are Dorothy, and each of your decisions determines your adventure. There's more than one adventure to be had as you meet old friends and new in the land of Oz.

WORK BETTER WITH BETTER WORKING.™

Constantly erasing and retyping? Unsure of your spelling? WORD PROCESSOR WITH SPELLCHECKER is exactly what you need. This full featured word processor includes the 50,000 word AMERICAN HERITAGE DICTIONARY™ spellchecker which detects over 99% of misspelled words.

The full line also includes FILE & REPORT and SPREADSHEET—titles that represent the best values on the market today.



**SPINNAKER® THE LEADER IN
FAMILY LEARNING SOFTWARE.**

From pre-school counting to high-school compositions, Spinnaker offers the high quality educational programs you have come to expect. For example, there's the HOMEWORK HELPER™ series which provides step-by-step methods for improving writing and math skills and helps kids tackle otherwise troublesome school assignments.

**TELARIUM.™
INTERACTIVE FICTION AT ITS BEST.**

Here's graphic interactive fiction by famous writers of science fiction, fantasy, and mystery like Ray Bradbury, Arthur

C. Clarke and Erle Stanley Gardner. Each story unfolds with you in the center of the action – and completely in control. In PERRY MASON: THE CASE OF THE MANDARIN MURDER,™ you are the world famous criminal lawyer. Challenge the evidence. Cross-examine the witness. Only you can prove your client's innocence. And time is running out.

A SOFTWARE OFFER FOR ALL AGES.

Any software offer including something for everyone in the family is certainly fantastic. But combine that with a free product offer and what you have is something spectacular. Look for the specially marked boxes of The Family Software Spectacular at your retailer.

The Family Software Spectacular™



**TURN PAGE FOR MORE INFORMATION ON THE FAMILY
SOFTWARE SPECTACULAR. →**

© 1985 SSC., One Kendall Square, Cambridge, MA 02139. All rights reserved. Titles available on most popular home computers. Spelling Software developed by Houghton Mifflin Company, publishers of the *American Heritage Dictionary*.
THE FAMILY SOFTWARE SPECTACULAR is a trademark of Spinnaker Software Corp. SPINNAKER is a registered trademark of Spinnaker Software Corp. FISHER-PRICE is a trademark of The Quaker Oats Company and is used under license. WINDHAM CLASSICS is a trademark of Windham Classics Corp. TELARIUM is a trademark of Telarium Corp. BETTER WORKING is a trademark of Spinnaker Software Corp.

What every Apple II+ and IIe user should ask before buying the "Sider" 10 MB hard disk:

When a company offers a superior quality 10 megabyte Winchester hard disk for only \$695, it's bound to raise a few eyebrows... and a lot of questions. The fact is, you're probably already wondering "Can I really get a 10 megabyte hard disk that's *reliable* for only \$695?" The answer is: ABSOLUTELY...when you choose the Sider from First Class Peripherals.

What's so great about the Sider?

For starters, the Sider lets you boot your *Apple II+* or *IIe* directly off the hard disk—unlike some other Winchester subsystems. Rebooting is also trouble-free. And the disk is partitionable, allowing you to allocate space to four operating systems on the same disk. The Sider supports: Apple DOS 3.3; Pro DOS™; Apple Pascal; and CP/M®

What's more, a small "footprint" lets you incorporate the compact Sider into your existing computer set-up with ease.

In addition, with the Sider, you not only pay far less for the subsystem, you also save money on installation. Because, unlike other 10 MB systems that require the purchase of expensive "extras," the Sider is *plug and play*. Everything you need is provided, including cables, host adaptor, installation software and manual.

What makes it so reliable?

To start, the Sider is manufactured, and sold exclusively, by First Class Peripherals, an innovative computer company which is backed by Xebec. The computer industry's leading manufacturer of disk controllers, Xebec has over a decade of experience serving customers like IBM, Toshiba, Texas Instruments and Hewlett Packard. It's this kind of expertise that helps assure the Sider's performance.

Special design features further enhance reliability. The Sider's controller is the field-proven, industry standard Xebec SI410A. And Xebec's 3200 drive tester, the

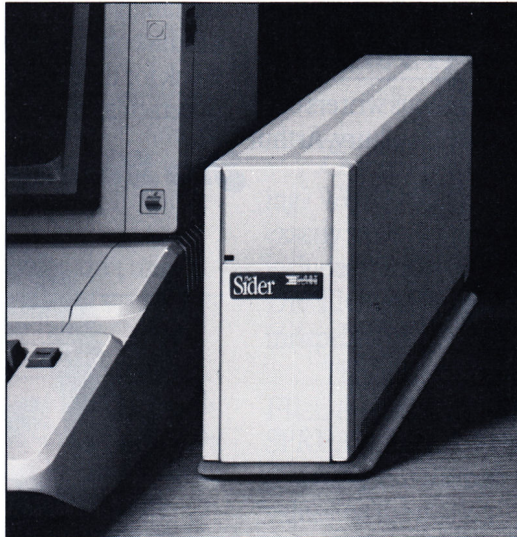

"Only \$695?"

toughest in the industry, ensures that the Sider will operate reliably. One more assurance of the \$695 Sider's quality: it's UL Approved and FCC Class B rated.

But why is it only \$695?

You pay less for the Sider than for other 10 MB hard disks simply because you're paying for the superior quality components inside the unit, not for a lot of retail overhead costs. Since First Class Peripherals sells direct, you avoid dealer and dis-

tribution expenses, and pay only for the product.

What about a guarantee?

Like many experienced Apple users, you may be reluctant to buy a hard disk priced at only \$695 without first asking for yourself how it performs. That's why First Class Peripherals offers you a reassuring, money-back guarantee that eliminates any risk on your part. Simply order the Sider and use it for 15 days. Then, if you're not entirely satisfied, return it and receive a full refund—no questions asked.

The Sider also comes with a full one-year limited warranty. Plus, there's a convenient, toll-free hotline you can call anytime you have a technical or service question, or need help.

Don't delay. Order the Sider now.

To receive the Sider 10 megabyte Winchester hard disk subsystem for only \$695, simply order using the coupon below. For faster service, order by phone and charge to your VISA, MasterCard or American Express. (You can also call us if you have any questions or technical concerns about the Sider. We'll see you get the help you need.) Call toll-free:

1-800-538-1307

In Canada, call 1-800-227-7792
Extension 242

Yes, please send me the Sider, including half-height 10 megabyte Winchester hard disk drive, Apple adaptor board, cable, complete installation software and documentation.

I prefer to pay as follows:

- I've enclosed my check or money order for \$695* + \$15 shipping and handling, payable to First Class Peripherals.
- Please bill the following credit card account for \$695* + \$15 shipping and handling:
 VISA MasterCard American Express

Card # _____ Exp. Date _____

Signature _____
*Residents of CA, NV and PA, please add appropriate sales tax.

Name _____

Address _____

City _____

State _____ Zip _____

Telephone (area code) _____

Mail to:

FIRST CLASS PERIPHERALS

3579 Highway 50 East
Carson City, NV 89701
242

Continued from p. 9.

Save Your \$ense

In your April issue (p. 85), there was a review of Dollars and \$ense by Paul DiBara. The review was little more than a synopsis of the sales hype on the back of the box. Recently, I bought this program and ran into some major difficulties with the checkbook-balancing portion of the program.

After several days of pulling out my hair and looking for my errors in data entry or program use, I called the discount-software store where I purchased the program. The salesman who had previously claimed to have used the program, and had recommended it highly, now admitted it had been some time since he had had any "hands-on" experience with it. He suggested I call the manufacturer in California, naturally at my expense.

Monogram's technical support was very helpful. The representative said the company had had "a little trouble" with older versions of the program, which would not balance properly. He agreed to replace the disks upon their return.

The reviewer should have explained a weakness in the documentation: you can't alter highlighted budgets. The manual points that out, but gives the impression that this restriction is etched in stone. To alter a budgeted item that has been highlighted, you must go back and remove all entered transactions in that particular account. The program only highlights accounts when you've made all transactions. The book doesn't explain how they become highlighted or how to alter them once they are. In fact, the manual states that you can't alter them at all once they are highlighted.

My point is that Paul DiBara's review lacked practical information about the program—such as a description of the problems users have run into. A good reviewer should use the program and check with representatives of the manufacturer on the problems they have experienced to date. Apple user groups are also excellent sources of this information.

A. Frank Ross
14216 Village View Drive
Tampa, FL 33624

In the Dollars and \$ense review heading in your April issue, the following statement appears: "Financial man-

agement, Apple IIc, or IIe with 128K." I recently purchased Dollars and \$ense, and I'm having a great deal of difficulty getting started with it. My Apple IIe has only 64K. Do I need 128K in order to run this program?

Wilson Cranford
Candy Lane
Cummaquid, MA 02637

Yes, you do. The programming in Dollars and \$ense requires 128K of RAM; the package cannot run on a machine with only 64K. —eds.

I give Paul DiBara's review of Dollars and \$ense just two stars. How far did he take it through its paces? I purchased Dollars and \$ense for our IBMs at work to encourage my staff to use them. It was such a success, I purchased it for my home computer, an Apple IIe. What a flop.

The graphs (a big feature of the product) will not print with an Image-writer without going through horrible gyrations. I could understand it if I were using hybrid products, but there is no excuse for it not working on an "all-Apple system."

Let's hope that Monogram improves its products for Apple II's. It will be interesting to see if Monogram takes the initiative to move ahead when so many software developers have not.

James S. Linville
10432 Melissa Hill Road
Richmond, VA 23236

inCider welcomes readers' comments regarding articles, letters, or other topics of interest. We reserve the right to edit letters for clarity, style, and space. Please address your correspondence to Letters, inCider, 80 Pine Street, Peterborough, NH 03458.

Corrections

In "Hard-Driving Disks" in the September 1985 *inCider*, the key was inadvertently omitted from the hard-disk comparison chart (pp. 26-27). Areas shaded in salmon denote which features apply to the particular disk systems named at the left of the table.

The price of Dave Winfield's Batter Up! was listed incorrectly in August's New Software (p. 80). The game is available from Avant-Garde for \$39.95.

[SEE PREVIOUS PAGE]

HERE'S HOW YOUR FAMILY CAN PARTICIPATE IN

The Family Software Spectacular™

REMEMBER, TO RECEIVE A FREE PRODUCT YOU MUST PURCHASE ANY THREE TITLES FROM THE PARTICIPATING BRANDS (IN ANY COMBINATION) AND MAIL YOUR ENTRY NO LATER THAN JANUARY 31, 1987.

1. Start by saving the receipt(s) from your software program purchases. (It is not necessary for software purchases to appear on one receipt. Photocopies of the receipt(s) are accepted. Receipts must be dated BETWEEN JULY 1, 1985, AND JANUARY 31, 1987.)
2. Cut the proof-of-purchase tab from each of the three user manuals that come with the programs. (Photocopies not accepted.)
3. Attach the purchase receipt(s) and the three original proof-of-purchase tabs to one separate sheet of paper.
4. Fill in the form below and place the completed form in an envelope with:
 - a. A sheet of paper with three original proof-of-purchase tabs and your purchase receipt(s)
 - b. A check or money order for \$3.50 to cover postage and handling. (Canada residents please send \$5.00 for postage and handling.)

Make check payable to THE FAMILY SOFTWARE SPECTACULAR and mail envelope to:

THE FAMILY SOFTWARE SPECTACULAR
P.O. Box 1327, Cambridge, MA 02238

ORDER FORM

To receive your free program, this form must be filled out completely. Please print.

Free Product Chosen:

Title/Brand _____

Computer/Model _____

MAKE SURE THE PRODUCT YOU CHOOSE IS AVAILABLE ON THE COMPUTER SYSTEM YOU HAVE SELECTED.

Name _____

Phone (____) _____

Address _____

City _____ State _____ Zip _____

TITLES PURCHASED

1. _____

2. _____

3. _____

BRANDS

DATE OF PURCHASE

1. _____ 1. _____

2. _____ 2. _____

3. _____ 3. _____

Allow 6-8 weeks for delivery of your free software program. Note: All receipts and envelope postmark must be dated prior to January 31, 1987. Offer good in the US and Canada only. Void where taxed, restricted or prohibited by law.

NEWS LINE

by Cynthia K. Carr, *inCider* staff

The Sky's the Limit

If you always wanted to fly your own plane, MicroProse is ready to make your dream come true. Along with Cessna Aircraft Company, the simulation-software firm is sponsoring a "Learn to Fly" contest—in which you can earn your pilot's wings.

"We thought it was time to offer [people] as close to the real thing of flying as we can get," says Paula Myers, public-relations manager for MicroProse.

With the discovery-flight coupon (available with MicroProse packages) and \$20, you can sit in the pilot's seat with an instructor and fly around the air strip. You can then sign up for your pilot's license and the MicroProse drawing.

The grand-prize winner will receive the chance to qualify through a certificate and license to pilot his or

her own aircraft. Second prize, a solo package, will be awarded to three winners. For third prizes, MicroProse and Cessna will give away 20 introductory flights if winners present a discovery-flight coupon.

The contest, which runs from September 1985 until January 1986, is also open to MicroProse dealers and distributors. Winners will be announced in February 1986. For details, contact MicroProse Software at 120 Lakefront Drive, Hunt Valley, MD 21030, (301) 667-1151.

VDTs and Baby, Too

Headaches, eyestrain, and even psychological problems have been blamed on video-display terminal use (see *The Cider* Press, April 1985, p. 13). But researchers at Mount Sinai Hospital's medical

school plan to conduct a four-year study to determine the effects of VDTs on 10,000 pregnant workers.

According to *The Wall Street Journal*, researchers intend to see if the low levels of nonionizing radiation from VDTs are associated with miscarriages and birth defects. Currently, many scientists say the radiation levels are too low to harm biological tissue.

The survey, costing \$200,000 each year, will be conducted by volunteers from the Service Employees International Union.

Computer Crime

Whodunit? Computer crime is on the rise, and the accusatory finger points at company workers—not outside forces, as some TV shows and movies would have you believe.

Computer crime encompasses using the office

computer for personal gain, copying information for private use, accessing company files without permission, and playing games on company time.

Austin Weber, editor of *COMP-U-FAX*, says that although "it's hard to put a dollar figure on crime," the industry reports losses totaling \$125 million to \$250 million each year because of computer abuses.

Twenty-one percent of those responding to a *COMP-U-FAX* survey of Data Processing Management Association (DPMA) members indicate that most abuses were committed by company employees: programmers, systems analysts, machine operators, and data-entry clerks. According to the survey, their MO's were: ignorance of proper professional conduct (27 percent), misguided playfulness (26 percent), personal gain (25 percent), and maliciousness or revenge (22 percent).

INSIDE OUT

- Not so fast.** . . Computer-law specialist Jonathan Joseph, of Rosen, Wachtell & Gilbert in San Francisco, says Stephen Jobs' 11 percent holding of Apple stock provides significant protection against a hostile buyout. He says, however, that an unfriendly takeover "would not be impossible," and Apple should be wary of corporate raiders.
- Off to market.** . . John Sculley promises more marketing programs for the //e and //c in 1985. He refuses to "arbitrarily restrict" them to education and home markets.
- Climbing the charts.** . . AppleWorks made Apple Computer the sixth largest software publisher last year, according to Future Computing, Inc.
- Downturn.** . . InfoCorp reports a steady erosion of Apple's market share in retail channels. The California-based research firm notes that in May 1984 Apple won 47 percent of the market, as opposed to IBM's 31 percent. By May 1985, Apple's share had slipped to 39 percent, while IBM remained at 31 percent. "The slack is being taken up by Compaq, Hewlett-Packard, AT&T, KayPro, and lots of little guys," a company spokesperson says.

—Wendy Lea McKibbin
inCider staff



Weber says most employees don't know they're abusing computer time, so many companies are fighting crime through awareness campaigns.



Music Makers

Technology stands still for no musician. And that's why Roland, an electronic-musical-instrument design company, has been sponsoring a series of seminars on the latest in electronic-music technology.

Interest in the marriage between computer and music stems from a technological standard called MIDI (Musical Instrument Digital

Interface) information. According to Nancy Kewin, director of communications and education, electronic-music technology "makes music more tangible, more accessible for people."

The company recently concluded an 11-city tour of its one-day seminars that "educate people in the various applications of computer music," Kewin says. While the seminars explored electronic music in

recording, composition, performance, computers and music software, and audio-visual production, Kewin says future seminars will stress hands-on workshops and specialized training sessions.

Those interested in the seminars or a textbook and audiotape package of the Electronic Music Seminar

materials should send \$49.95 to RolandCorp US, 7200 Dominion Circle, Los Angeles, CA 90040.

We're always looking for news of the Apple world. If you're making news, send your press releases and photographs to News Line, inCider, 80 Pine Street, Peterborough, NH 03458.



CALENDAR

October 4 FIFTH ANNUAL COMPUTER CONFERENCE FOR EDUCATORS

Indianapolis, IN
contact:
Carol Vodde
ICE Conference '85
1200 South Barr Street
Fort Wayne, IN 46802
(219) 425-7602

October 5-8 SYMPOSIUM OF SMALL COMPUTERS IN THE ARTS

Philadelphia, PA
contact:
Symposium
P.O. Box 1954
Philadelphia, PA 19105

October 7-10 USING MICROCOMPUTERS IN GOVERNMENT

Denver, CO
contact:
Conference Manager
U.S. Professional
Development Institute
1620 Elton Road
Silver Spring, MD 20903
(301) 445-4400

October 10-12 COMPUTERS AND CHILDREN: WHAT LIES AHEAD

Ann Arbor, MI
contact:
Laura Skidmore
Center for Human Growth
and Development
300 North Ingalls Building,
10th Floor
The University of Michigan
Ann Arbor, MI 48109
(313) 763-3717

October 12 COMPUTER EXPO '85

Cranford, NJ
contact:
Union County College
1033 Springfield Avenue
Cranford, NJ 07016
(201) 276-2600

October 28-29 PACIFIC NORTHWEST COMPUTER GRAPHICS CONFERENCE

Eugene, OR
contact:
Paul Katz
Conference Manager
University of Oregon
Continuation Center
Atrium Building, Suite 333
99 West 10th Avenue
Eugene, OR 97401
(800) 228-6891
(800) 524-2404, in Oregon

Screen Tests

You can judge an RGB monitor by its color—and by its brightness, resolution, dot pitch, and more.

by Bill O'Brien



Sociologists may deliberate about the number of hours we spend in front of the computer screen, but for us, all that matters is how well we see the images flashing before our eyes.

If you've ever tried to destroy 3000 aliens on a monochrome monitor, you already know it's no fun. An RGB color monitor, however, enhances your Apple's graphics applications. You're given more options in word processing—black letters on a green screen, for example. For business use, RGB color enhances your tables, charts, and figures. In education applications, sharp color captures children's attention and encourages interaction.

Rather than accept a premixed (composite) color signal, standard on Apple II computers, an RGB monitor is fed separate red, green, and blue signals along with the information needed to organize those colors into a usable display of eight colors. The colors are brilliant, and 80-column text displays are as sharp as those found on any better-quality monochrome monitor.

Prehistoric Times

Originally, RGB monitors were quite expensive—\$800 to \$1000 for one of moderately good quality. Today, you can buy a decent RGB monitor for \$500 to \$600. Apple has its own 80-column, 64K-expansion, and RGB-display-board combination. Many RGB monitor manufacturers make Apple-compatible RGB interface boards. The barriers to bright colors

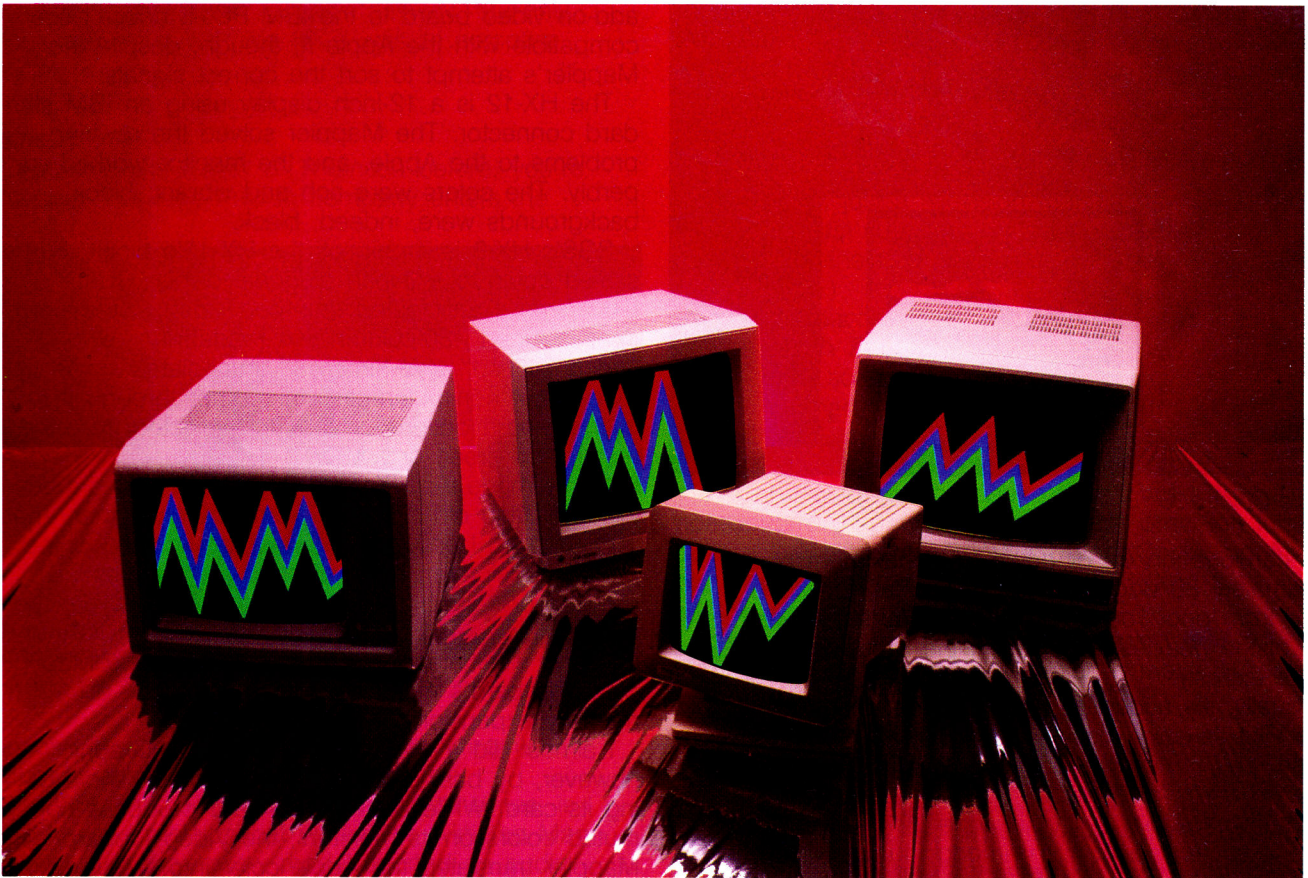

and crisp text displays have fallen, which is a good reason to see what's available.

Setting the Standards

But you'll soon find yourself up to your keyboard in RGB monitors. To help you decide, I reviewed seven monitors (see the **Table**) in three screen sizes: 9, 12, and 13 inches. Some of the monitors are specifically designed to use Apple's standard digital approach to RGB displays. Others, catering to the IBM PC market, can't be plugged directly into an Apple RGB display module, because they use a different connector. In addition, the required synchronization signals aren't the same as those generated by the Apple. To surmount this little problem, I borrowed a Mapper RGB converter from Video-7; this device makes Apple-originated signals compatible with IBM-oriented monitors.

Some manufacturers offer a third mating option—a nondescript connector capable of handling a variety of RGB inputs. In those cases, the connecting cable determined the monitor's compatibility.

For this review, Video-7 also supplied the RGB-interface modules that process the Apple's raw video. While its Apple //e model is identical to Apple's RGB combination board (both cards have a Video-7 copyright), Video-7 also has an RGB interface for the Apple //c. The Mapper works with the //c module, but because the Mapper is an unenclosed PC board designed for connection inside the //e's back panel,

inCider

Video-7 doesn't recommend it for the transportable //c.

Under Scrutiny

To uphold truth in testing, I adjusted each monitor to yield the same brightness and contrast. Using International Apple Core's Disk #45—a public-domain copy of the game Defender—I performed subjective tests and submitted each monitor to a gruelling half hour of shoot-'em-up action, complete with multi-color laser blasts and explosions.

The objective and subjective results should indicate the quality of RGB monitors. Watch out for resolution, however. In double-hi-res mode, the Apple can display 560 by 192 dots. Typically, most monitors handle a screen resolution of 640 by 240 dots. You might be tempted by the "more is better" philosophy, but a monitor with resolution as good as that your computer provides is more than adequate. It's usually a waste to spend more money just because a monitor has a higher resolution.

Also compare dot pitch, the size of each dot on the screen: the smaller the number (usually in hundredths of millimeters), the better.

The Line-up Apple

When you turn on Apple's Color 100 you hear a sound that might accompany the start-up of a dynamo. Inside, a motor operates a tilt screen which



Apple Color 100

you can position up or down to a maximum of approximately 30 degrees from horizontal, to offset glare from poor room lighting. (Of course, it was one of the heaviest monitors in the group because of the extras.)

Visually, it's accurate. Reds are red, blues are blue. But its color display isn't outstanding. Although I held it as the standard by which to judge the other monitors (as intangible as that may sound), the images lacked vitality, especially the yellows. For text work, you can select from among four default character colors from the RGB-interface board (the Video-7 board allows green, amber, blue, or white) or choose green from a switch on the monitor.

The Apple logo is a driving reason to buy the Color 100. While most dealers service the merchandise they sell, Apple products have traditionally enjoyed a quicker turn-around time for repairs. Also, the Color 100 is directly compatible with standard Apple RGB interfaces, alleviating the expense of a Mappler.

Princeton Graphic Systems

Princeton Graphic Systems has made quite a name for itself in the IBM world as a supplier of quality—yet cost-conscious—video displays. The SR-

12 is a super hi-res display designed for a special add-on video board to the IBM PC. It doesn't seem compatible with the Apple II, though, despite the Mappler's attempt to sort the correct signals.

The HX-12 is a 12-inch display using an IBM standard connector. The Mappler solved the rewiring problems to the Apple, and the monitor worked superbly. The colors were rich and vibrant; black backgrounds were, indeed, black.

PGS's HX-9 is a chip off the HX-12's block, but scaled down to a 9-inch diagonal display. It surprised me. I anticipated cramped video and major concessions to 80-column text readability. I was wrong. "Crisp" and "intense" immediately came to mind. The monitor handles text either through the interface-card options or a switch selected from the monitor as green or amber.

Clarity made the HX-9 my favorite. Its tilt/angle adjustable stand didn't detract from its utility, either. The only problem I encountered was an annoying whine from a transformer, but it stopped five minutes later.

Princeton Graphic also shipped a PGS-80 card, which offers plug-compatible connectors for its monitors and eliminates the extra expense of the Mappler. The card's major drawback is its lack of memory expansion.

I almost did a disservice to Princeton Graphic, however, by basing the review on screen shots using its card. While the PGS-80 card produces pale, muted colors on its monitors, the Video-7 board/Mappler translated the Apple color into a striking royal blue on both Princeton Graphic monitors. Princeton's card produced a shade only slightly more intense than sky blue.

Princeton Graphic added a puzzle: The HX-9 has an Apple-IBM switch on the back, and you can correctly cable it without a Mappler. Instinct normally dictates that you set the switch to "Apple." Doing so, however, distorts and muddies the color values, degrading the visual impact.

In the "IBM" position, without the Mappler, there is a small difference in some color values, but they

Table. Comparison chart for seven RGB color monitors.

Monitor	Manufacturer	Price	Screen Size
Color 100	Apple	\$599	12"
HX-12	Princeton Graphic	\$695	12"
ZVM-135	Zenith	\$599	13"
Color 500	Amdek	\$525	13"
HX-9	Princeton Graphic	\$650	9"
CV36432SI	Thomson	\$499	14"
SC-200	Sakata	\$599	13"



Princeton Graphic Systems HX-12

are still vibrant. If you do forego the Mapper, keep the switch in the "IBM" position anyway. My only serious complaint with the HX-9 was its comparatively high price.

Thomson

If you've never heard of Thomson before, you're not alone. This new French company enters the

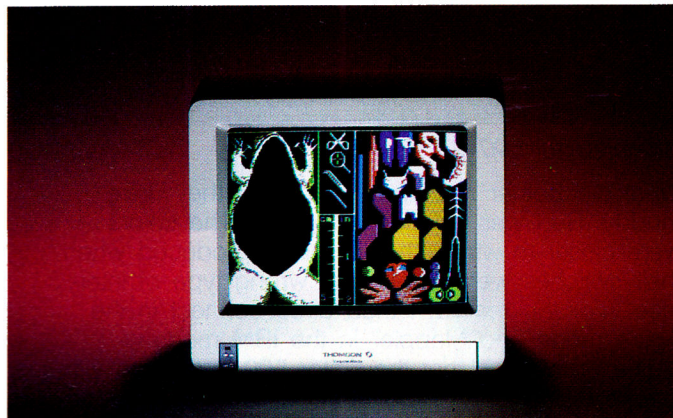

Thomson CV36432SI

American monitor market with 15 monochrome, composite color, and RGB monitors. The CV36432SI, from Thomson's professional series, is an IBM-based monitor that works fine with the Mapper. Although the review model sported an audio input, it had no composite-video input line. That's an odd arrangement, but no one says you absolutely must have composite video.

For fairness' sake, the review model was an advanced-release, pre-production model, which may account for some oddities in the brightness and contrast controls. After I adjusted the controls, things coalesced into a new degree of light or dark. Thomson probably used the wrong variable resistors for the brightness and contrast controls in only the pre-production model.

Actually, it's not a bad monitor. When everything was in place, the result was a very pleasing display that fell a hair short of Zenith's ZVM-135 in color quality. This monitor is no slouch, and its down-ranged pricing makes it very attractive.

Zenith

Zenith isn't just a television manufacturer. It was one of the first suppliers of 12-inch green-phosphor monitors for the II Plus. (Though inexpensive, they were terrible.)

I almost reached for my sunglasses when I flipped on the Zenith ZVM-135 and powered up the Apple. The 13-inch screen came alive with color. Subjectively, it earned a slight edge over the HX-9. For straight text, you can select between green and white characters.

The connector on the back of the ZVM-135 is a nonstandard 25-pin. Zenith has made provision for quite a few different computer brands, including Apple. The correct cable is a ZVM-135-3, and there are no additional switches to set.

Unfortunately, the monitor was shipped with an IBM cable that required a Mapper to make it Apple-



Zenith ZVM-135

■ Blue indicates which special features accompany monitor.

Video Characteristics				Special Features				Interface Characteristics			
Lines	Char. per Line	Resolution	Dot Pitch	Anti-Glare	Composite Video	Sound	Tilt Screen	Apple	IBM	Other	Cable Supplied
25	80	see note*	.38mm								
25	80	690 × 240	.31mm								
25	80	640 × 480	.43mm								
25	80	560 × 240	.51mm								
25	80	640 × 200	.28mm								
25	80	560 × 240	.43mm								
25	80	640 × 240	.39mm								

*Apple states resolution in scan lines. The Color 100 has a 600-line resolution at the center, 416 at the corners.

compatible. It would have been interesting to try what Zenith considers the correct cable to see if the color varied.

If you ever tire of your Apple and desire additional entertainment, the ZVM-135 is compatible with your VCR's composite video (via a rear slide switch) and will also accept an audio input, amplify it, and let you listen from a built-in speaker. Zenith includes an audio-output line if you prefer not to use the Apple speaker.

Amdek

Amdek is an old friend. I've been using the Color I composite monitor on my VCR, and the Color II RGB monitor was my only choice when I needed a quality RGB color monitor for another computer. So, I was more than eager to see the Color 500, which is from a new series of monitors that are both Apple- and IBM-compatible. I should have tempered my eagerness.

A quick look at the comparison chart reveals that the Color 500's horizontal resolution is slightly lower than that of most of the other monitors tested. But that's not the problem. The monitor's resolution is well within the capabilities of the Apple's resolution.



Amdek Color 500

What did bother me were the colors; they were muddy. Red was a forlorn magenta. The colors were closer to what other monitors produced when their switches were set for the wrong type of interface. (For the record, I tried direct-connect in the Apple mode and Mapper in the IBM mode.)

The problem is that the Color 500 is packed with features. It touts an RGB input, a separate line for composite video, and additional lines for audio and video signals from your VCR. (You can select RGB/Composite through a rear panel switch, while VCR can be punched up from the front, no matter which of the other two modes you're in.) The composite and VCR modes produce brilliant colors. And there's the surprising audio punch from its internal speaker. If you need the versatility, the RGB let-down might be tolerable.

Sakata

The Sakata 200's interface is IBM standard, requires the Mapper, and has a 13-inch screen, but that's about it. There's nothing outstanding about the monitor.

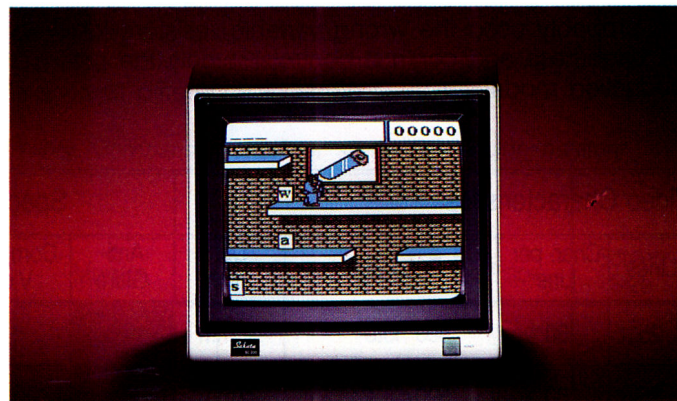

Sakata SC-200

The timid colors don't help the Sakata 200. Nor does the lack of a contrast control make the less-than-black background more than marginally tolerable. Overall, it's a lower-quality monitor—though its price hardly reflects that—and I can't recommend it.

Heartless I'm not. I talked to Sakata representatives, and they, too, recognize the monitor's shortcomings. A new model, the SC-150, is scheduled for August release. It promises a black-matrix tube

Product Information

Color 100

Apple Computer
20525 Mariani Avenue
Cupertino, CA 95014
(408) 996-1010
\$599

Reader Service Number 313

HX-9, HX-12

Princeton Graphic Systems
170 Wall Street
Princeton, NJ 08660
(609) 683-1660
\$650, \$695

Reader Service Number 316

Color 500

Amdek
2201 Lively Boulevard
Elk Grove Village, IL 60007
(312) 595-6890
\$525

Reader Service Number 314

SC-200

Sakata
651 Bonnie Lane
Elk Grove Village, IL 60007
(312) 593-3211 in Illinois
(800) 323-6647 outside Illinois
\$599

Reader Service Number 317

CV36432SI

Thomson
330 Washington Street
Suite 509
Marina del Rey, CA 90292
(213) 821-2995
\$499

Reader Service Number 315

ZVM-135

Zenith
1000 Milwaukee Avenue
Glenview, IL 60025
(312) 391-8869
\$599

Reader Service Number 318

THE MOUSE JUST LOST HIS DESK JOB

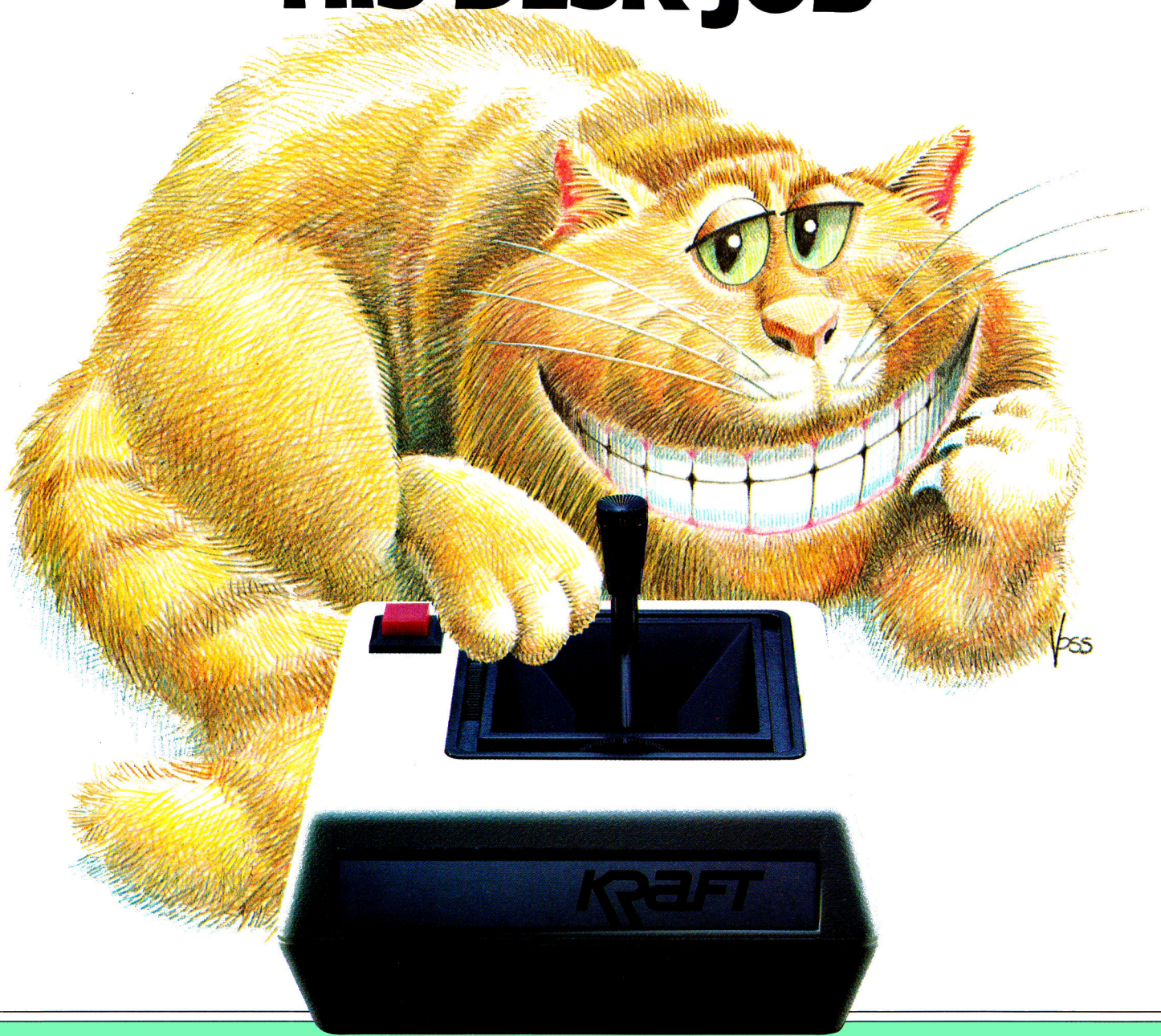

The mouse was on the ball at first. Until he met his match. New QuickStick by Kraft.

One control with two functions. The smarts of a mouse, the speed of a joystick.

QuickStick does it all for Macintosh and Apple IIc users. Combines work and play. Combines versatility and value.

Flick a switch and it works like a mouse, tracks like a mouse. But the beauty is, it doesn't drag like a mouse. So you're not glued to a desktop corner.

QuickStick™

Flick the switch again, and instantly it's a joystick. Up and ready to pounce into fast-action software.

Use it either way, switch back and forth, and you save time. You save money. At \$79.95, QuickStick puts you ahead of the game.

And has other controls by the tail.

For dealer information, call (800) 854-1923. In California call (800) 542-6436. Or write 450 W. California Ave., Vista, CA 92083.

KRAFT SYSTEMS
A division of Carlisle Corporation

QuickStick's built-in microprocessor provides 4 times the graphics resolution of a mouse. Compatible with all popular mouse and joystick software for Apple IIc and Macintosh.

Circle 231 on Reader Service Card.

and composite/sound capability at \$90 less than the SC-200. The dot pitch will increase to .42mm on the SC-150, but you might want to look at it first.

And the Winner Is...

When I started this comparative review, I convinced myself there was no way to select a clear-cut "best" RGB monitor—or even attempt to establish a hierarchy, for that matter. I was wrong. If you can afford the \$650 price tag, Princeton Graphic's HX-9 is an outstanding choice. It beats the rest by a wide margin. Ranking a solid second on the list is Zenith's ZVM-135. But if you want to save \$100—and sacrifice a bit of color vibrancy (but add an additional 1 inch of diagonal viewing area)—seriously consider Thomson's CV36432SI. (By press time, Thomson promises a shorter model designation.)

Your individual needs will dictate the monitor you choose, but consult the comparison chart before you open your wallet. ■

Write to Bill O'Brien at P.O. Box 1010A, Fort Lee, NJ 07024.

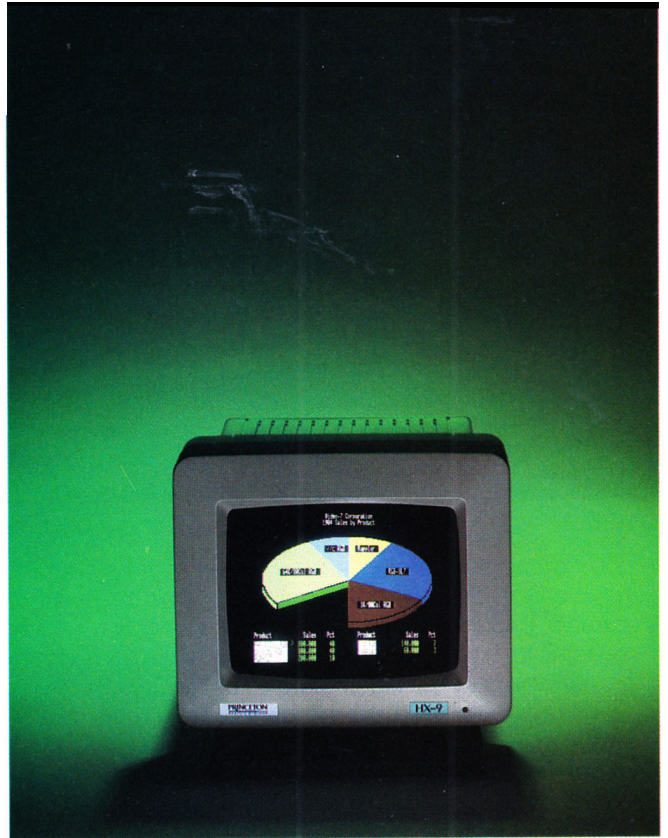

Princeton Graphic Systems HX-9

BACK UP YOUR DISKS

NOW AVAILABLE AT YOUR LOCAL COMPUTER STORE

ESSENTIAL DATA DUPLICATOR III™

EDD runs on Apple II, II plus, IIe, IIc and Apple III (in emulation mode) using one or two disk drives.

EDD allows you to easily and quickly make back up copies of your "uncopyable" Apple disks. ■ Since EDD has been preset to copy the widest range of copy-protections possible, you just simply boot up EDD, put the disk you want to copy in one disk drive and a blank disk in the other (EDD will work using one drive also) and in about 2 ½ minutes a copy is made. ■ Unlike the "copy-cards" which only copy "single load" programs, EDD copies the entire disk. This would be similar to hooking up two cassette recorders, playing from one, and recording to the other. ■ We have even included an option so you can check the speed of your disk drives because drive speeds running fast or slow can damage disks and cause other problems.

■ We publish EDD program lists (information about copy-protected disks) every couple of months, which EDD owners can receive. The current list is included with the purchase of EDD. ■ The bottom line is this; if EDD can't copy it, chances are nothing will.

\$79⁹⁵

Ask for EDD at your local computer store, or, to order direct: send \$79.95 plus \$2 shipping (\$5 foreign). Mastercard/Visa accepted. Prepayment required.

UTILICO MICROWARE
 3377 Solano Ave., Suite #352
 Napa, CA 94558 (707) 257-2420

Warning: EDD is sold for the sole purpose of making archival copies ONLY.

From Origin, source of the classic,
award-winning Ultima™ series, comes

AUTO DUEL

A futuristic, fast-paced strategy role-playing game by Lord British and Chuckles. Based on the award-winning Car Wars® board game by Steve Jackson.

Drive the freeways of the future where the right of way goes to the biggest gun. Somewhere within the 16 cities and outlaw-infested highways are the clues you will need to complete the ultimate mission.

Step into the arena on Amateur Night and earn the right to custom-build your combat vehicles.

The AADA will offer you courier missions. The FBI and the underworld will vie for favors. But watch out! To survive you'll need road experience, the ability to decipher clues, gambling skills, money, a super car—even a clone.

The final gauntlet will test your tactical skills and hair trigger reactions to the limit. But with triumph comes honor, and entry into the elite circle of AutoDuellists. The challenge of AutoDuel® awaits you. Are you ready?

Available on Apple*

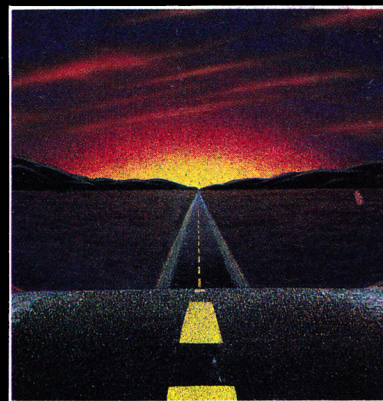

ORIGIN
SYSTEMS INC.

340 HARVEY ROAD, MANCHESTER, NH 03103 (603) 644-3360

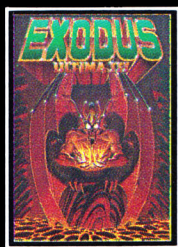

ULTIMA™ III sends you on an incredible fantasy role-playing journey through monster-plagued Sosaria in search of the elusive Exodus.

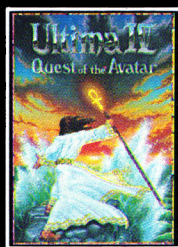

ULTIMA™ IV is the long-awaited sequel to Ultima™ III. The Quest of the Avatar is a quest to the final frontier—the self.

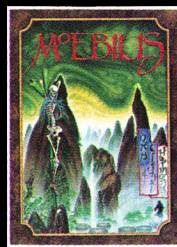

MOEBIUS™ takes you through the elemental planes of a colorful Oriental world of fantasy and adventure in search of the Orb of Celestial Harmony.

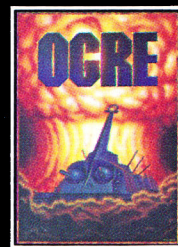

OGRE® is a strategy game fought on the nuclear battlefield of tomorrow as an inhuman juggernaut Cyber-tank battles conventional forces.

Ultima and Lord British are trademarks of Richard Garriott. Moebius is a trademark of Greg Malone. Ogre and AutoDuel are registered trademarks of Steve Jackson Games, Inc. Car Wars is a registered trademark of Texas Instruments. Apple is a trademark of Apple Computer Inc.

**Authors wanted.
Call us today.**

GETTING INTO SHAPES

Add life to your Applesoft arcade games with basic vector-shape animation.

by Bob Ryan, *inCider* Technical Editor

I've never met a programmer who hasn't dreamed of writing the ultimate arcade game on his or her Apple. But I have met precious few who've demonstrated much understanding of Apple graphics beyond HPLLOT and HCOLOR. Like "The Wall" in a marathon (that physical and psychological point in a race that can break the best runners), graphics animation seems to be a barrier breached by few programmers. Listening to them, you'd think that the only way to produce arcade animation is to use assembly language. I intend to show that arcade-style animation is well within the reach of all but novice Applesoft programmers.

You can choose from many animation methods on the Apple. The simplest is to HPLLOT an object, erase it (HPLLOT the object in the same location with HCOLOR set to black), and then plot it again in a different location. This method of animation is easy, but slow. Far superior is the use of shapes in animation. Shapes are discrete images you can move around on the hi-res screen. They can be drawn and erased much faster than images created with HPLLOTS.

You can use two types of shape animation on Apple computers—vector-shape animation and bit-mapped (or block) animation. Bit-mapped shapes are snapshots of a part of the Apple hi-res screen. You store them in memory and move them to a particular location on the hi-res screen as needed. Although faster than vector graphics, bit-mapped graphics aren't supported directly by any Applesoft commands—they can only be used via assembly language.

Vector shapes are stored, naturally enough, in vector-shape tables. Vector shapes consist of a series of plotting instructions that Applesoft's DRAW and XDRAW commands use to create the shape on the screen. For the programmer interested in ar-

cade-style animation, but lacking the time to devote to the study of Apple assembly language, vector graphics are the best and easiest solution.

Creating Shapes

Before you can learn how to use shapes in a game or in any other program, you must first create the shapes you want to use and put them into a shape table. Many utilities, both commercial and public-domain, do most of this work for you (see the sidebar on page 28). For the purposes of this discussion, I've converted a shape table into a BASIC program, TABLE.CREATOR (**Listing 1**, p. 104), by using the PEEK to POKE utility published in the September issue of *inCider*, page 71. When run, SHAPE.CREATOR POKES a shape table into memory and then saves the table as a binary file called DEMO.SHAPES.

Once you have the shape table on disk, just follow along as I show you how to manipulate the shapes and make a simple arcade game. Then you can use these principles in other graphics-animation applications.

Memory Maneuverings

Before your program can use a shape table, it has to transfer the table from disk to memory. With DEMO.SHAPES, the shape table created with the program TABLE.CREATOR, you accomplish this as follows. First type in:

```
10 PRINT CHR$(4)"BLOAD DEMO.SHAPES,A36865"
```

To keep the shape table from being clobbered by your Applesoft program or its variables, you should protect it by putting HIMEM (the highest address that Applesoft can access) below your shape table. Type in:

```
20 HIMEM:36864
```

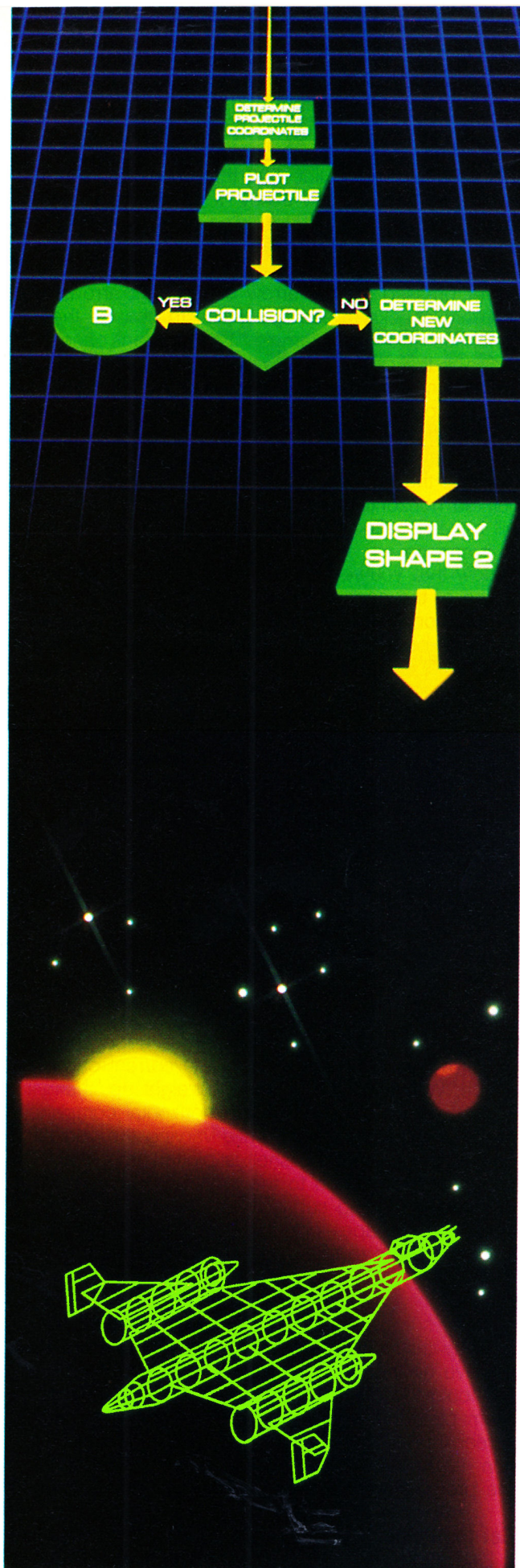
Now, to protect the Apple high-resolution graphics screen, you should type in:

```
30 LOMEM:16384
```

What the last two statements do is ensure that your shape table will not be overwritten and that Applesoft will store the contents of your variables above hi-res screen 1. (The program doesn't use screen 2.) What these statements *don't do* is ensure that your program won't spill over into the hi-res area. This isn't a problem with the demonstration program that accompanies this article, but it could be if you go on to write a large arcade game. To totally protect the hi-res area of memory, you should load large graphics programs above the hi-res screens. For an explanation of this and other memory-management matters, see "Memory Management" in the Fudge It! column of the June 1984 issue of *inCider*, page 17.

When the shapes are safely in memory, you have to tell Applesoft where to find them. You must POKE the starting address of the shape table into locations 232-233. The following statements tell Applesoft that the shape table begins at the address used in the last BLOAD command—in this case, 36865.

If you're using DOS 3.3, type in:

```
40 POKE 232,PEEK(43634)
```

and

```
50 POKE 233,PEEK(43635)
```

When using ProDOS, type in:

```
40 POKE 232,PEEK(48825)
```

and

```
50 POKE 233,PEEK(48826)
```

Now, let's see what the shapes in DEMO.SHAPES look like. Type in:

```
60 HGR:SCALE = 1
```

```
70 HCOLOR = 3
```



```

80 FOR X = 1 TO 14
90 DRAW X AT 50,50
100 FOR Y = 1 TO 2000:NEXT Y
110 XDRAW X AT 50,50
120 NEXT X

```

This little program displays a shape on the screen, erases it, and then displays the next shape in the table. The program illustrates some basic principles concerning shapes. First, you refer to shapes with a numeral or a numeric variable. DEMO.SHAPES contains 14 shapes, numbered 1 to 14. To use any other number in accessing this table will result in an "Illegal Quantity" error. The shapes themselves consist of UFOs, cannon barrels, projectiles, and some miscellaneous flying machines. I won't use all of them in my demonstration game, but you can use any or all of the shapes in DEMO.SHAPES in your own programs.

Next, note that the XDRAW command erases a shape. What the XDRAW command literally does is to draw the shape using the complement of the color currently being displayed at the coordinates given in the XDRAW command. Since black is the complement of white, XDRAW's effect is to erase the shapes.

Finally, note the use of a delay loop in line 100. You have to be careful that what you draw remains on the screen for a reasonable length of time.

Do the Locomotion

Now, let's move a shape. Type in the following:

```

80 FOR Y = 1 TO 140 STEP 5
90 DRAW 1 AT 140,Y
100 XDRAW 1 AT 140,Y
110 NEXT
120 END

```

This program causes shape 1 to "drop" from the top of the screen. You can change the rate of descent by changing the STEP value. You can move the shape horizontally by varying the x-coordinate instead of the y-coordinate. You can get it to move diagonally by varying both coordinates. Use this program to experiment with some of the other shapes in the table. I've incorporated this program, exemplifying the cardinal points of graphics animation, as the central routine in the demonstration program that accompanies this article.

Keyboard Control

Arcade games aren't passive endeavors. They require the active participation of the player. When you design an arcade game, you have to supply some means to let the player control the action.

In my demonstration game, CHICKEN.LITTLE (Listing 2, pp. 104–105), the player is cast in the role of the defender of the Earth. Alien UFOs are dropping out of the sky, and the player must destroy them before they touch down. The player gets a cannon to fight off the UFOs. The cannon barrel swivels back and forth under the control of the right- and left-arrow keys. There are actually five different shapes for the cannon (shapes 2, 3, 4, 11, and 12 in the shape table), each showing the barrel at a different angle. The program changes the cannon

shape based upon input from the player. Here's how I handle player input and use it to control the cannon shape.

After initialization, the program loops through a routine beginning in line 500 that checks to see if the player has pressed a key. If so, the routine determines which key was pressed and returns. The program then checks to see if the key that was pressed was meaningful (lines 1000–1090). If the player pressed the left arrow or the right arrow, the program checks to see if it needs to change the cannon shape. For example, if the current cannon shape is the center one (with the barrel straight up and down), and the player presses the left-arrow key, the program changes the cannon shape to the shape that has a barrel pointed slightly to the left. If the left-arrow key is pressed again, the program changes the cannon shape so that the barrel is pointed horizontally left. Another left-arrow keypress will have no effect—the cannon is as far to the left as it can go.

Now that you've seen how the player controls the shape of the cannon (how, in effect, he or she aims the cannon), let's see how the player fires the cannon and how the program plots the trajectory of the shell.

Fire Away

The last component of the keypress routine is line 1080, which checks to see if the player hit the space bar. The space bar initiates cannon shots. When the player hits the space bar, the program jumps to line 2000.

In lines 2000–2040, the program determines where the cannon is pointing by determining which of the five cannon shapes is now appearing on the screen. It then sends program control to the appropriate shooting subroutine. If, for example, the cannon is aiming straight up (that is, the current cannon shape, stored in the variable P, is 2), the program jumps to the routine in lines 2100–2140, which plots the shell's trajectory. The trajectory is under the control of an equation that reflects the current cannon shape. With the barrel pointing straight up, the equation (line 2110) keeps the horizontal component of the shell plot constant while varying the vertical component so that the shell is plotted from the mouth of the cannon to the top of the screen. In all of the shell-plotting subroutines—there is one for each barrel shape—one line (line 2120 in this instance) checks to see if the shell intersects the UFO, scoring a hit. Hit detection is pretty simple. The program compares x and y coordinates of the UFO and the shell. If the coordinates of both are fairly close (within ten, in this case) the shell is considered to have hit the UFO.

Should the player fail to hit the target, the program plots the shell's movement to the edge of the screen under the control of the shell-plotting equation. If, on the other hand, the player scores a hit, the program jumps to a scoring routine at line 4000.

Get the Points

Like all arcade games, the object of my demonstration game is for the player to rack up as many

How to get the most bytes out of your Apple.



Read why Steve Wozniak recommends RamWorks™ expansion cards.

The machine that Woz built is a powerful business computer. AppleWorks gave it a potent 1-2 combination. Now, RamWorks has added the knock out punch. With RamWorks expand the total memory of your IIe up to an incredible 2.5 MEG. Your AppleWorks will no longer be limited by the amount of factory supplied RAM. And you'll be able to perform virtually any application you want with far greater speed and ease.

How AppleWorks works best with RamWorks.

RamWorks plugs into the IIe auxiliary slot and acts just like Apple's extended 80 column card. If you buy a 256K or larger card, AppleWorks will automatically load itself into RamWorks. This dramatically increases AppleWorks' speed because it effectively eliminates time required to access disk Drive 1. Now, switch from word processing to spreadsheet to database management at the speed of light. AppleWorks responds the moment your fingers touch the keyboard.

But AppleWorks has certain internal limits, independent of available memory. Fear not. Only RamWorks removes those limits with a proprietary, easy to operate program that "patches" onto the boot disk in seconds. Only RamWorks increases the maximum number of records available to you from 1,350 to over 5,000. And only RamWorks actually increases the number of lines permitted in the word processing mode.

Plus, when you create an AppleWorks file larger than your disk capacity, only RamWorks automatically segments it to the appropriate size. RamWorks then prompts you to insert more disks, so you can save any size file on regular floppies or hard disk.

The most friendly, most expandable card available.

RamWorks is compatible with more off-the-shelf software than any other RAM card. Popular programs like Magic Office System, Flashcalc, The Spread Sheet, Diversi-DOS, Supercalc 3A, Magicalc, etc. (And hardware add-ons like Profile and Sider hard disks.) Fact is, RamWorks is 100% compatible with all software written for the Apple 80 and extended 80 cards. In addition, RamWorks can emulate other RAM cards, so you can use



"I wanted a memory card for my Apple that was fast, easy to use, and very compatible; so I bought RamWorks."

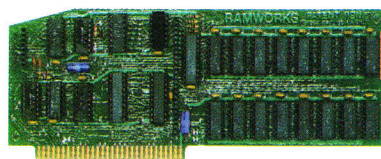

programs written for them without modification.

RamWorks was designed so you could take full advantage of future developments in 16 and 32 bit microprocessors. As your needs grow, so can RamWorks. A handy expansion connector allows the latest and greatest co-processor cards to access RamWorks' memory. And allows you to piggyback another 2 MEG. Clear instructions show you how to plug in more memory.

For only \$129 you can add an RGB option to your RamWorks and get double high resolution color graphics. All with a super sharp brilliance that's unsurpassed in the industry.

More features than you can shake a mouse at.

A word from the Woz should be sufficient. Because there's only one card like RamWorks. Imagine how you will benefit from these features: • 15 DAY MONEY BACK GUARANTEE • Sharp 80 column text (with or without RGB option) • Double high resolution graphics (with or without RGB option) • EXPANDABLE TO 2.5 MEGABYTES • Can use 64K or 256K RAMs in any combination • Adds memory to AppleWorks • Co-processor connector • Accelerates speed of AppleWorks • 100% COMPATIBLE WITH ALL IIe SOFTWARE • RAM disk software available (compatible with Applesoft, PRO-DOS, DOS 3.3 and PASCAL—\$29) • RAM disk available for CP/M (\$29;

included with our CP/M card) • RGB color option • Takes only one slot • FIVE-YEAR NO HASSLE WARRANTY.

RamWorks with 64K (\$179); 128K (\$219); 256K (\$249); 512K (\$319); 1 MEG (\$519); 2.5 MEG (\$1599). CALL 214/241-6060 TO ORDER YOUR RamWorks TODAY. (9 a.m. to 11 p.m. 7 Days, or send check or money order to Applied Engineering. MasterCard, Visa and C.O.D. welcome. Texas residents add 5½% sales tax. Add \$10.00 outside U.S.)

AE Applied Engineering
P.O. Box 798, Carrollton, TX 75006
(214) 241-6060

points as possible. Nothing motivates a game player more than seeing his or her score mount up in the course of the action. You can handle arcade-game scoring in many ways. I decided to add a scoring mechanism that not only adds points for hits, but also varies the points for hits based upon how quickly the player destroys the UFO. Hitting the UFO before it drops very far results in more points than if the player gets the UFO just before it hits the ground.

The scoring routine (starting in line 4000) first erases the UFO and the shell. It then computes a score for the hit. The routine determines the score by subtracting the target's vertical coordinate (which increases as it drops, from 140. Line 4020 displays the player's total score at the bottom left-hand corner of the screen. Then the program loops back to the start of the UFO-drop routine and repeats the sequence of falling UFOs, keyboard input, and shot plotting.

Nothing Is Forever

Life doesn't go on forever, and neither do arcade games. When you design a game, you must specify some "end" condition—some combination of events that concludes the game. I spent a lot of time thinking about how to detect when a UFO landed—needless thinking, as it turned out. Quite simply, my

game ends when the FOR. . .NEXT loop that controls the descent of the UFO completes its control function without interruption (the only cause of interruption being the collision of the UFO and a shell).

As a parting shot, I included a routine at line 5000 that "explodes" the cannon after a UFO landing. The program jumps to this routine from line 280, the line immediately following the NEXT statement of the UFO control loop. Any game you design probably won't have such a simple ending condition. I just got lucky.

Touch It Up

That's all there is to CHICKEN.LITTLE. It is not the be-all and end-all of arcade games, but it's not meant to be. It contains most of the elements and demonstrates many of the problems encountered in animation programming in general and arcade games in particular. If you're an intermediate Apple-soft programmer, you should now be able to write your own animation programs or modify my program to suit your tastes. You should be aware that many techniques, such as page-flipping and collision-counting, will increase the apparent speed of the shapes. Welcome to the never-ending world of Apple graphics. ■

Listings 1 and 2 are on pages 104 and 105.

Shape-Creation Software

Vector shapes are not difficult to use, but they can be very difficult to create. Basically, there are two methods of shape creation—you can use a shape-editing program, or you can produce shapes by hand.

The latter technique is described in the *Applesoft BASIC Programming Reference Manual* (Apple product #A2L0006), commonly known as the "green" manual. This method involves graphing your shapes on paper and converting the dots on the paper into plotting vectors. You then translate these vectors into machine-language bytes so that Applesoft shape commands (DRAW, XDRAW, etc.) can use them to re-create your shapes on the hi-res screen. Finally, you incorporate the bytes into a table, construct an index, and, using the monitor, type the table into memory. You can then save the table to disk. All in all, this procedure is troublesome enough to make you give up graphics programming forever.

Luckily, a number of commer-

cial and public-domain programs are available to assist graphics programmers. These programs normally consist of a number of modules, including a shape editor and a shape-table creator. Most shape editors give you a magnified grid on which to compose your shapes; shape-table creators put the shapes you've drawn into a shape table, complete with index.

The first shape utility I ever used was Apple Mechanic by Beagle Bros. This package contains, in addition to shape utilities, a hi-res character editor and a number of different hi-res type fonts. Apple Mechanic is a very good shape utility at a bargain price.

You can find another efficient shape utility in Pixit, a graphics package from Baudville. One of Pixit's strengths is its excellent tutorial on graphics animation. I recommend it to students of all ages.

The most respected name in Apple graphics is Penguin Software, and naturally it offers several utilities that deal with

shapes. The Complete Graphics System, for instance, provides a very capable vector-shape editor in addition to a drawing program, a hi-res character generator, and a 3-D graphics system. The Complete Graphics System encompasses the breadth of Apple graphics.

The Graphics Magician is another Penguin offering that handles shape creation. Unlike the programs mentioned above, the Graphics Magician works primarily with bit-mapped graphics. You can use one of its sections, however, to create super vector shapes.

Of course, if you can get by with minimal documentation and user-friendliness, you can also obtain a fairly good shape editor from any Apple public-domain software library. (See the list of public-domain shape utilities in the product information box on page 30.) Whatever shape editor you decide on, you can be thankful that the days of manual shape creation are gone forever. □

—R.R.

MITAC AD-3C.

The leader in high performance drives.

**FOR ALL
APPLE® II
SERIES
COMPUTERS.**

In the crowded field of second disk drives for the Apple® II series computers, one drive stands out as leader of the pack — the MITAC AD-3C.

The AD-3C is MITAC's high performance, half-height drive that comes with cable connections to perfectly mate either the IIc or the II/II+/IIe. There's even a special adaptor to convert a IIc drive to fit the IIe.

Like world class racing cars, the AD-3C is built under exacting standards to be rugged and reliable. It boasts such advanced features as fast-start DC brushless direct drive

motors and long-life read/write heads. When it comes to performance, nothing overtakes the AD-3C.

And the AD-3C doesn't get beat out in the price competition, either. In fact, when it comes to quality and price, the AD-3C stands alone in the winner's circle.

So don't settle for second best and risk getting stuck in the pack. Zoom out front with the MITAC AD-3C.

American MITAC Corp.
3385 Viso Court
Santa Clara, CA 95054
(408) 988-0258

APPLE II/II+/IIe/IIc are registered trademarks of Apple Computer, Inc.

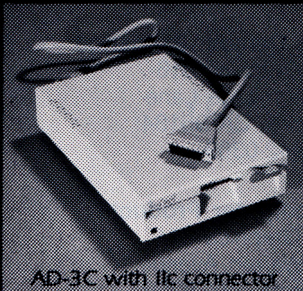

AD-3C with IIc connector

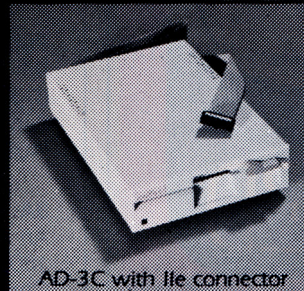

AD-3C with IIe connector

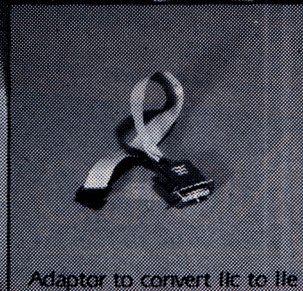

Adaptor to convert IIc to IIe

mitac

MUSIC LOVERS

Lavish yourself with the Sweet Sounds of new **MOCKINGBOARD** enhanced software.

MUSIC CONSTRUCTION SET lovers ... we've got great news for you! Now this great program is joined by three new Mockingboard enhanced programs. They will teach you music theory, how to play a guitar or a piano, as well as help you compose your own music scores. Mockingboard is the only six-voice music synthesizer that is supported by these great music programs:

- **MUSIC CONSTRUCTION SET* - Electronic Arts**
- **BASIC MUSIC THEORY - Siegfried Inc.**
- **MUSIC CONCEPTS - Ventura Educational Systems**
- **GUITAR MASTER - Mastersoft**

All of the above software runs on **MOCKINGBOARD A** which retails for only \$99.00.

PSSSSSSSSSST

That's not all! Our Mockingboard family is growing everyday. Mockingboard also enhances great games such as **Sky Fox** by Electronic Arts, **Willy Byte** by DTI Data Trek, **Exodus Ultima III** by Origin Systems, **Under Fire*** by Avalon Hill, **At the Gates of Moscow 1941** by Strategic Games and many others. Keep looking for our ads announcing the latest in music, educational and arcade software that is Mockingboard enhanced.

MOCKINGBOARD CAN ALSO TALK

MOCKINGBOARD A can be upgraded for speech synthesis with the purchase of a **MOCKINGBOARD B** Speech Upgrade. Suggested retail price \$89.00.

MOCKINGBOARD C is a **MOCKINGBOARD A** plus a **B** Speech Upgrade all in one package. Suggested retail price \$179.00. **MOCKINGBOARD A, B** and **C** are compatible with Apple II, II+ and IIe.

MOCKINGBOARD D is a stereo music, sound and speech synthesizer for the Apple IIc. Suggested retail price \$195.00. *The new **MOCKINGBOARD D** supports **Music Construction Set** and **Under Fire**. Check with your dealer for new titles that are being written for this **MOCKINGBOARD**.

To hear **MOCKINGBOARD** perform, visit your local dealer or call (401) 941-1130. For the name of your local dealer that carries Mockingboard, call 1 (800) 341-8001.

Apple™ is a registered trademark of the Apple Computer Company.

MOCKINGBOARD

SWEET MICRO SYSTEMS, INC.
50 Freeway Drive, Cranston, RI 02920

Product Information

Commercial Programs and Suppliers

Apple Mechanic

Beagle Bros
3990 Old Town Avenue, Suite 102C
San Diego, CA 92110
(619) 296-6400
\$29.50

Reader Service Number 310

The Complete Graphics System The Graphics Magician

Penguin Software
P.O. Box 311
Geneva, IL 60134
(312) 232-1984
\$79.95, The Complete Graphics System
\$59.95, The Graphics Magician

Reader Service Number 311

Pixit

Baudville
1001 Medical Park Drive S.E.
Grand Rapids, MI 49506
(616) 957-3036
\$49.95

Reader Service Number 312

Public-Domain Suppliers

A.P.P.L.E.

Disk #16
21246 68th Avenue South
Kent, WA 98032
(206) 872-2245

Computer Budget Shopper

AO16
2203 Park Avenue O.V.
Cheyenne, WY 82007
(307) 635-3173

LOGIC Disk Copy Service

A-074
P.O. Box 696, Station 'B'
Willowdale, ON M2K 2P9

Public Domain Exchange

Art & Graphics 016
673 Hermitage Lane
San Jose, CA 95134
(408) 942-0309

3A Computer Products

Art & Graphics 014
1803 Warren Avenue
Cheyenne, WY 82007
(307) 632-8561

**NEW
PRODUCT**

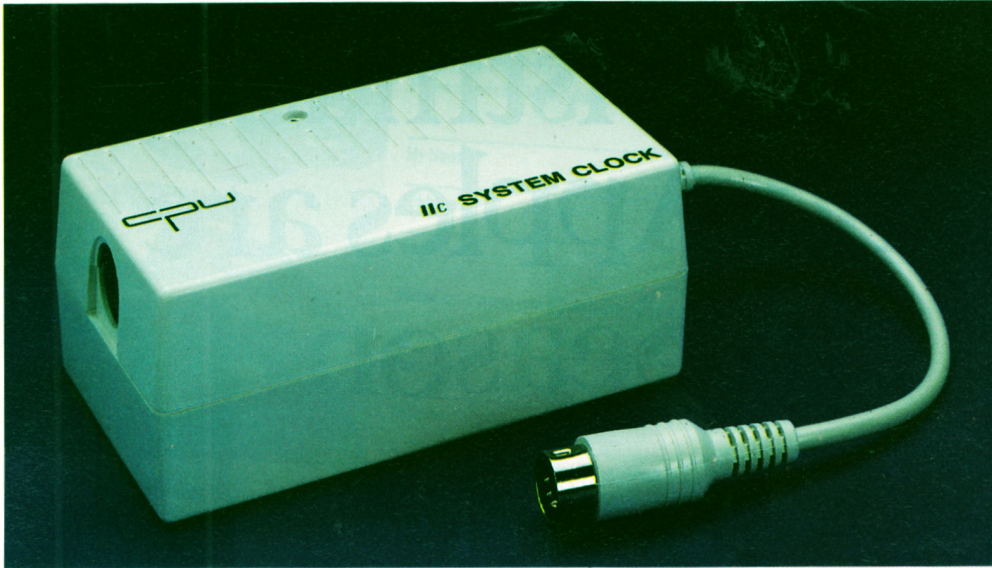

IIC SYSTEM CLOCK

- Fully ProDos compatible
- Automatic time and date stamping
- Easy to use from BASIC
- Battery operated, uses 3 "AA" batteries (will last 1-2 years before simple replacement)
- Date has year, month, date and day of week
- Time has hours, minutes and seconds
- Will time and date stamp AppleWorks files
- Will display time and date on the AppleWorks screen
- Auto access from AppleWorks data-base (just use a time and date field)
- Pass through serial port - The Iic system clock can plug into either the modem or printer serial port, then modem or printer plugs into the clock
- No hassle 5 year warranty
- Only \$79.00



214-241-6060 **"We Set the Standard"**
APPLIED ENGINEERING 9 AM - 11 PM

It's Christmas and Apples are in Season.



Christmas again. If a relative or friend owns an Apple II computer, you ought to start thinking about what to give them for Christmas.

Why not give them the most useful gift of all, **user-friendly information**. Information like that found only in **inCider** magazine, the Apple II Journal.

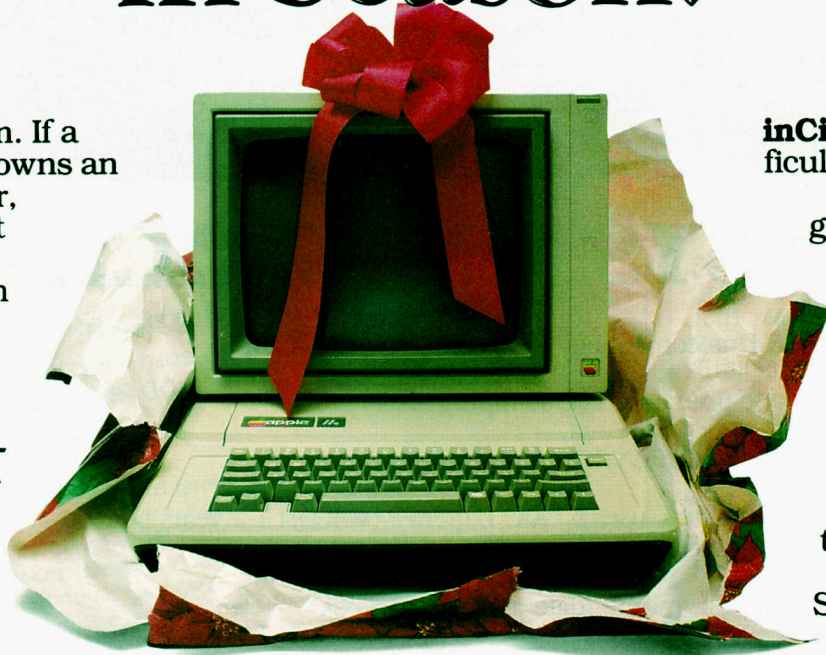

inCider takes the difficulty out of learning about Applesoft, graphics programming, assembly language, games, business and educational applications. **inCider** makes computing easier and more fun. Isn't that what gift giving is all about? So, when it comes to Christmas this year, give **inCider**.

inCider The Apple II Journal



YES! I want to give the right gift to my Apple II friends. 12 issues for \$24.97.

Payment enclosed Bill me after the holidays
(Please make checks payable to inCider)

My Name _____

Address _____

City _____ State _____ Zip _____

Please enter a one year gift subscription for:

Name _____

Address _____

City _____ State _____ Zip _____



Canada & Mexico \$27.97. 1 year only, US Funds drawn on US Bank. Foreign Surface \$44.97. 1 year only, US Funds drawn on US Bank. Foreign Airmail, please inquire. All gift subscriptions will begin with the first available issue in 1986.

65AB5

CW Communications/Peterborough • inCider • PO Box 911 • Farmingdale, NY 11737

GET YOUR FEET WET...



... IN THE INFORMATION AGE WITH THE DOW JONES NEWS/RETRIEVAL® MEMBERSHIP KIT. SAMPLE A CONTINUOUS STREAM OF KNOWLEDGE AT A PRICE YOU CAN AFFORD.

Now you and your whole family can experience the information age without getting in over your head.

For just \$29.95, the new Dow Jones News/Retrieval Membership Kit leads you step-by-step into entertaining and informative data bases. With **five free hours** to sample and explore, you can find a fact, shop at

home, get the scores, plan a trip, review a movie, choose a stock, or check world and business news. There's a lot more, too. All you need to get started is a computer and modem:

The Membership Kit is a big value that entitles you to:

- FREE password (\$75 value)
- Easy, step-by-step User's Guide
- FIVE FREE HOURS of unrestricted usage to explore the magic of this comprehensive service

- FREE subscription to *Dowline*, the magazine of Dow Jones News/Retrieval
- A special introductory offer!

Get your feet wet in the information age with the Dow Jones News/Retrieval Membership Kit. At \$29.95, you'll enjoy the dip without getting soaked. Available at your local computer retailer, or call Dow Jones at:

1-800-257-5114

**In New Jersey, Canada,
Hawaii and Alaska
1-609-452-1511**

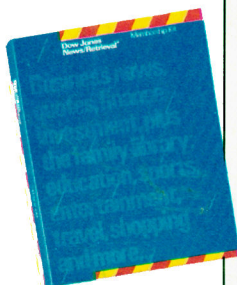

"Toss away any preconception that Dow Jones News/Retrieval is a stuffy, one dimensional data base service designed only for an elite corps of stock analysts and Wall Street wizards. Far from it—Dow Jones News/Retrieval also provides entertaining movie reviews, current weather and sports reports, convenient electronic shopping and inexpensive electronic mail... Dow Jones News/Retrieval is informative, entertaining and well worth the money."

-Brad Baldwin, InfoWorld Magazine



Copyright © 1984 Dow Jones and Company, Inc.
All Rights Reserved. Dow Jones News/Retrieval®
is a registered trademark of Dow Jones and Company, Inc.

Circle 30 on Reader Service Card.

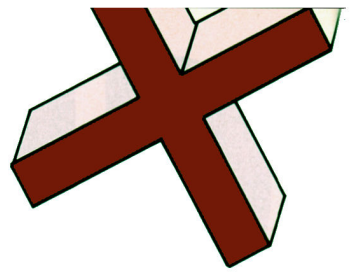
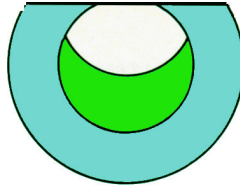

OF THE GAME

Even in tic-tac-toe, the computer that fails to remember the past is doomed to repeat it.

by R.A. Dousette

Although your computer can't "think," it can at least simulate learning. My computerized Pascal tic-tac-toe program, based on Donald Michie's MENACE (see the sidebar), helps your Apple improve its game playing by referring to previous games—won, tied, and lost.

As with Michie's version, my computerized MENACE always has the first move. Even with this restriction, more than 300 game plays are possible. As **Figure 1** illustrates, each tic-tac-toe position is logically equivalent to seven others. Rotating position 1 90, 180, and 270 degrees produces positions 2, 3, and 4, respectively, with positions 5–8 being their mirror images. Thus, a good move for position 1, when appropriately rotated, reflected, or both, is also a good move for the other seven positions. Likewise, a bad move for position 1 is equally disastrous for the other seven positions.

As the computer encounters each position, it compares that position to the ones stored in memory. If the current pattern matches one in memory, the program plays that old pattern. If the current pattern is new, the computer adds it to its memory.

A three-part record represents each pattern: A three-by-three ar-

ray contains Xs, Os, and blanks that stand for their respective positions on the playing field; a three-by-three array of integers contains the results of prior plays of this pattern; and a pointer shows the next pattern in the list.

Three linked lists—consisting of patterns the computer encounters before the third, fifth, and seventh

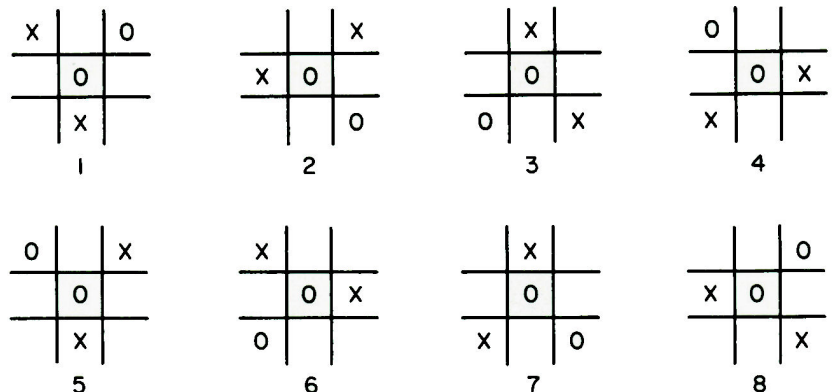
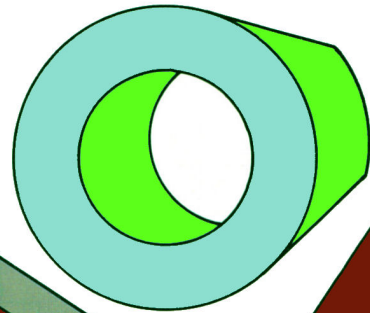
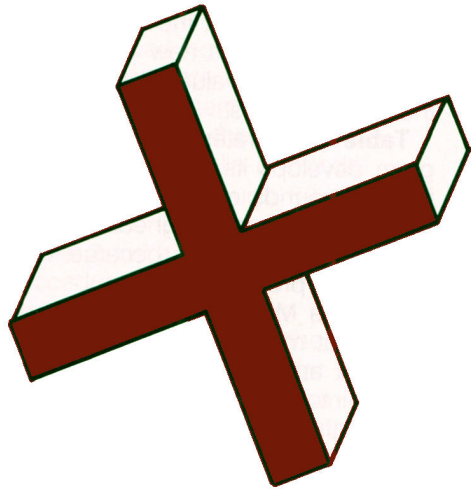

Figure 1. Eight equivalent tic-tac-toe positions.



moves—make processing data faster, as the computer doesn't have to sort through all possible patterns at each move. Instead, it looks only at those patterns that apply to the current level of play.

Suppose, for example, that MENACE begins the game by playing an X in column 2 of the third row, and you respond by putting an O in the center square (pattern 1 in **Figure 2**). Variable pointer1 indicates the first pattern in the linked list of the patterns MENACE has so far encountered. If this pattern matches pattern 1 exactly, MENACE uses its experience from this pattern to determine where to place its second X.

Pattern 2 shows the second round of play. Pointer2 indicates each pattern at this level until the computer finds an equivalent pattern (identical, rotated, or reflected as explained in **Figure 1**). The computer then places its next X (pattern 3), and pointer3 indicates

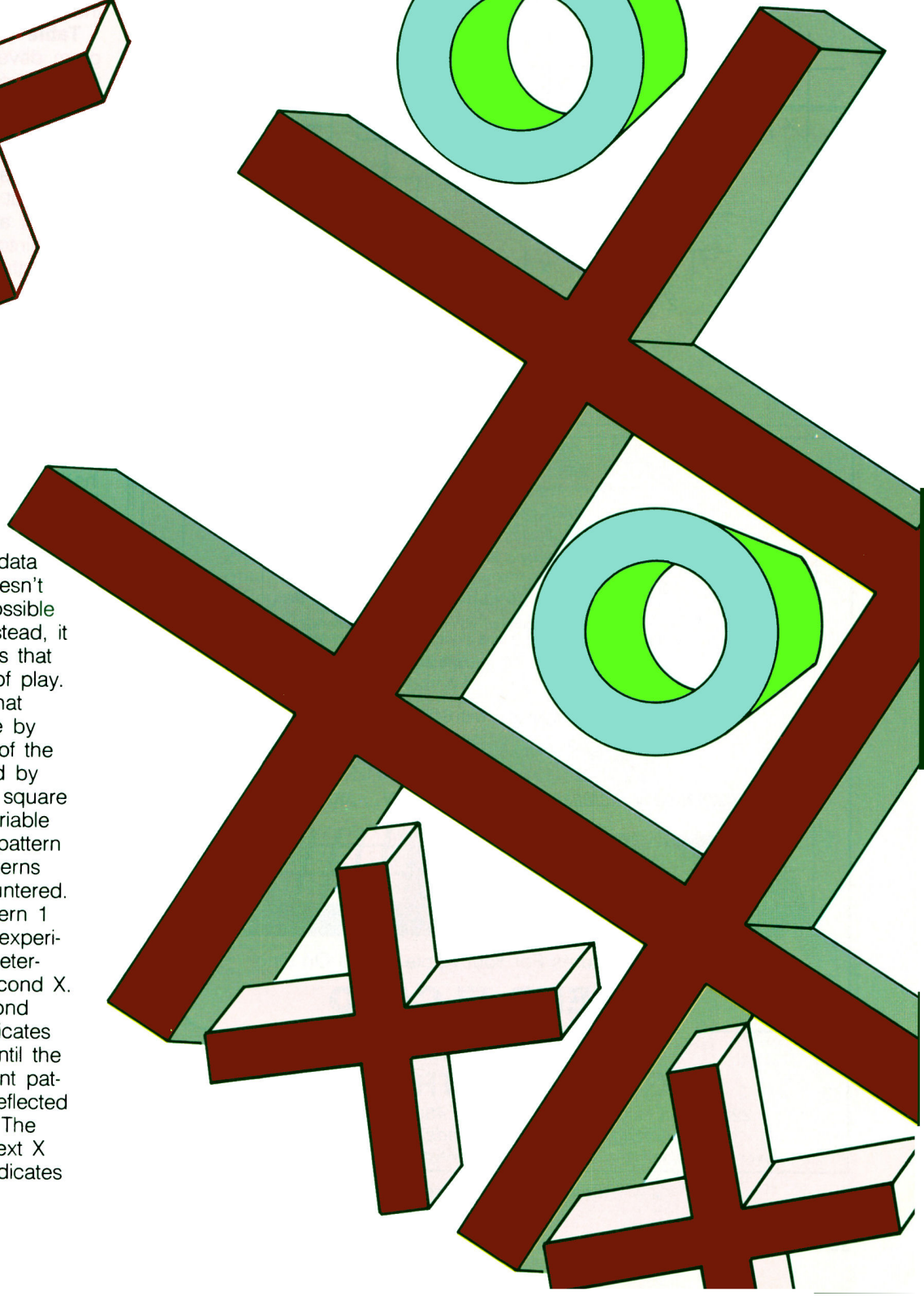
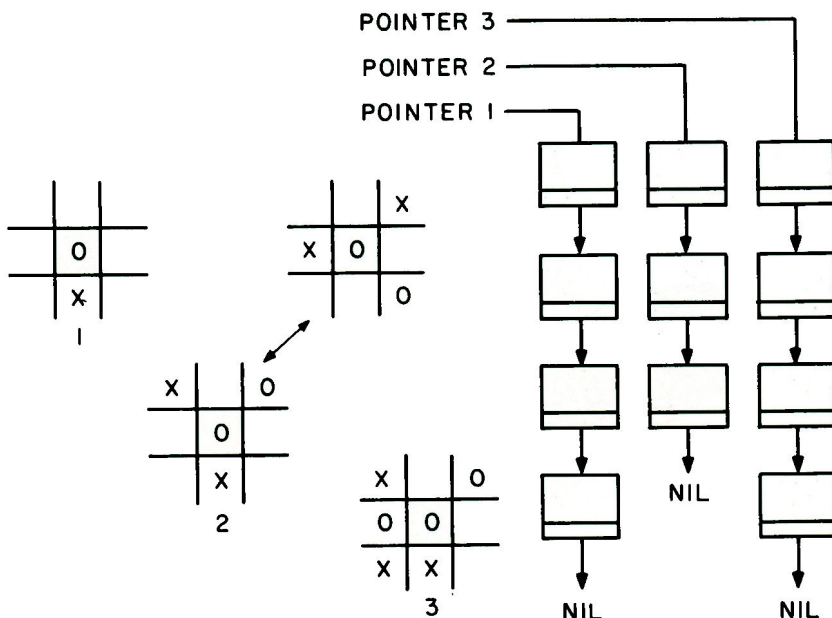

Figure 2. How MENACE chooses a move.



the list of patterns at this level. If the program doesn't find a pattern that matches pattern 3 (that is, the pointer to the next pattern has the value nil), it realizes this is a new pattern. The program updates the pointer in the fourth pattern to indicate this new pattern, and gives it the value nil to signal the end of the list.

Table 1 illustrates how the program develops its ability. In the first two rounds of 25 games each, my wins outweighed my draws, but the games became somewhat predictable.

Because MENACE chose the move that made it competent in the least amount of time, it quickly settled into a pattern of always playing the first move in the center. To avoid MENACE's possible forced win, I usually responded by playing one of the corners. This resulted in one of two sequences of play leading to a draw.

If MENACE played the corner or side as its first move instead, I had a wider choice of advantageous responses. Consequently, by the fourth round, MENACE had refined its ability to such an extent that I won only one of the 25 games.

In the fifth round, I adopted a riskier strategy. In response to the computer's center play, I placed an O in row 1, column 2. It's a chancy move because a skillful opponent can force a win from this position; the advantage arose from placing MENACE in an unfamiliar and initially confusing situation. The computer quickly learned what was happening (it increased its patterns at all levels) and once again began to win. I saw the handwriting on the wall.

In the eighth round I played irrationally. I figured that if, for example, I didn't block two Xs in a row, MENACE might not choose the correct response and would, instead, throw the game into new, unexplored territory where I might have a chance to pick up a few morsels. This strategy shift temporarily restored my wins, but the trend was definitely downward.

80 COLUMN DISPLAY
compatible with software written for Apple extended 80 column card

RGB VIDEO CAPABILITY
for display of all Apple colors

NEAR PHOTOGRAPHIC QUALITY
when using most color software on monochrome monitors, achieved by 16 tone graduations of the monochrome image

UP TO A FULL MEGABYTE
expandable memory upgraded with 64K or 256K RAM chips

APPLEWORKS EXPANSION PROGRAM
dramatically increases desktop memory... up to 735K

All These Features For Your Apple //e, All On One

LEGEND E' CARD™

Three Year Warranty!

LEGEND INDUSTRIES, LTD.
2220 Scott Lake Road, Pontiac, MI 48054 • (313) 674-0953
Turning Apples into Legends™ since 1981

Legend and E' Card are trademarks of Legend Industries, Ltd. Apple and AppleWorks are trademarks of Apple Computer, Inc.

Circle 28 on Reader Service Card.

The Listing

The **Program listing** (beginning on page 106) has uppercase code that is commented out because it slows down program execution. This code, however, provides an interesting view into the inner workings of the program. To activate the code, remove the comment symbols at the beginning of the uppercase code and recompile the code.

Columns 41 through 80 display the name of each procedure (see **Table 2** for a description of the procedures) as you enter it, the level of play, the pattern from the list being compared to the current pattern, the rotation and/or reflection of the pattern from the list, and whether or not the pattern matches the current position. The display also shows the relative weights assigned to the possible moves, the row and column of the move generated from the pattern in memory, and the row and column to which this move is rotated and reflected to become a play in the current game.

Conclusion

Watching MENACE in action reveals both the strength and weakness of this method of simulating learning. The program is responsive to good play, but MENACE can settle into a pattern in which it will play in pursuit of a draw while passing up obvious wins—exactly what you would expect from a program capable of looking only at past experiences.

MENACE eventually becomes a competent opponent, but an unimaginative one. You can, however, experiment with the program. Chapter 8, "A Matchbox Game-Learning Machine," of Martin Gardner's *The Unexpected Hanging and Other Mathematical Diversions* (Simon and Schuster) may give you some tips on how to produce an aggressive opponent. ■

The Program listing begins on p. 106.

Write to R.A. Dousette at 2509
Johnston Street, Apt. 13-4,
Lafayette, LA 70503.

inCider

Table 1. A demonstration of program play.

Round	Wins	Losses	Draws	New Patterns Encountered		
				Move 3	Move 5	Move 7
1	21	0	4	6	14	9
2	17	0	8	7	19	14
3	6	0	19	7	19	14
4	1	0	24	7	19	14
5	9	6	10	8	23	21
6	0	10	15	8	23	23
7	1	16	8	8	23	23
8	13	9	3	8	28	28
9	6	16	3	8	33	35

Z-Engine delivers CP/M® for your Apple®

Z-Engine delivers a trainload of additional programs to your Apple II, II+, IIe or Apple compatible computer. Many of the most powerful and sophisticated programs available today are CP/M based; **Z-Engine opens the door to them all.**

You might expect that something that gives so much would cost so much. Not so. Z-Engine is, undoubtedly, one of the greatest values in the microcomputer industry. Z-Engine is first class service at economy fare. Once the Z-Engine has been delivered we don't shut off the steam - we support our products - and guarantee them. **If you knew what we know about the Z-Engine you'd be our next customer.**

The Z-Engine delivers.

Advanced Logic Systems
1195 East Arques Ave.
Sunnyvale, CA 94086
(408) 730-0307.

als

CP/M is a registered trademark of Digital Research Inc. Apple is a registered trademark of Apple Computer, Inc.

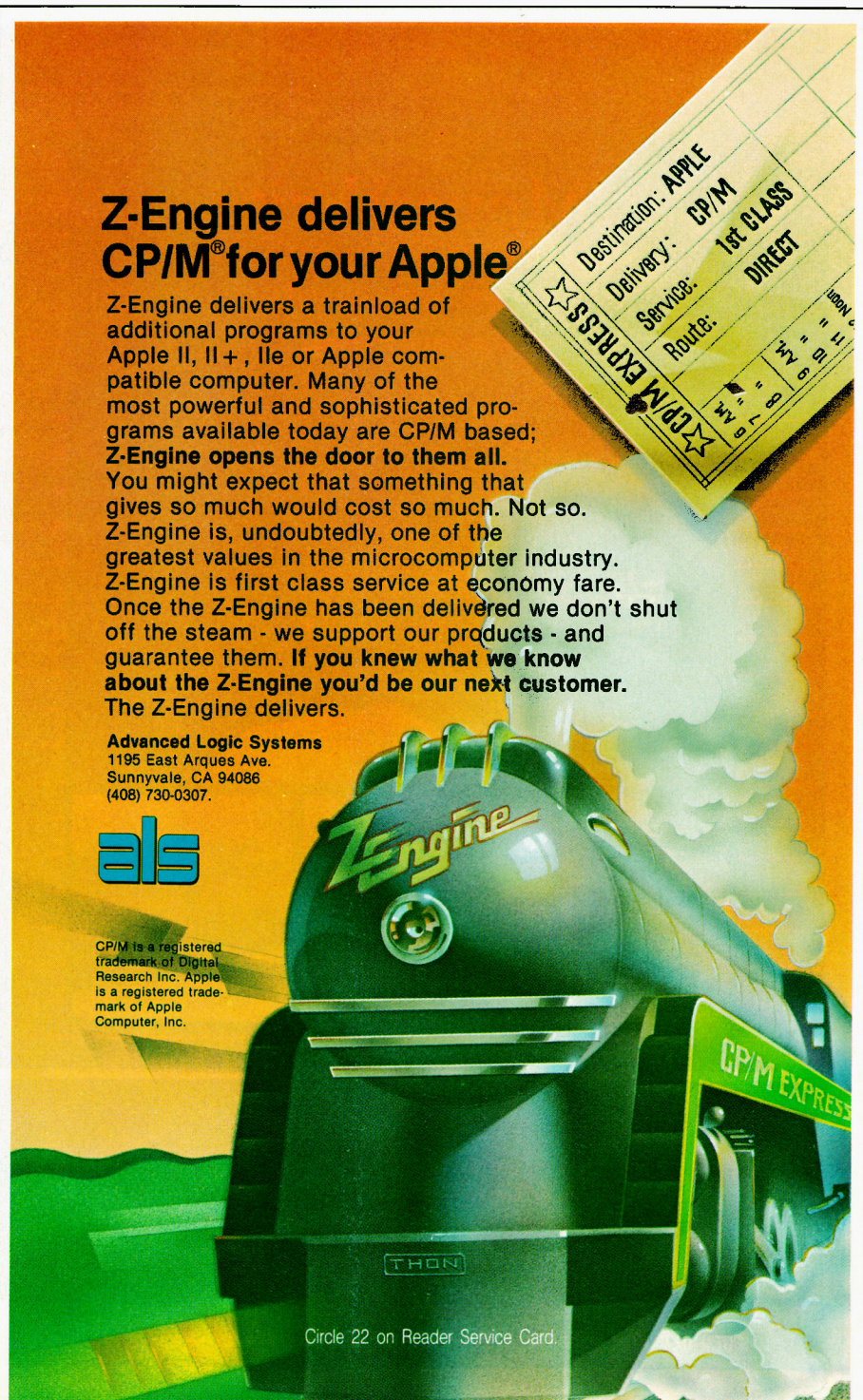

Circle 22 on Reader Service Card.

Table 2. Procedures for MENACE.

MAIN ROUTINE

Initboard

Shows the game count and the number of wins, losses, and draws; clears the array that stores the history of the game; and fills the tic-tac-toe board with blanks.

Tictactoe

Generates the computer's initial move

at move 1, and then calls function won to see the status of the game. If the game is still in progress, the procedure calls itself two moves higher. If the game is over, the variable status is given the value lose, draw, or win.

Update

Updates the experience to include the results of the most recent game.

Done

Uses a Boolean value that returns the

value true if you indicate no more games.

MOVES

Applemove

Generates the Apple's play. At move 1, the computer randomly plays in either the upper left-hand corner, the center position, or the second column of the first row. The array firstmove[i], which represents the value of each of these plays, initially equals four (each move has four chances in 12 of being chosen). As the moves result in wins, losses, and draws, their relative weights change in favor of those moves that result in wins and draws. At moves 3, 5, and 7, the pointer variable srchptr is set at the beginning of the appropriate linked list. At move 9, applemove plays the final blank space.

Humanmove

Examines the playing board to find the first blank space in the board after the computer's move, and displays a plus sign there for your move. The left- and right-arrow keys move the plus sign, and the return key or the space bar places your move in a position.

Nextblank

A subprocedure that finds the row and column coordinate of the next blank space.

Lastblank

A subprocedure that finds the row and column coordinate of the last blank space.

PATTERNS

Searchpattern

Searches the linked list for a match and randomly generates the computer's move. A "repeat...until" loop compares the game position to the one to which srchptr is pointing, and, if the position doesn't match, updates srchptr to point to the next position in the list. This continues until the program finds a match or the list is exhausted.

Newpattern

Adds a new pattern to the end of the appropriate linked list if searchpattern doesn't find a match. It also prints the value of memavail, a built-in function that shows how much memory remains to contain later patterns.

Genmove

Totals the weights of the possible moves and generates a random number to select the row and column of

MouseWrite™
The Mouse-Based Word Processor
For the Apple IIe and IIc

MouseWrite File Edit Find Move Style Page Windows
Open Second Window Quit
Close
Save
Save As
Print Document
Quit

Dear Matt:
Just a quick note to say thanks for all your help in selecting a new word processor. Frankly Matt, the one you recommended was just too complicated for me. I don't have time to learn that new computer. When my local dealer showed me a package called MouseWrite from Roger Wagner Publishing, it does everything yours does and more, plus it operates just like a Macintosh! A desktop, pull down menus, multiple windows, dialog boxes, and it even has its own clock. Everything I need is on the screen and the mouse does it all. Use it at home and at the office, and the kids are using it too.

Available At Dealers Now.
Suggested Retail: \$125.00
Ask your dealer for a MouseWrite demonstration, or send \$3.00 to Roger Wagner Publishing for your own MouseWrite Demo diskette.

Roger Wagner
PUBLISHING, INC.

10761 Woodside Avenue • Suite E • P.O. Box 582 • Santee, CA 92071 • 619 562-3670

the move from the pattern matching the game board. It then rotates the move to match the game board, and reflects it if mirror=true. It also updates the array history to record the pattern used and the row and column chosen.

Match

Returns a Boolean value (true/not true) to indicate if the game board matches the position being examined. If it does, the function also returns values for rotate (how many times the pattern must be rotated 90 degrees to the right to match the game board) and mirror (if the pattern has to be reflected to get a match).

Matchbox Gaming

Around 1960, a scientist named Donald Michie developed a "machine" that played tic-tac-toe. It began as a completely ignorant player, then learned from experience until it became a competent opponent. Called MENACE (Matchbox Educable Naughts And Crosses Engine), this machine stored its experiences in 300 matchboxes containing colored beads with various tic-tac-toe positions drawn on the outside.

Each matchbox represented a different pattern MENACE was likely to encounter. To reduce the number of possible patterns, Michie restricted the games to ones in which MENACE played first. Thus, MENACE made the first, third, fifth, seventh, and ninth moves of the game. The pattern for the first move was just a blank playing field, and no matchboxes were necessary for the ninth move, because MENACE simply played the last empty position.

Each matchbox had a color assigned to every possible move. The number of beads of a given color in the matchbox represented the value of that color's move in the game. Initially, each move for a pattern had the same number of beads assigned to it—three of each color represented the value of the third move, two of each color the fifth move, and one of

inCider

each color the seventh move.

Michie generated a move for MENACE by selecting the matchbox for the current position, shaking it, then randomly drawing a bead from the matchbox. The color of the bead determined the move MENACE chose. At the end of each game, Michie examined the matchboxes used in that game. If MENACE lost the game, Michie discarded the bead drawn

from the box. For a drawn game, he returned the bead to the box and added an extra bead of the same color. And if MENACE won the game, Michie not only returned the bead, he also added three more of the same color. Thus, after being used several times, a matchbox held beads for the winning moves or draws, while beads that led to losses were discarded. □ —R.A.D.

T·H·E HANDLERS

VALUE • POWER • SOPHISTICATION • SIMPLICITY

- The Handlers is a software package of three programs; word processing, file management and a spell checker for the Apple II, II+, IIe and IIc.
- The Handlers is *the* answer to programs that cost a lot, take a lifetime to learn and then don't deliver!
- The Handlers delivers the power and sophistication of large scale mainframe systems.
- The Handlers makes immediate sense to the beginner and the experienced computer user.
- More and more people are selecting the Handlers over Appleworks. *Why?* Because the Handlers beats Appleworks for power, ease of use and price! We took the difficulty out of the program when we engineered it so you get what you want out of the Handlers without wasting time.

WORD HANDLER

This best selling WP is surprisingly powerful and yet easy to use.

- Global search & replace
- Block moves
- 40, 66 & 80 column
- Form generator
- Easy to remember mnemonic commands
- Unlimited tabs
- Bold, underline, superscript, justification
- What you see on screen is what you get

LIST HANDLER

A truly fast & efficient file management program.

- Over 3,000 records per disk
- Up to 200 characters per field and 255 fields per record
- Unlimited sorting fields
- Sorts alpha, numeric and date sorts
- Merges with word processors, create form letters
- Sorts 3,000 records in under 45 seconds

SPELL HANDLER

The spell checker that works hand in glove with the Word Handler.

- 90,000 words on one diskette
- Add up to 2,000 of your own words
- No disk swapping
- Scans 10 words per second
- Word count
- If you knew what we know about our products, you'd be our next customer!

Circle 23 on Reader Service Card.

Advanced Logic **als** Systems, Inc.

1195 E. Arques Avenue • Sunnyvale, CA 94086 • 408/730-0307

BUY HARDWARE AND SOFTWARE AT WHOLESALE + 8% AND GET 14-30 DAY SOFTWARE RENTALS†..

Every few months, *The NETWORK* saves its members more than \$24,000 and processes over 100,000 orders.

The nation's largest corporations depend on PC NETWORK!

On our corporate roster are some of the nation's largest financial industrial and professional concerns including some of the most important names in the computer industry:

AT&T	General Motors
Barclays Bank	Gillette
Bell & Howell	Hewlett Packard
Citibank	Hughes Aircraft
Columbia University	IBM
Data General	ITT
Exxon	Kodak
Farm Bureau Insurance	Multimate
Frontier Airlines	United Nations
General Mills	Yale University
General Electric	Veteran's Administration

plus thousands of satisfied consulting firms, small businesses, user groups, municipalities, government agencies and value-wise individuals ACROSS THE NATION! Their buyers know that purchasing or renting from PC NETWORK saves them time, money and trouble. They also count on us for product evaluation, professional consultation and the broadest spectrum of products and brands around.

CALL TOLL FREE 1-800-621-S-A-V-E

In Illinois call (312) 280-0002
Your Membership Validation Number: **18X5**

You can validate your membership number and, if you wish, place your first money-saving order over the phone by using your VISA, MASTERCARD or AMERICAN EXPRESS. Our knowledgeable service consultants are on duty Mon-Fri 8 AM to 7 PM, SAT 9 AM to 5 PM CST.



PERSONAL COMPUTER NETWORK
320 West Ohio
Chicago, Illinois 60610

Call now . . . Join the PC NETWORK and start saving today!



PC NETWORK • MEMBERSHIP APPLICATION

YES! Please enroll me as a member in the PC NETWORK™ and rush my catalog featuring thousands of computer products, all at just 8% above DEALER WHOLESALE PRICES. I will also periodically receive "THE PRINTOUT", a special up-date on merchandise at prices BELOW even those in my wholesale catalog, and all the other exclusive, money-saving services available to Members.

8X5

I am under no obligation to buy anything. My complete satisfaction is guaranteed. Please check (✓) all boxes that apply:

- | | |
|---|--|
| <input type="checkbox"/> Basic Membership
With 14 Days Rental | <input type="checkbox"/> Special V.I.P. Membership*
With 30 Days Rental. |
| <input type="checkbox"/> One-year membership for \$8 | <input type="checkbox"/> One-year membership for \$15 |
| <input type="checkbox"/> Two-year membership for \$15 (SAVE \$1) | <input type="checkbox"/> Two-year membership for \$25 (SAVE \$5) |
| <input type="checkbox"/> Business Software Rental Library for \$25 add'l. per year—with 14 day rentals | <input type="checkbox"/> BOTH Business and Game Software Rental Libraries for \$30 add'l. per year—with 30 day rentals |
| <input type="checkbox"/> Games Software Rental Library for \$10 add'l. per year | *VIP members receive advance notice on limited quantity merchandise specials |
| <input type="checkbox"/> Bill my credit card: <input type="checkbox"/> VISA <input type="checkbox"/> MasterCard <input type="checkbox"/> American Express | |

Account Number:

Exp. Date _____
mo. year

Check or money order enclosed for \$ _____

Name _____

Address _____ Apt. No. _____

City _____ State _____ Zip _____

Telephone () _____

Please provide the following information to insure compatibility with your system (check all boxes that apply):

- | | | | |
|---------------------------------------|------------------------------------|------------------------------------|---------------------------------|
| <input type="checkbox"/> APPLE //e | <input type="checkbox"/> APPLE //c | <input type="checkbox"/> APPLE //+ | <input type="checkbox"/> IBM-AT |
| <input type="checkbox"/> MACINTOSH | <input type="checkbox"/> LISA | <input type="checkbox"/> APPLE III | <input type="checkbox"/> IBM PC |
| <input type="checkbox"/> Other: _____ | | | |

Signature _____
(Signature required to validate membership)

Copyright © 1985, PC NETWORK INC.

IBM PC HARD DISK SYSTEM



IBM PC w/256K
Floppy Drive Controller
1 Double Sided Double
Density Disk Drive
Half Height 10MB
Disk Subsystem

CALL FOR
LATEST IBM
ANNOUNCEMENTS

CUSTOM
CONFIGURATIONS
WELCOME

\$1,749.00*

MACINTOSH SYSTEMS

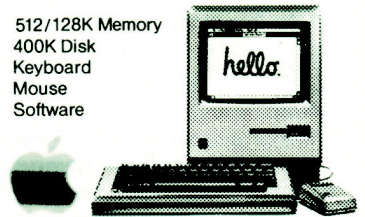

512/128K Memory
400K Disk
Keyboard
Mouse
Software

Price Too Low Too Print!!!

PC NETWORK

Apple IIc External
Disk Drive

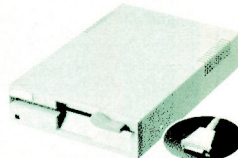

\$95.00*



APPLE 15" WIDE
IMAGEWRITER
with Accessory Kit

\$485.00*

3000 / MODEM IIe

Fully Micromodem IIe Compatible
includes \$200 worth of FREE connect
time on Dow Jones & News Net

\$90.00*

MONOGRAM

DOLLARS AND SENSE™
for Apple II+e

\$31.00*

BRAND NAME DISKETTES *Guaranteed for Life!* (Quality Discounts Available)

SS/DD For Apple II & III Box of 10	\$7.95*
DS/DD Box of 10	8.95*
MACINTOSH Box of 10 Includes free Flip & File Case	21.95*

BULK DISK SPECIAL *Guaranteed for Life!*

DS/DD	Each .79*
SS/DD	Each .69*
Packaged in 50 Includes Sleeves & Labels	

Apple *Appleworks* **\$165.00***

Central Point *Copy II + Copy II MAC*
Back-up Protected Software **20.00***

GTE SYLVANIA *1700 Watt*
Filtered Surge Protector **29.95***

EPSON® PRINTERS *Unbelievable Low Prices!!!*

**NEW MODELS
NOW AVAILABLE!!**

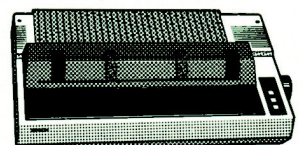

LX-80	80COL/1000CPS	\$199.00*
FX-85	85COL/160CPS	299.00*
FX-185	185COL/160CPS	429.00*

Wholesale Prices Change Rapidly... If you ever see a lower price advertised anywhere please call! You will find the Network's Price will always be the best!



THE SPIRIT OF **ADV**

*Decorate your own
dungeon, drag in
your own dragons,
and dodge your
own dangers
by creating your own
adventure game.*



ENTURE

by James L. Muller

You may enjoy commercial adventure games, but haven't found one with all the special features you'd like. Then why not write your own? You'll achieve a sense of accomplishment as you exercise your creativity and develop your programming skills.

I'll present the major concepts behind adventure-game programming to enable you to write a game. Although my ideas won't represent an exhaustive study of the subject, they will provide a good starting point for those who already have a moderate knowledge of Applesoft BASIC. (The concepts apply equally well to Pascal.)

You should write a generalized program with as much reusable code as possible, so you can create new games simply by initializing the variables differently. Before you write the actual code, though, you should design the program focusing on the details—identifying rooms, handling movement, interpreting commands, and so on—rather than on the overall structure to control the program.

Room Identification

The most fundamental concept in adventure games is a set of "rooms," which need not necessarily imply different physical locations: Two rooms can represent the same location, with a change having been made in one of them. (I'll discuss this in more detail later.)

Many beginners use different sections of code to represent various rooms (for example, lines 100–190 for the entrance, lines 200–290 for the next room, and

so on), and each section uses a set of IF (or ON X GOTO) statements to control movement. With this method, you must retype the same statements for each room (changing only the GOTO destinations). This wastes memory and severely limits the input vocabulary the game recognizes. A better way to program this is to use a single, simple instruction loop that lets various sections of code represent different possible actions according to player input, rather than the actual rooms.

Number rooms sequentially, beginning with one (for internal identification only, since the player never sees the numbers). The rooms need not connect sequentially. Next, store this information in an integer variable, RM%. (See the accompanying **Table** for a description of the variables described in this article.)

You can put all other room properties, such as names and descriptions, into arrays NM\$() and DE\$(), respectively. Then, by using the room-number variable as a subscript (the value within the parentheses), you can obtain the properties of the current room. For example, if you want the name of the current room printed after every move, end your instruction loop with the statement:

```
PRINT "YOU ARE IN THE ";  
  NM$(RM%); " ROOM."
```

If your game has more than 11 rooms, you must declare these arrays explicitly—DIM NM\$(50) for 50 rooms, for example—since Applesoft automatically dimensions undeclared arrays to a range of zero to ten.

Movement

When a player types in a command to move in a certain direction, the command interpreter (called a *parser*) calls a subroutine (**Listing 1**) to handle this movement. (All listings are on page 110.) As the player moves from one room to another, this subroutine changes the value of RM%. (Later, I'll describe in more detail how the parser works.)

The player's destination—the new value of RM%—depends on the direction in which he or she wants to move, the variable stored in the string OJ\$, and his or her present location, the current value of RM%. (The variable named OJ\$ stands for object. This choice of name will make more sense when you look at the parser.) Thus, you should declare a two-dimensional array, the "next-room" array—DIM NR%(4,50), for example. The values in the NR% array are the destination-room numbers. The first index represents the direction code, D%—0, 1, 2, 3, and 4 for no passage, north, south, east, and west, respectively—and the second, the current-room number.

The value of OJ\$ determines the value D% will be, as the following code exemplifies:

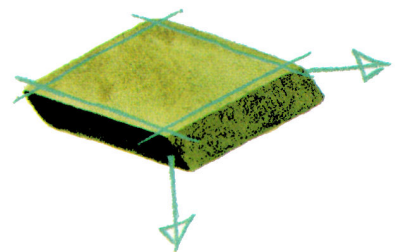

Table. Variable descriptions.

Variable	Type	Description
RM%	Integer	Current room number
OJ\$	String	Object (returned by parser)
NM\$(RM\$)	Array	Room name
DE\$(RM\$)	Array	Room description
NR%(D%,RM%)	Array	New-room value
D%	Integer	Direction code (1-4)
LR%	Integer	Previous room
OB\$(n)	Array	Object name
OL%(n)	Array	Object location
CO\$	String	Input command string
VB\$	String	Desired action

n is the number of rooms and objects you choose.

```
OJ$ = LEFT$(OJ$,1): IF OJ$ = "N"
THEN D% = 1: IF OJ$ = "S"
THEN D% = 2: IF OJ$ = "E"
THEN D% = 3: IF OJ$ = "W"
THEN D% = 4
```

Then, assuming NR%(D%,RM%) doesn't equal zero, the code for the location of the new room is: RM% = NR%(D%,RM%)

The LEFT\$ function above truncates (cuts off) all characters after the first, so the computer understands any direction that begins with N to be NORTH. You can test for NORTH as well as N if you prefer.

The program should check that a move is "legal" (Does a passageway exist in that direction? Does a locked gate prevent entrance?) and you should insert the appropriate lines using IF...THEN statements just before the final statement that assigns the new-room value.

Special values in the NR% array can trigger special actions—zero for "no passage," for example. A value greater than 1000 can indicate an obstacle, making the program branch to an obstacle-handling subroutine (see **Listing 2**). Inside this subroutine, values from 1001-1050 can represent a locked gate; when a player unlocks the gate, 1000 is subtracted from that value and the result shows where the passage leads. Similarly, values from 2001-2050 can indicate a magic spell; and values 3001-3050, some other obstacle. This is one place where nonreusable code might make programming easier.

Another variable, LR%, remembers the number of the room just left. You should assign the value of LR% with LR% = RM% after the obstacle check approves the move to the new room, but before the value of RM% changes. So, if the player supplies the appropriate command to return to the room he or she just left (BACK, for example), the program checks that at least one passage leads to that room (simply searches the four directions), then moves in that direction.

An Example

Suppose a player is in room 20, from which N, S, E, and W lead to rooms 15, 4, 10, and no-

FIND OUT ABOUT IT!

Financial Software from Core Concepts™

WORK FORCE II™ 6 programs on 1 disk.

- 1. THE LOAN ANALYZER:** Compute loan and mortgage amortizations, balloon payments, total interest paid, daily percentage rates, present value of capital leases, and periodic payment amounts. Find an unknown term or the amount which can be financed. Print or display amortizations starting or stopping at any period. Currently used by Banks, CPA's and realstate agents across the country.
- 2. THE SAVINGS ANALYZER:** Compute the future value of savings, IRA's, and investments in moments with The Savings Analyzer.
- 3. THE BALANCING ACT™:** Checkbook balancing is made easy with this once a month checkbook balancing program. Menus allow entries to be added or changed. Group totals, amount of error, and all entries can be printed or displayed.
- 4. THE LINE WRITER™:** A line-at-a-time correctable typewriter. Great for addressing envelopes and other small word processing jobs.
- 5. THE WAGE ANALYZER:** Analyze your income by the hour, time & 1/2, weekly, bi-weekly, semi-monthly and annually. Calculate increases or decreases by amount or percent. Printout provides a great way to present pay raises to employees.
- 6. THE CALCULATOR:** Turns your Apple into a four function printing calculator.

"What exactly do you get for this price in these days of \$100 minimum work programs? You get a real value. I found the programs a joy of ease, completely understandable and with a price that's hard to resist. A valuable indispensable tool..." The San Francisco Independent / Business Section / July 4th, 1984.

PROFIT PURSUIT™ 4 programs on 1 disk.

- 1. DEPRECIATION +:** Print or display Straight-Line, Declining Balance, Sum-of-the-Years-Digits depreciations. Plus 3, 5, and 10 year ACRS for personal property, 15 & 18 year ACRS for real estate.
- 2. APR!:** Find the Actual Percentage Rate of loans with prepaid points and fees.
- 3. LEASE MASTER™:** Find lease payment amounts, pre-tax monthly and yearly yield, total yield. Compute with multiple advance payments and residual value. Print or display lease amortizations starting or stopping at any period.
- 4. PRICING MASTER™:** Find the cost, selling price, mark-up, and margin. Recalculate by changing any entry. Print item name and data. A must for retailers & wholesalers!

Compatible with the Apple IIc, IIe, II+ & II. IBM PC, XT, AT, jr

- Rush me WORK FORCE II for the APPLE at \$39.95
 - Rush me PROFIT PURSUIT for the APPLE at \$39.95
 - Rush me WORK FORCE II for the IBM at \$47.95 (prices include shipping)
- Arizona residents add 6% Sales Tax. Overseas's add \$5.00

Card # _____
 Signature _____ Valid From _____ to _____
 Name _____ Phone _____
 Address _____
 City/State/Zip _____



Core Concepts

P.O. Box 24157 Tempe, AZ 85282

AZ residents & inquiries call (602) 968-3756



Call Toll Free

ORDERS ONLY

1-800-525-CORE

30 DAY
 MONEY-BACK
 GUARANTEE

ORDERS SHIPPED
 IMMEDIATELY!

Apple is a registered trademark of Apple Computer. IBM is a registered trademark of International Business Machines.

Finally, an end to the wait for low-cost memory

What You Get	Price	Product	Compatibility
256K plus 80 columns 64K plus 80 columns*	\$199 \$ 99	ADD-RAM 80/256™ ADD-RAM 80/64™	Apple IIe® Apple IIe
16K 80 column screen	\$ 99 \$179	ADD-RAM™ SMARTERM II™	Apple II, II Plus® Apple II, II Plus, IIe®

*can be upgraded to 256K

► ADD-RAM 80/256 and ADD-RAM 80/64 Advanced Memory Boards

Until now if you wanted more speed and memory you had to buy another disk drive. Or another computer. Or you could just wait patiently as the disk drive hummed and the red light glowed.

Now, you can get speed and 64K or 256K additional memory by just slipping an ADD-RAM memory board from Advanced Logic Systems into your Apple IIe. Simply back-up your programs onto the ADD-RAM board for faster access to files and applications. And still retain 80 column screen width.

► ADD-RAM and SMARTERM II: Rounding Out the Family

To upgrade your Apple II or Apple II Plus from 48K to 64K, take advantage of the original ADD-RAM. Or if memory is adequate, upgrade to 80 columns with SMARTERM II for your Apple II, II Plus or IIe.

Visit your Apple Dealer today to see ADD-RAM and SMARTERM II in action. Or contact us directly.

If you knew what we know about our products, you'd be our next customer.

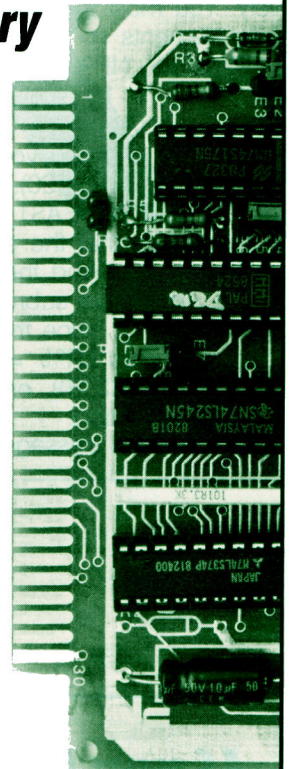

Apple, Apple IIe, Apple II, Apple II Plus are registered trademarks of Apple Computer, Inc.

ADD-RAM 80/256, ADD-RAM 80/64, ADD-RAM and SMARTERM II are trademarks of Advanced Logic Systems, Inc.



Advanced Logic Systems, Inc. 1195 E. Arques Ave., Sunnyvale, CA 94086. (408) 730-0307

Circle 61 on Reader Service Card.

PRINCE — Make color prints with your black & white printer

Prince

Color Prints from your black and white printer.



For Apple II+, IIe, IIc Computers

BAUDVILLE 

- Produce up to 80 colorful printouts for greeting cards, announcements, stationery, labels, stickers, t-shirt transfers and much more.
- Contains PRINCE software, 4 color ribbons, a library of art and text styles, and Craft Kit with paper selection, envelopes, and sticker/label stock.
- Edit and print pictures from popular graphics programs including Blazing Paddles®, Dazzle Draw®, Micro Illustrator®, Pixit® and more. Any screen image can be printed including double hi-res.
- For Apple® II+, IIe and IIc Computers:
- Printers Supported: Epson MX-80, FX-80, RX-80, Imagewriter, DMP, C.Itoh 8510/Prowriter, 8510SC, NEC 8023

SEE YOUR DEALER or for direct orders, enclose \$69.95 (plus \$3.50 for shipping/handling) and specify printer model.

VISA or Mastercard orders, call:
ORDERLINE 800-824-8873
(In Michigan, 616-957-3036)

BAUDVILLE
1001 Medical Park Dr. SE
Grand Rapids, MI 49506

Software and printer trademarks acknowledged.

where (a wall, perhaps), respectively. You must initialize these array elements so that $NR\%(1,20) = 15$, $NR\%(2,20) = 4$, $NR\%(3,20) = 10$, and $NR\%(4,20) = 0$. (Applesoft initializes all variables to zero, so you don't have to set $NR\%(4,20)$.) At the command MOVE EAST, the parser determines that the action desired is a move and the direction is east. The move subroutine sets $D\% = 3$, and, since there is no obstacle, it sets $LR\% = 20$ and $RM\% = NR\%(3,20)$, or 10—the new room location.

If you want a passage to open

up after a player says a magic word, or if another room property changes due to an action other than movement, you could treat the room as two separate rooms—but they must appear similar to the player. The appropriate subroutine must change $RM\%$ when the conditions are fulfilled. In most cases, however, it's just as easy to have the nonmove subroutine change the pertinent room property, thus making the two similar rooms unnecessary. Either way, it will probably be easier to program room-dependent,

nonmove actions with nonreusable code.

Tips

The only actual work involved is initializing suitable values for the $NR\%$ array. You should map out the set of rooms and all the passages carefully to make sure a player can enter and exit each one. The main objective shouldn't be in an inaccessible room! Listing the $NR\%$ array in columns, with direction across the top and room number increasing down the side makes programming more convenient. Then, when you eventually write the program, you have complete freedom over where each passage leads: Going west from room A to room B doesn't require that going east gets you back again, or even that a return route exists. You should make most passages reversible, though, so the player doesn't become frustrated by being unable to explore or second-guess his or her decisions.

I limited this game to 50 rooms and four directions, but the only real limitation is computer memory. Including up and down would make the $NR\%$ array 50 percent larger. If your game needs many rooms and memory is a problem, defining only half the rooms is one solution. Then reinitializing the pertinent variables at a critical point can make the second set of rooms available. The biggest demand on memory will probably be the string variables holding the room descriptions, so reducing the number of rooms accessible at a time will do the most to save memory.

Managing Objects

Objects in adventure games usually contribute to the score and frequently affect the player's options. (Note: This is not the same "object" used in the move subroutine.) First assign each object (I used 20) an identification number—again for internal identification only. Then, define two arrays— $DIM\ OB\$(20)$ and $DIM\ OL\%(20)$ —to hold the object names and locations, respectively.

Special values for $OL\%$ or for the $OL\%$ array can represent specific conditions, such as zero for a nonexistent object or 100 for an

If you live in our Solar System, you CAN find the Comet!

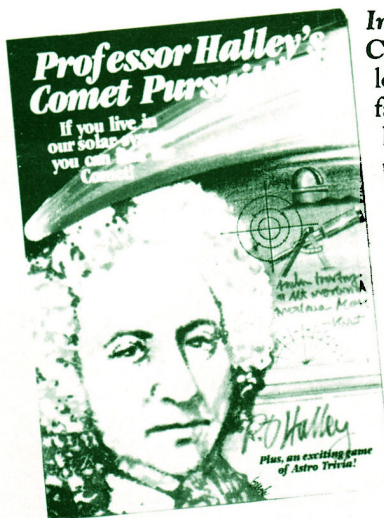

Introducing Professor Halley's Comet Pursuit! Take a computerized look into the night's sky at the famous Halley's Comet! YOU can become a Comet Champion by using *Skyviews* to find Halley's Comet and *Comet Challenge* to launch your personal fly-by to the Comet. It's an exciting astronomy game that'll leave you trailing with excitement!



1660 Hotel Circle No./Ste. 310/San Diego, CA 92108/(619) 296-8555

AVAILABLE AT:

B. Dalton Booksellers

Circle 136 on Reader Service Card.

640K

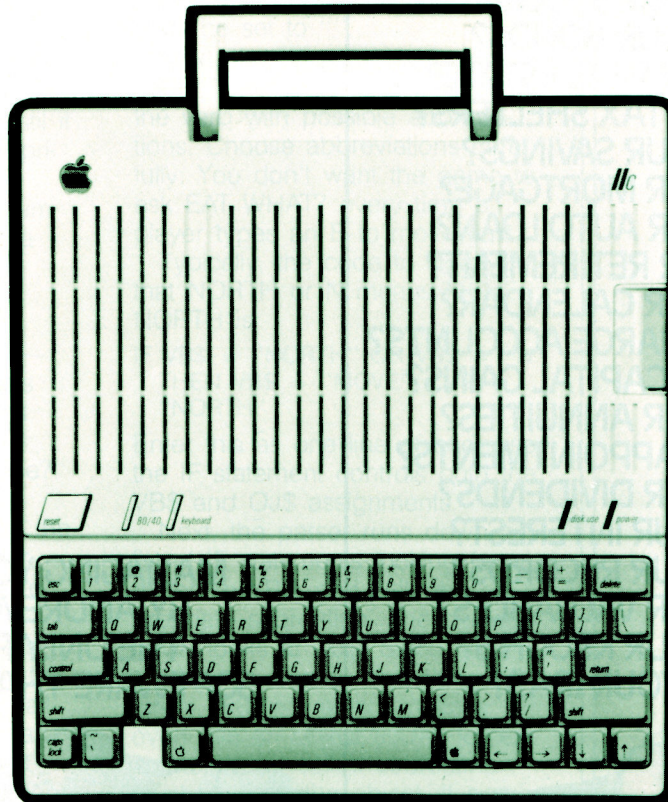

Fatter than a Fat Mac and ready for serious business — that's an Apple //c with a MultiRam™ C Card installed. MultiRam adds from 256K to 512K to your //c's own 128K memory to give you up to a 640K //c.

With a 640K Apple //c you can...

- Run AppleWorks with a 413K Desktop. That's a Desktop large enough for the most demanding business or personal use. Data bases and spreadsheets can grow beyond the frustrating limitations of the old 55K Desktop.

You can even eliminate AppleWork's need for an external disk drive and speed up AppleWorks by loading all the program disk into MultiRam's memory.

- Run the new SuperCalc3[®], an integrated spreadsheet for your //c with the power of Lotus 1-2-3, and create complex models up to 512K in size.
- Run FlashCalc, Magic Office, MagicCalc and future programs that will use most or all of MultiRam's memory.

- Use MultiRam C's memory as a RAM disk for ProDOS and DOS equaling up to four standard //c disk drives with speeds more than 20 times normal.

The MultiRam C Card...

- Easily installs inside the //c using only a screwdriver. No messy soldering or jumpers are required. MultiRam's expandable memory is easily increased if you choose a 256K version.
- Includes a comprehensive manual, AppleWorks memory expansion software, ProDOS and DOS RAM disk software, and RAM test software at no additional charge.
- Features a full 5-year warranty and is 100% compatible with all //c hardware and software. MultiRam uses a low 1.2 watts of power with its CMOS power saving design. CMOS insures longer sessions when using a battery pack with your //c.

MultiRam C 256K — **\$329.95**
512K — **\$429.95**

Ask for MultiRam™ C at your favorite dealer today.

Apple is the registered trademark of Apple Computer, Inc. AppleWorks and Macintosh are trademarks of Apple Computer, Inc. FlashCalc is the trademark of Paladin Software Corporation. Lotus 1-2-3 is the trademark of Lotus Development Corporation. Magic Office and MagicCalc are trademarks of Artsci, Inc. SuperCalc3[®] is the trademark of Sorcim/IUS, Inc.



Checkmate Technology, Inc.

509 South Rockford Drive • Tempe, Arizona 85281-3021
(602) 966-5802 U.S.A. Telex: 165-025 CEC PHX

MANAGING YOUR CHECKBOOK?
 MANAGING YOUR BUDGET?
 MANAGING YOUR BILLS?
 MANAGING YOUR CASH FLOW?
 MANAGING YOUR TAXES?
 MANAGING YOUR INSURANCE?
 MANAGING YOUR STOCKS?
 MANAGING YOUR BONDS?
 MANAGING YOUR REAL ESTATE?
 MANAGING YOUR TAX SHELTERS?
 MANAGING YOUR SAVINGS?
 MANAGING YOUR MORTGAGE?
 MANAGING YOUR AUTO LOAN?
 MANAGING YOUR RETIREMENT?
 MANAGING YOUR CALENDAR?
 MANAGING YOUR CHARGE ACCOUNTS?
 MANAGING YOUR CAPITAL GAINS?
 MANAGING YOUR ANNUITIES?
 MANAGING YOUR APPOINTMENTS?
 MANAGING YOUR DIVIDENDS?
 MANAGING YOUR INTEREST?
 MANAGING YOUR RECORDS?
 MANAGING YOUR VALUABLES?
 MANAGING YOUR KEOGH'S?
 MANAGING YOUR IRA'S?

MANAGING YOUR MONEY*
 BY ANDREW TOBIAS.
 THE ONLY FINANCIAL
 SOFTWARE THAT DOES IT ALL.

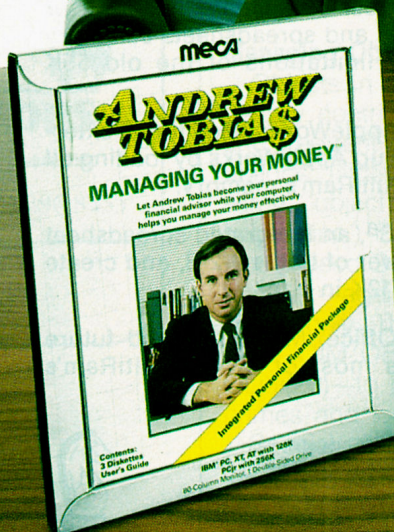

Software that
 makes your
 personal computer
 worth having.

meca®

object in a player's possession. When a player wants to list his or her possessions, the appropriate subroutine searches the list of objects and prints the name of any whose location is 100. An inventory subroutine could be:

```
PRINT "YOU ARE CURRENTLY
HOLDING:": FOR I = 1 TO 20:
IF OL%(20) = 100 THEN PRINT
OB$(I): NEXT I
```

When a player wants to pick up an item, the appropriate subroutine searches the object list until it finds one with both the appropriate name and room, then changes that object's room number to 100. **Listing 3** shows a drop subroutine.

The Parser

What effect does the parser—that subroutine which interprets natural-language, multiple-word commands for the computer—have on the playing experience? Why use text input, anyway? Words are wonderful hooks to the imagination; they provide color, depth, and texture to adventure games.

The parser converts a player's commands into operations on the game's variables, usually by calling a different subroutine to handle each possible operation the game can perform. Its vocabulary generally includes more words than the number of subroutines. You must choose words that fit the style of the game—you don't use force-fields in a magic forest or magic spells in space combat—and those a player is likely to use. Since he or she must use a word the parser recognizes, the program should include an on-line help screen that lists many or all of the usable words.

The parser in **Listing 4** recognizes two-word commands—a verb and an object, even if the second word is not an object grammatically. When a player types in a command, the computer uses INPUT to read the command into string variable CO\$. The parser then scans CO\$ looking for a blank by using the code:

```
FOR I = 1 TO LEN(CO$): IF
MID$(CO$,I,1) = " " THEN J = I:
NEXT I
```

It considers everything before the blank a verb and everything after it an object. The LEFT\$ and RIGHT\$ functions, along with the value of J found, transfer the verb and object into string variables VB\$ and OJ\$ (the OJ\$ used in the move subroutine). If the first blank occurs at the end of the string or if there is no blank, OJ\$ must be set to "".

Next, the parser runs through a set of IF statements to compare the verb with possible abbreviations. Choose abbreviations carefully: You don't want the game to ask EAT WHAT? every time a player types an E to move east.

Typically, the code to signify that NORTH or N means MOVE NORTH is:

```
IF VB$ = "NORTH" OR VB$ = "N"
THEN VB$ = "MOVE": OJ$ =
"NORTH"
```

Enter this as one line of code, so the IF statement controls both the VB\$ and OJ\$ assignments.

Next, the parser runs down a list of IF statements looking for a match to VB\$, and calls the appropriate subroutine. The parser never looks at OJ\$. Since each action may expect something different, and not all subroutines even use an object (RUN, for example), each called subroutine must interpret the object. If a subroutine requires an object (such as DROP SHOVEL) and OJ\$ is empty, the program can call another subroutine that asks for the object, such as:

```
PRINT VB$;" WHAT OR WHERE?":
INPUT OJ$: RETURN
```

The move subroutine (**Listing 1**) and the drop subroutine (**Listing 3**) are examples of the use of OJ\$.

It isn't too difficult to write a parser that will recognize four words. As with most programming, improving the parser comes from thinking about the subject matter (in this case, English) rather than the programming language. First, consider how a player might phrase any command. Then, write a program that separates the input string into its component words.

The trick to interpreting the words rests with the possible actions. Except in the case of ab-

**MANAGING
YOUR MONEY®
IS NOW
AVAILABLE ON
APPLE
Ile AND Iic.**

Coming
October 15th.



APPLE IIe, Iic (128K, 80-Column Monitor, Two Drives)

RAM SLICER

Software

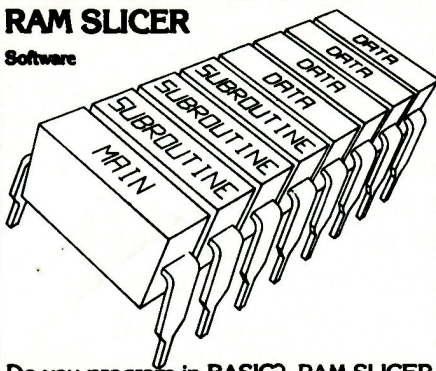

Do you program in BASIC? RAM SLICER offers this unique combination of features.

- Create subroutines whose variables are independent of the calling program except those passed by a variable list.
- Bring subroutines into RAM memory from disk, on an "as required basis".
- Move between programs (subroutines) held simultaneously in RAM memory.
- Store data separate from the program area so it can be accessed from different subroutines.
- Use auxiliary memory in the IIc or extended-memory IIc for data storage.
- Store and recall programs or data using super fast disk capability, e.g., store 28,672 bytes in as little as 5.5 seconds.
- Use powerful data input capabilities in your program and format your output with print formatting capability.

Using the ampersand symbol RAM SLICER adds 35 new commands to BASIC.

Requires Apple II+, Apple IIc or Apple IIe* with Applesoft and Monitor firmware, at least 64K, and at least one disk drive.

PRICE
\$79.95

Includes program disk, over 100 page reference manual, and a disk containing demonstration programs.

Includes Shipping

Money orders and cashiers check orders will be processed right away; allow time for personal checks to clear.

*Apple II+, Apple IIc, and Apple IIe are Registered Trademarks of Apple Computer, Inc.

KWH Technology • (313) 474-6864
P.O. Box 95 • Farmington, MI 48024

Circle 36 on Reader Service Card.

BOWL-KEEPER II

- outgrowth of BOWL-KEEPER
- widely requested features
- complete record keeping for the league secretary
- team and individual records
- many time-saving sorts
- 100 bowler capacity
- full edit capability

for Apple* II+, IIc, IIe, //c
48K, 1 disk drive
printer recommended

\$49.95 (add \$3.00 s/h)

(Fl residents add sales tax)

Send check or money order to:

**CLAYTON &
ASSOCIATES, INC.**

P.O. BOX 6361

Clearwater, Florida 33518

COD (813) 797-7815

*Apple is a trademark of Apple Computer, Inc.

Circle 103 on Reader Service Card.

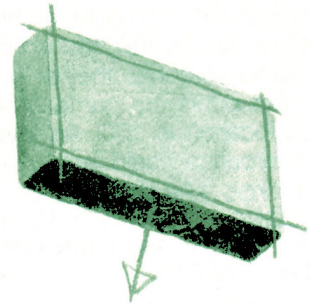

abbreviations (N, S, E, W), the first word will probably be the verb that determines what subroutine is called and the second word will be an object, as mentioned earlier. For most possible actions, the third word will be a preposition, and the last one another object—THROW SPEAR AT DRAGON, OPEN LOCK WITH KEY, GIVE MONEY TO BARTENDER. As a fail-safe, you can have any input command that neither the parser nor a called subroutine recognizes trigger the output message "Please rephrase and try again."

Final Notes

A control structure (the basic input/command loop) acts as the main program. (Listing 5 is an example.) Initialize the arrays by reading values from a disk file if speed isn't a problem or by putting them into initialization subroutines if memory space isn't a problem. If memory is short, you can put these initialization subroutines into a separate program that chains into the main program.

Finally, you can incorporate many other ideas into your game, such as mazes, which are different every time you play the game (have part of the NR% array be generated randomly according to some rules to guarantee you can reach all parts), or monsters that move from room to room. Use your imagination; come up with a new twist. Your game will be more fun to write, play, and show to others when you know how it works yourself. ■

Listings 1-5 are on p. 110.

Write to James L. Muller at 8
Bates Road East, Watertown, MA
02172.

AT LAST! The right tool for anyone who has ever written, or attempted to write, an Assembly language program.

(For Apple* II, II+, IIe, and E//e)

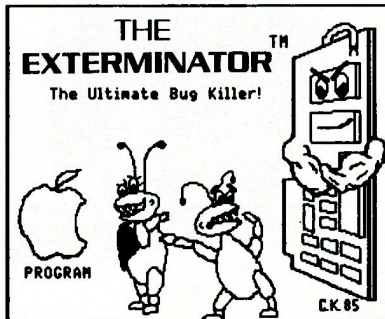

Here are just a few features: Stop the program with one of 85 SOFT BREAKS or when a selected address is referenced: Access to the processor's registers during program execution: Always available when needed: Completely invisible to your programs: Built in Mini-Assembler: Full support of the 6502 and 65C02: Count the clock cycles required to execute sections of code: Regain control of lost programs: Use a printer or terminal for program debugging while viewing graphics on the Apple screen: Single-Step and Trace functions: And the most versatile feature of all; Design your own test which is performed after each instruction of the program being debugged: 6 MONTH WARRANTY: MADE IN U.S.A.: 15 DAY MONEY BACK GUARANTEE ON DIRECT ORDERS: Ask for THE EXTERMINATOR at your favorite retailer or order direct by sending check or M.O. for \$179.95 US (Ohio res. add 6%) to:

Sota Electronics Inc.

P.O. Box 162
LaSalle, MI 48145

Orders from U.S.A., Canada, VI & PR only. Sorry, no COD or credit card orders. For more information call (419) 255-7224. Dealer inquiries welcome.

*Apple is a registered trademark of Apple Computer, Inc.

EXTERMINATOR is a trademark of Sota Electronics, Inc.

Flight Simulator II

For Apple II+,
Apple IIe, & Apple IIc

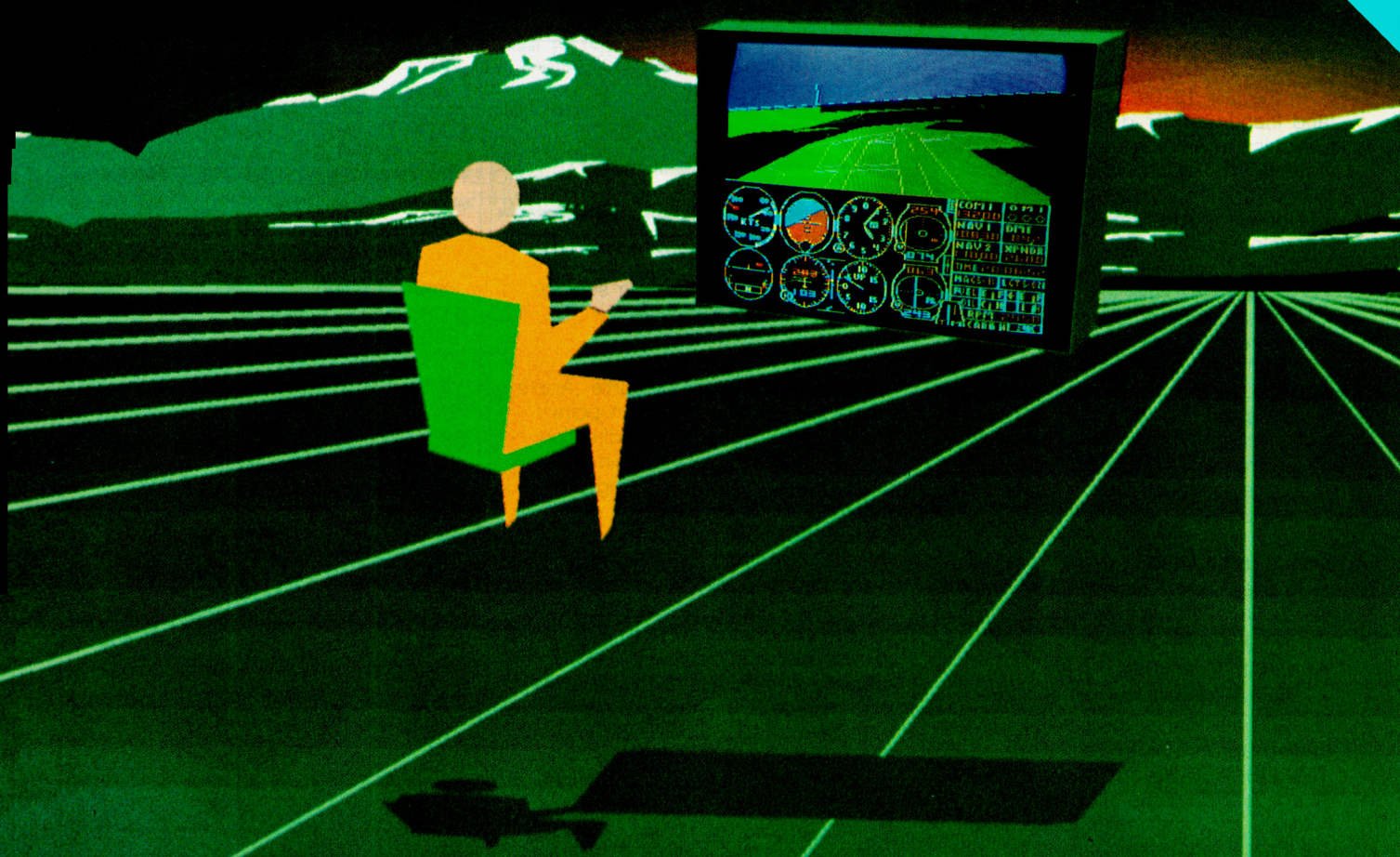

Put yourself in the pilot's seat of a Piper 181 Cherokee Archer for an awe-inspiring flight over realistic scenery from New York to Los Angeles. High speed color-filled 3D graphics will give you a beautiful panoramic view as you practice takeoffs, landings, and aerobatics. Complete documentation will get you airborne quickly even if you've never flown before. When you think you're ready, you can play the World War I Ace aerial battle game. Flight Simulator II features include ■ animated color 3D graphics ■ day, dusk, and night flying modes ■ over 80 airports in four scenery areas: New York, Chicago, Los Angeles, Seattle, with additional scenery areas available ■ user-variable weather, from clear blue skies to grey cloudy conditions ■ complete flight instrumentation ■ VOR, ILS, ADF, and DME radio equipped ■ navigation facilities and course plotting ■ World War I Ace aerial battle game ■ complete information manual and flight handbook.

See your dealer . . .

or write or call for more information. For direct orders enclose \$49.95 plus \$2.00 for shipping and specify UPS or first class mail delivery. American Express, Diner's Club, MasterCard, and Visa accepted.

Order Line: 800 / 637-4983

Circle 156 on Reader Service Card.

subLOGIC
Corporation
713 Edgebrook Drive
Champaign IL 61820
(217) 359-8482 Telex: 206995

Pascal's Turtle

Discover the fun of Apple Pascal's Turtle Graphics.

by Tom Swan

In the late 1970s, Seymour Papert and friends at MIT designed Turtle Graphics to help teach coordinate geometry. The "turtle," a squatty robot with a tail pen you could pull up or put down, moved across a piece of paper on the floor and drew pictures. With this surprisingly simple idea, you could easily express complicated graphics algorithms and create sophisticated designs by using "turtle motions"—positioning the turtle, rotating it to various angles, and sending it across the floor or across a computer screen. This month, I'll examine Apple Pascal's version of Turtle Graphics, and also look at procedures, functions, and loops.

Using Turtle Graphics

To use Apple Pascal's Turtle Graphics routines, add a USES clause to the program declaration:

```
PROGRAM MyDrawings;  
  USES TurtleGraphics;
```

USES tells Pascal to look for the TurtleGraphics unit in the SYSTEM.LIBRARY file on your boot disk. A *unit* is a precompiled collection of routines and other items that extend the Pascal language. Other units in SYSTEM.LIBRARY are AppleStuff, ChainStuff, and Transcend. You can

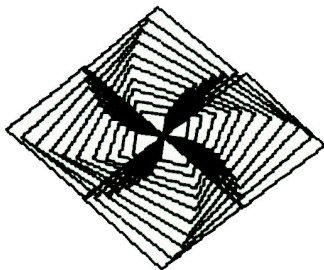

Figure 2. Program Boxes produces intricate designs such as this one using only a few simple Turtle Graphics commands. This pattern was produced with a Step of nine.

Figure 1. Use these color names with the PENCOLOR and FILLSCREEN commands.

NONE	WHITE	BLACK	REVERSE	RADAR
BLACK1	GREEN	VIOLET	WHITE1	BLACK2
ORANGE	BLUE	WHITE2		

also write your own units, a subject I'll cover later in this series.

The Turtle

Unlike Papert's original turtle, Apple Pascal's is invisible. You can point this imaginary turtle in any direction, then send it walking a certain distance. If you select a drawing color beforehand, the turtle leaves a trail—a line on the graphics display—as it moves.

You can also tell the turtle to go directly to a specific location on the screen, designated by a pixel or pel (picture element) coordinate. Apple graphics numbers horizontal pixels from zero to 279 and vertical pixels from zero to 191. Coordinate (0,0) designates the lower-left corner and (279,191) the upper-right corner.

The command InitTurtle turns on the Apple graphics screen, erases it, and positions the turtle in the center of the display facing right. **Tables 1-4** list other TurtleGraphics commands, and **Figure 1** and **Table 5** list a few associated values.

Drawing Boxes

To draw a box, move the turtle a certain distance, turn it 90 degrees, and repeat these steps four times. By specifying only distances and angles, rather than exact pixel coordinates, you can use the same program to draw a box anywhere on the screen. For example, in the following program, the turtle moves 50 pixels in the direction it is currently pointing, turns 90 degrees, and repeats the process until the box is drawn:

```
PenColor( Blue );  
FOR Side := 1 TO 4 DO  
  BEGIN  
    Move( 50 );  
    Turn( 90 );  
  END;
```

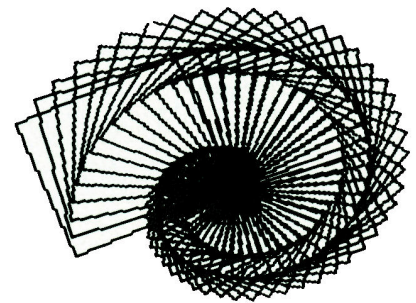

Figure 3. As shown here, Boxes is not limited to one design. A Step of 91 made this drawing.

PenColor selects one of the several drawing colors **Figure 1** lists.

FOR Loops

FOR loops always count by single units (here, integers using variable I), and can count either up:

```
FOR I := 1 TO 10 DO  
  WRITELN( I );
```

or down:

```
FOR I := 10 DOWNTO 1 DO  
  WRITELN( I );
```

As the box example showed, you can surround multiple statements by BEGIN and END. These two key

"We will match any mail order price in this issue."

William F. Gollan
President, BCP

We'll support, service and warranty everything we sell and stand behind it 100%. We won't charge you for shipping or handling, nor will we penalize you for using a credit card.

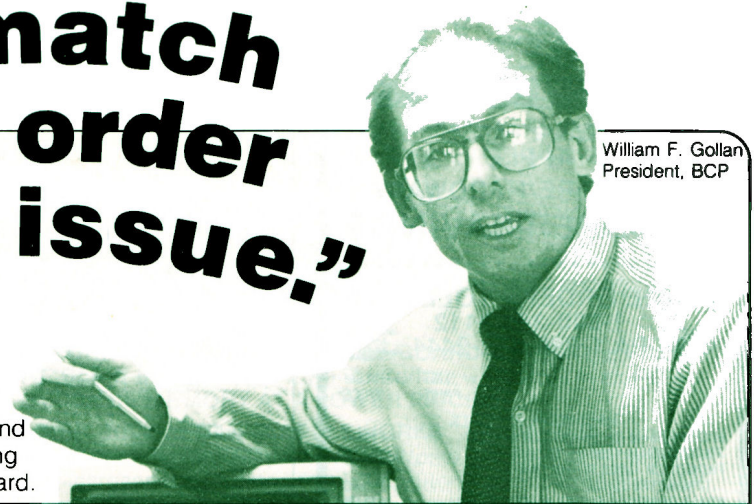

MODEMS

D.C. Hayes			
Smart 300 l/c w/sc & cable	179.95	Prometheus	
Micro Modem l/c w/sc	149.95	Pro 1200	309.95
Smart 1200	384.95	Pro 1200 A w/sc	299.95
Smart Modem 2400	594.95	Zoom	
Transit w/128k	289.95	Zoom Micro l/c + w/sc	159.95

PERIPHERALS & ACCESSORIES

Apple		Printer Stand	19.95
II E's & II C's	CALL	System Saver	64.95
Mac 128k & 512 k	CALL	A-B Box w/cable	74.95
AST		Koala Technologies	
Multi I/O	159.95	Koala Pad	74.95
Curtis		Joysticks	
Diamond	34.95	Kraft	39.95
Emerald	39.95	Hayes Mach III's	39.95
Ruby	59.95	Microsoft	
Disks		Softcard II 6mhz	269.95
Verbatim		Premium Pack l/c	259.95
Bonus SS/DD (10)	12.95	Titan	
Bonus DS/DD (10)	16.95	Accelerator	229.95
Maxell		64k Ram	144.95
MD 1 SS/DD (10)	19.95	128k Ram	164.95
MD 2 DS/DD (10)	26.95	Neptune 64k + 80	189.95
Kensington		Neptune 128k + 80	209.95
Dust Image	9.95	Neptune 192k + 80	239.95

GRAPHIC INTERFACES & BUFFERS

Orange Micro		Hot Link l/c	49.95
Grappler +	84.95	Textprint	
Grappler + w/64k	174.95	Print II	129.95
Grappler + RS-232C	84.95	Thirdware	
Grappler C	CALL	Fingerprint +	99.95

PRINTERS DOT MATRIX

Apple		LO 1500	919.95
Imagewriter 10"	494.95	Okidata	
Imagewriter 15"	564.95	ML 192	364.95
Citizen		ML 192 Image	389.95
MSP 10 160	284.95	ML 193	509.95
MSP 15 160	424.95	ML 84	654.95
MSP 20 200	424.95	Star Micronics	
MSP 25 200	544.95	SG 10	239.95
Epson America		SD 10	579.95
LX 80	239.95	SR 10	499.95
LX 80 F/T	274.95	Toshiba	
FX 85	369.95	P 1340	559.95
FX 185	499.95	P 351	1194.95

ACCOUNTING SOFTWARE

Arrays		Dollars & Cents l/c	74.95
Home Accountant	47.95	Forecast	39.95
BPI Software		Peachtree	
BPI A/R	229.95	Basic to Basics	119.95
BPI G/L	229.95	A/R	64.95
Monogram		G/L	64.95
Dollars & Cents	64.95		

BUSINESS SOFTWARE

Apple		Human Edge	
Appleworks	199.95	Mind Prober	34.95
Applied Soft Tech		Kensington	
Versalform	57.95	Format II	94.95
Broderbund		Living Videotext	
Bank Street Writer	44.95	Think Tank	89.95
Bank Street Speller	44.95	MegaHaus	
Bank Street Filer	44.95	MegaWorks	79.95
CBS		Microsoft	
Stockpac II	94.95	Multiplan	59.95
Creative		Microstuff	
Creative Writer	49.95	Crosstalk	109.95
Creative Filer	62.95	Penguin	
Down Jones		Home Data Mng	CALL
Market Analyzer +	209.95	Home Connection	CALL
Investors Workshop + l/c	89.95	Quark	
Market Microscope	209.95	Catalyst	89.95
Market Mng	149.95	Word Juggler	119.95

BUSINESS SOFTWARE

Sensible Software		PFS Write	74.95
Sensible Speller IV	74.95	PFS File	74.95
Bookends	79.95	PFS Graph	74.95
Graphics Dept	79.95	PFS Report	74.95
Sierra On Line		Sorcim/IUS	
Homeword	44.95	Super IIIA	119.95
Homeword Speller	34.95	Stoneware	
Home Word Filer	44.95	D B Master V 4.0 +	189.95
Software Publishing		United Software	
PFS Best Sellers	154.95	ASCII Express	84.95

UTILITIES & LANGUAGES SOFTWARE

Baudville		Turbo Tool	37.95
Actors & Actions T1	20.95	Turbo Tutorial	25.95
Business T1	34.95	Broderbund	
Blazing Saddles	34.95	Dazzle Draw	37.95
Heroes & Villains T1	20.95	Print Shop	34.95
Pixit	34.95	Print Shop GL	18.95
Shape Lib 1.2,3 (ea)	13.95	Print Shop Retill	13.95
Take 1	37.95	Central Point	
Beagle Brothers		Copy II +	24.95
Alpha Pilot	27.95	Funk	
Apple Mechanic	20.95	Sideways	38.95
Bag	20.95	Microsoft	
Basic	25.95	Basic Compiler	234.95
Graphics	37.95	COBOL-80	399.95
D-Code	27.95	Fortran-80	119.95
Diskquick	20.95	Mindscape	
DOS Boss	17.95	Mister Pixel's	20.95
Double Take	25.95	Cartoon Kit	20.95
Fal Cat	25.95	Paint Set	20.95
Flex Text	20.95	Color Me (Main)	20.95
Frame Up	20.95	Rainbow Brite	7.95
GFLE	32.95	Shirt Tales	7.95
I.O. Silver	20.95	Hugga Bunch	7.95
Pronto DOS	20.95	Trink Tonk	7.95
Slicon Salad	17.95	Penguin Software	
Tip Disk # 1	13.95	Cat Graphics	24.95
Triple Dump	27.95	Graphics Magician	37.95
Typealoes	13.95	Magic Paintbrush	24.95
Utility City	17.95	Terrapin	
Sorland International		LOGO	64.95
Turbo Pascal 3.0	47.95		

EDUCATIONAL & PERSONAL SOFTWARE

Barrons		SAT Math	27.95
Computer SAT	54.95	SAT Verbal	27.95
GMAT	54.95	Hayden	
CBS		Learning Company	
Goren's Bridge	49.95	Addition Magician	24.95
Mastering SAT	64.95	Gertrudes Puzzle	29.95
Websters Word Game	19.95	Gertrudes Secrets	29.95
Success Series	24.95	Juggle's Rainbow	29.95
Davidson Associates		Magic Spells	24.95
Classmate	32.95	Moptown Hotel	27.95
Math Blaster	32.95	Moptown Parade	27.95
Speed Reader II	44.95	Reader Rabbit	27.95
Data Disks A.B.C.D (ea)	13.95	Robot Odyssey	34.95
Spell II	32.95	Rocky's Boot	34.95
Word Attack	32.95	Word Spinner	24.95
Data Grade(s) (ea)	13.95	Meca	
Data Roots & Pref.	13.95	Jim Fix Running	49.95
Data SAT	13.95		

MONTHLY SPECIAL

PRINTER RIBBONS

Six (6) Pack Special

	RETAIL	BCP
* Imagewriter	47.95	20.95
* Epson LX80 & FX 85	47.95	20.95
* Epson FX100 & FX185	54.95	27.95
* Okidata 82, 92, 93	24.95	10.95
* Okidata 192 & 193	70.95	40.95

EDUCATIONAL & PERSONAL SOFTWARE

Mindscape		Perfect Score	49.95
Keyboard Cadet	27.95	Typing Tutor III	34.95
Lusher Profile	27.95	Softsync	
Bank St. Music	34.95	Kid Pro Quo	27.95
Bank St. Story B	27.95	Model Diet	25.95
Quality		Personal Acct	34.95
Bag of Tricks	27.95	Spinnaker	
Beneath Apple DOS	14.95	Story Machine	27.95
Beneath Apple Pro DOS	14.95	Alphabet Zoo	20.95
Random House		Delta Drawing	27.95
Charlie Brown's ABC's	27.95	Kids on Keys	19.95
Snoopy Rescue	27.95	Kindercomp	19.95
Scarborough		Snooper Trooper 1.2 (ea)	24.95
Boston Diet	49.95	In Search of	24.95
Build a Book	27.95	Springboard	
Build Refills 1.2 (ea)	13.95	The Newsroom	34.95
Mastertype	27.95	Virtual Combinatics	
New Improved	27.95	Micro Cookbook	27.95
Figure's & Formulas	19.95	Added Menu's (ea)	9.95
Filer	27.95	Xerox/Weekly Reader	
Writing Wizard	49.95	Sticky Bear	27.95
Run for the \$	27.95	ABC	27.95
Songwriter	27.95	Basket Bounce	27.95
Personal Net W.	49.95	Math	27.95
Screenplay		Numbers	27.95
Ken Houston Black Jk	49.95	Opposites	27.95
Trivia Arcade	27.95	Reading	27.95
		Strapes	27.95

GAME SOFTWARE

Activision		Stephen King Mist	27.95
Alcazar	27.95	James Bond Vixen K.	27.95
Ghostbuster's	27.95	Forbidden Castle	27.95
H.E.R.O.	27.95	Voodoo Island	29.95
Philly	27.95	Racter	29.95
Space Shuttle	27.95	Tink's Adventure	20.95
Mindshadow	27.95	Tonk in Buddy Bots	20.95
Rock N Bolt	27.95	Tuk Goes Town	20.95
Blue Chip		Tinka's Mazes	20.95
Barron	34.95	Tinka's Sub. Fair	20.95
Millionaire	34.95	Origin	
Squire	37.95	Caverns Callisto	24.95
Tycoon	34.95	Ultima III Exodus	37.95
Broderbund		Penguin	
Championship Lode R.	24.95	Pensate	19.95
Choplifter	24.95	Quest	24.95
CBS		Swords Kadash	24.95
Murder by Doz	24.95	Transylvania	24.95
Datsoft		Priority	
Bruce Lee	27.95	Forbidden Quest	27.95
Conan	27.95	Sierra On Line	
Dig Dug	20.95	Frogger	24.95
PacMan	20.95	King's Quest	34.95
Zaxxon IIc	20.95	Sir Tech	
Epyx		Wizardry 1	34.95
Rogue	20.95	Wizardry 2	24.95
Summer Games	27.95	Wizardry 3	27.95
Pitstop	27.95	Wizardry 4	29.95
Hayden		Spectrum	
Holy Grail	34.95	Galo	27.95
Sargon III	34.95	Spinnaker/Telearium	
Infocom		Amazon	27.95
Cultthroats	27.95	Dragon World	27.95
Deadline	34.95	Fahrenheit 451	27.95
Enchanter	27.95	Rendezvous w/Rama	27.95
Hitchhiker's G	27.95	Shadow Keep	27.95
Sorcerer	20.95	Strategic Simulations	
Suspect	29.95	Baltic 85	24.95
Witness	27.95	Battle Normandy	27.95
Zork 1	27.95	Carrier Force	37.95
Zork 2.3 (ea)	29.95	Computer Ambush	37.95
Micro Lge. Sports		Computer Quarterback	27.95
Baseball	27.95	Computer Baseball	27.95
Microprose		Germany 85	37.95
F-15 Strike	24.95	Kampgruppe	37.95
NATO Commander	24.95	Objective Kursk	27.95
Solo Flight	24.95	Questron	34.95
Crusade in Europe	27.95	Reforged 88	37.95
Mindscape		War with Russia	49.95
Crossword Magic	34.95	Sublogic	
Halley Project	27.95	Fight Simulator II	34.95

BC BUSINESS COMPUTERS
OF PETERBOROUGH
Gollan Co., Inc.

766 RT. 101 W. • P.O. Box 389 • Peterborough, NH 03458

ORDERS ONLY 800-845-3003

QUESTIONS
603-924-9406

FREE SHIPPING
CONTINENTAL USA/UPS ONLY
APO/FPO WELCOME

GOLEM COMPUTERS

APPLE

SOFTWARE/HARDWARE
AT SUPER SAVINGS

PLACE ORDERS TOLL FREE
1-800-345-8112



PA 1-800-662-2444



	LIST PRICE	GOLEM PRICE
HARDWARE SPECIALS		
MICROMODEM IIE/SMARTCOM (HAYES)	210.00	
SMARTMODEM 1200 RS-232 (HAYES)	393.00	
PROMODEM 1200A W/SOFTWARE (PROMETHEUS)	293.00	
KOALA GRAPHICS TABLET W/SFT (KOALA)	73.00	
JOYSTICK MACH III W/FIRE BUTTON (CH PRODUCTS)	33.00	
PRINTER KX-1091 DOT MATRIX/PAR (PANASONIC)	262.00	
DISK DRIVE SLIM IIc (MICROSCI)	186.00	
MONITOR 210 COLOR COMP/RGB 12" (TAXAN)	234.00	

EDUCATION		
TYPING TUTOR III	49.95	30.00
MATH BLASTER	49.95	30.00
GRAMMAR EXAMINER	44.95	27.00
WORD ATTACK	49.95	30.00
EARLY GAMES FOR YOUNG CHILDREN	34.95	21.50

HOME		
DOLLARS AND PENSE	100.00	59.00
DOLLARS AND PENSE IIc	119.95	66.00
CROSSWORD MAGIC	49.95	30.00
MICRO COOKBOOK	40.00	23.50
HOME ACCOUNTANT	74.95	44.50

UTILITIES		
THE PRINT SHOP	49.95	30.00
PRINT SHOP GRAPHICS #1	19.95	13.00
ASCII EXPRESS PROFESSIONAL	129.95	76.00
GLOBAL PROGRAM LINE EDITOR	49.95	30.00
SIDEWAYS	60.00	33.00
TURBO PASCAL	54.95	33.00

WORD PROCESSING		
BANK STREET WRITER	69.95	41.00
BANK STREET SPELLER	69.95	41.00
SENSIBLE SPELLER IV	125.00	66.00
HOMEWORD	69.95	41.00
PFS: WRITE IIc	125.00	70.00

BUSINESS		
PFS: FILE, REPORT, GRAPH	ea. 125.00	70.00
BPI AP, AR, INV, PAYROLL, GL	ea. 395.00	233.00
MULTIPLAN (APPLE DOS)	95.00	57.00
THINK TANK	150.00	81.00
BACK TO BASICS ACCT SYSTEM (IIc)	195.00	98.00

STRATEGY		
FLIGHT SIMULATOR II	49.95	32.00
SARGON III	49.95	30.00
MILLIONAIRE	49.95	30.00

ARCADE		
SUMMER GAMES	40.00	26.00
LODE RUNNER, CHOPFLIFTER	ea. 34.95	22.00
DIG DUG, DONKEY KONG	ea. 34.95	22.00
MINER 2049er	40.00	23.25

FANTASY		
ULTIMA II, III	ea. 59.95	33.50
WIZARDRY	49.95	30.00
LEGACY OF LILYGAMYN	39.95	24.50
KNIGHT OF DIAMONDS	34.95	23.00

ADVENTURE		
HITCHHIKER GUIDE TO THE GALAXY	39.95	24.25
ZORK II, III	ea. 44.95	26.75
DEADLINE, SUSPENDED	ea. 49.95	29.75
CUTTHROATS, ENCHANTER	ea. 39.95	24.25
MURDER BY THE DOZEN	34.95	23.00

PLACE ORDERS TOLL FREE
1-800-345-8112 • PA 1-800-662-2444

ALL ITEMS SUBJECT TO AVAILABILITY
PRICES SUBJECT TO CHANGE WITHOUT NOTICE

To order call toll free or send check or money order VISA/MC C.O.D. orders welcome. Personal and company checks allow 10 working days to clear. Specify if to backorder or to send refund. California residents add 6% sales tax. Include phone number with order. Shipping and handling: All shipments U.P.S. if possible. Continental U.S. add \$2.00 for 1 to 3 items. 4 to 6 items add \$4.00. APO, FPO Alaska, Hawaii and Canada add \$3.00 per item. 2nd day air add \$3.00. All hardware purchases are prepaid of VISA/MC; shipped U.P.S. - include 5% for shipping & handling. Foreign orders add 10% and include check drawn on U.S. bank. C.O.D. orders add \$1.90. Mail orders to:

GOLEM COMPUTERS
P.O. BOX 6698 • WESTLAKE VILLAGE, CA 91359
Apple is a trademark of Apple Computers, Inc.

PASCAL PRIMER

Table 1. General Turtle Graphics commands for initializing the display and selecting drawing colors.

Command	Description
FILLSCREEN(COLOR)	Fills entire display (or inside boundaries defined by VIEWPORT) with this color. Figure 1 lists available colors.
GRAFMODE	Switches from text to graphics without disturbing either display.
INITTURTLE	Turns on and erases the graphics display. Positions turtle facing right (0 degrees) at screen center.
PENCOLOR(COLOR)	Next turtle movement will leave a trail of this color.
TEXTMODE	Switches from graphics to text without disturbing either display.
VIEWPORT(LEFT, RIGHT, BOTTOM, TOP)	Sets boundaries of active graphics display. Lines drawn out of bounds are invisible.

Table 2. Turtle Graphics commands to move the turtle.

Command	Description
MOVE(DISTANCE)	Moves turtle the specified distance along its current angle, leaving a trail in the current PENCOLOR or no trail if the color is NONE.
MOVETO(X, Y)	Sends the turtle directly to screen coordinate (X,Y), leaving a trail in the current PENCOLOR.
TURN(DEGREES)	Turns the turtle from its current heading the number of degrees designated. Negative values turn the turtle clockwise, positive values counterclockwise.
TURNTO(ANGLE)	Turns the turtle to the specified angle. Angles may be any integer value, but are limited by Pascal to -359 to +359 degrees. Zero degrees faces right.

Table 3. Turtle Graphics functions that return values.

Command	Description
TURTLEANG : integer;	Returns the current heading, 0 to 359 degrees, of the turtle.
TURTLEX, TURTLEY : integer;	Returns current X (TURTLEX) or Y (TURTLEY) coordinate of the turtle position.
SCREENBIT(X, Y) : Boolean;	Returns FALSE if the pixel at coordinate (X,Y) is colored BLACK. Returns TRUE if the position is set to some visible color.

Table 4. Turtle Graphics text and pattern-drawing commands.

Command	Description
CHARTYPE(MODE)	Sets drawing mode for WCHAR and WSTRING. Table 5 lists available modes.
DRAWBLOCK(SOURCE, ROWSIZE, XSKIP, YSKIP, WIDTH, HEIGHT, WSCREEN, YSCREEN, MODE)	Transfers bits in SOURCE directly to screen. Used to draw animated figures and other complex patterns with a single command.
WCHAR(CH)	Writes the character CH at the current turtle position. After writing, the turtle is positioned seven pixels to the right.
WSTRING(S)	Writes the string S at the current turtle position. Calls WCHAR for each character in the string.

words form a compound statement, which the FOR loop treats as a unit. With a single-statement FOR loop, as in the counting examples above, BEGIN and END are unnecessary.

Procedure Box

So you can use your box-drawing program several times, store it in a *procedure*—a named collection of statements and other declarations, similar to a subroutine in BASIC. Wherever you want to draw a box in your program, just write Box to call the procedure. You must define the procedure, however, before you use it the first time.

Listing 1 draws a 50-unit square blue box. (Don't enter the reference line numbers or colons.) The procedure beginning at line 2 resembles a complete program, but starts with the key word PROCEDURE, and ends with a semicolon at line 11.

Procedures can have their own constant, type, and variable declarations. In **Listing 1**, procedure Box declares a local integer variable, Side. Because Side is declared inside the procedure, it doesn't exist anywhere else in the program—its scope is limited to the procedure in which it is declared.

Step to It

It's easy to add motion to Turtle Graphics programs. A few minor changes to the box procedure produces intricate displays like those in **Figures 2** and **3**.

First, replace the literal value 50 with the integer variable Distance, because not all boxes are 50 pixels square (**Listing 2**, lines 1-2). Next, use another FOR loop to vary the Distance variable from 10 to 150 (lines 23-27). The turtle turns Step degrees to the right (negative Steps) or left (positive Steps) after it draws each box. (The program lets you enter values for Step in line 18.) Changing the distance at the same time produces the patterns.

REPEAT Loops

Listing 2 also demonstrates a second kind of Pascal loop, REPEAT...UNTIL, which begins at line 16 with the key word REPEAT and ends at line 31 with the key word UNTIL and an expression. The program executes the remaining statements repeatedly until

1600k IIe!

Why settle for less when you can buy Checkmate Technology's **State-Of-The-Art MULTIRAM IIe™** from Coit Valley Computers with the following features:

- **DIRECT SUBSTITUTE FOR RAMWORKS™** or Apple Extended 80 column cards. Because **MULTIRAM** follows Apples' strict guidelines, it **RUNS ALL 3rd PARTY SOFTWARE** written for either card.
- **UP TO 768k MAIN BOARD MEMORY - 50% MORE THAN RAMWORKS!**
- **UP TO 768k MORE OPTIONAL PIGGYBACK BOARD MEMORY + FREE RGB ON THE SAME BOARD** - and it won't interfere with cards in slot-1! **A TOTAL OF 1600K IIe MEMORY AT A LOWER PRICE!**
- **FREE RAM DISK, RAM TEST and APPLEWORKS™ EXPANDER SOFTWARE** that can automatically load AppleWorks entirely into memory, run 20 x faster, increase the Desktop to 1100k, auto-segment large files onto multiple disks, and store up to 5100 records!
- **FREE SOFTWARE UPDATES** exclusively at Coit Valley Computers.
- **TRUE 16 BIT CO-PROCESSOR PORT** with linear connected data banks needed for easy Co-Processor access.
- **EXCLUSIVE 5 YEAR WARRANTY THAT, UNLIKE RAMWORKS, INSURES COVERAGE NO MATTER WHERE YOU BOUGHT IT!**

AVAILABLE NOW AT LOWER COST AND A MONEY BACK SATISFACTION GUARANTEE from Coit Valley Computers*. For a limited time, we'll even give an **EXTRA 64k OF MEMORY FREE** with each 256k or 512k MULTIRAM IIe card! **CALL FOR CURRENT PRICING!**

	OUR LOW PRICE		OUR LOW PRICE
64k MultiRam IIe	155.	1536k MultiRam IIe	699.
128k MultiRam IIe	173.		/FREE RGB
320k MultiRam IIe	225.	64k Memory Expander Chips (8)	25.
576k MultiRam IIe	285.	256k Memory Expander Chips (8)	75.
768k MultiRam IIe	345.	Pico™ Slimline Drive IIc, IIe, II+	178.
1024k MultiRam IIe	599./FREE RGB	Apple IIe Enhancement Kit	62.
1280k MultiRam IIe	654./FREE RGB	Promodem 1200A Modem	369.

640k 16-BIT IIc!

Checkmate Technology's **State-Of-The-Art MULTIRAM IIc** can expand your Apple IIc up to 640k and has a **16-bit PROCESSOR** option. It comes with the same **FREE APPLEWORKS EXPANDER, Ram Disk, and Ram Test** software as **MULTIRAM IIe** and is available now from Coit Valley Computers. **CALL FOR CURRENT PRICING!**

- **LOW COST EASILY INSTALLED 16-BIT CO-PROCESSOR OPTION (\$145)** - unavailable from the competition.
- **NO JUMPER WIRES OR CLIPS REQUIRED FOR INSTALLATION** - unlike the competition.
- **ALL CHIPS ARE SOCKETED AND REMOVABLE** - unlike the competition.
- **USES ABOUT 50% LESS POWER** than the competition.
- **IMPROVED KEYBOARD SUPPORT** to avoid spongy feeling keys.
- **MONEY BACK SATISFACTION GUARANTEE** from Coit Valley Computers*.
- **5 YEAR WARRANTY THAT, UNLIKE THE COMPETITION, INSURES COVERAGE NO MATTER WHERE YOU BOUGHT IT!**

	OUR LOW PRICE		OUR LOW PRICE
256k MULTIRAM IIc	299.	16-BIT CO-PROCESSOR KIT	145.
512k MULTIRAM IIc	369.	(optional for either size)	

Terms: For fastest delivery send Cashier's/Certified check, Money Order. C.O.D. (add \$5) & personal checks accepted (allow 14 days). Add \$4 shipping & phone # to all orders. Add 3% for P.O.'s & MasterCard/Visa (include #/expir). Tex res add 6 1/8% tax. **CALL FOR LATEST PRICES!**

MultiRam, Ramworks, Appleworks, Pico, respective trademarks of Checkmate Technology, Applied Engineering, Apple Comp. WGE Int. *Return your MultiRam within 10 days of receipt in original condition and receive complete refund less tax.

COIT VALLEY COMPUTERS (214) 234-5047
14055 Waterfall Way Dallas, Texas 75240

CDA
COMPUTER SALES
MAIL ORDER WORLDWIDE
SINCE 1977

AD 1016

VISA MasterCard

NO SALES TAX COLLECTED
(N.J. Residents add 6%)

APPLE IIe SYSTEM

- APPLE IIe Computer
- APPLE New Uni-drive complete with/PRODOS & Controller
- APPLE 2nd uni-drive
- ZENITH Green Monitor
- Extended 80 Column Card
- EPSON FX-85 Printer
- GRAPPLER + Printer Interface
- Table top printer stand
- Box of 10 diskettes
- Package of computer paper
- Extra Printer Ribbon
- System Dust Cover
- Printer Dust Cover



NOW \$1,849

★SAVE! \$600.
LIST - \$2,449

OKIDATA 192 PKG.

Microline 192 for IIc or Macintosh:

- Okidata 192 160 CPS Imagewriter Compatible Printer
- Kensington Printer Stand
- Extra Ribbon
- Case of Computer Paper (1800 Sheets)
- Printer Dust Cover
- IIc Printer Cable

List \$639.99 **NOW \$449**
For IIe package includes grappler+ add.\$50.00

The 192 Printer features a near letter quality mode and a print speed of 160 characters per second!

MODEM MADNESS

HAYES MICROCOMPUTER PRODUCTS

Micromodem IIe 300 Baud (includes software)	\$199	\$139
Smartmodem 300 for IIc (includes software & cable)	\$239	\$169
Smartmodem 300	\$199	\$149
Smartmodem 1200	\$599	\$399
Smartmodem 2400	\$899	\$639
Smartcom II for Macintosh	\$149	\$109

PROMETHIUS PRODUCTS

Promodem Mac Pac (includes software & cable)	\$549	\$349
Promodem A internal for IIe (ROM software)	\$449	\$299
Promodem 1200	\$495	\$329

MONTHLY SPECIAL

APPLIED ENGINEERING

Ramworks 64K	\$179	\$149	Z-80c (IIc)	\$159	\$129
Ramworks 128K	\$249	\$169	Viewmaster	\$139	\$119
Ramworks 256K	\$299	\$169	Time Master	\$129	\$106
Ramworks 512K	\$399	\$249	RGB Option	\$129	\$106
			Z-RAM 256K IIc	\$449	\$349

NEW UNIDISK by APPLE

Quiet 1/2-height Drive
NEW from APPLE
LIST \$399 NOW \$279
Buy "2" and receive a FREE controller card!

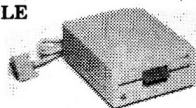

ORDERS ONLY 800-526-5313

Inquiries, Price Quotes, and in N.J. call 201-728-8080.

ORDERING INFORMATION AND TERMS:
Mail to: CDA COMPUTER SALES

31 Marshall Hill Road, West Milford, N.J. 07480

Include address and phone number. Shipping, handling and insurance are additional. Add 2% UPS Ground (\$3.50 minimum) UPS Blue 6% (\$5.00 minimum) NO. C.O.D. Cashiers checks, moneyorders and credit cards ship immediately. Personal and company checks allow 15 days ORDER 9am-7pm EST Monday-Friday, Saturday 10-4. OUR REFERENCES: We have been selling computers since 1977. Our bank is First Fidelity Bank, West Milford, N.J. D&B listed. **SATISFACTION GUARANTEED!** If you are not 100% satisfied, return within 7 days for a full refund. ORDER VIA COMPUSERVE You may place orders via COMPUSERVE'S ELECTRONIC MALL 24 hours a day, 7 days a week.

PASCAL PRIMER

Table 5. Use these mode numbers with CHARTYPE and DRAWBLOCK to tell Turtle Graphics how to display characters and bit patterns. PB is the pattern bit; SB is the screen bit at drawing position. Each mode sets screen bits according to a Boolean expression.

Mode	Expression	Mode	Expression
0	FALSE	8	PB AND SB
1	NOT (PB OR SB)	9	PB = SB
2	PB AND (NOT SB)	10	PB
3	NOT SB	11	PB OR (NOT SB)
4	(NOT PB) AND SB	12	SB
5	NOT PB	13	(NOT PB) OR SB
6	PB XOR SB	14	PB OR SB
7	NOT (PB AND SB)	15	TRUE

Step equals zero—the expression Step = 0 is true.

Unlike the FOR loop, which automatically increases or decreases a variable by one each time through the loop, the REPEAT...UNTIL loop requires that you increment/decrement the variable yourself. The program below shows this by using a REPEAT loop to count to ten:

```
I := 0;
REPEAT
  I := I + 1;
  WRITELN(I)
UNTIL I = 10;
```

If you forget to include a variable counter, the loop will never end. (You can often break out of such a loop, by the way, by typing control-P or pressing the escape key and then control-P. Try it several times before giving up and hitting control-reset.)

Functions

A function is a procedure that returns a value. You write functions similar to procedures, but, because a function returns a value, you must always use its name in an expression.

Listing 3, a demonstration of one way to draw circles, shows an example of a Pascal function. Function Radians (lines 10-14) returns a real number equal to a certain angle converted to radians. (There are 2π radians in a circle.) You must express angles as radians because that's what Pascal's SIN and COS functions expect.

SIN and COS are two of several transcendental functions not normally available in Apple Pascal. To include them in the program, add USES Transcend to the program declaration (lines 1-2) in addition to TurtleGraphics.

Parameters

Function Radians in Listing 3 has a single parameter, angle, declared inside parentheses after the function name in line 10. The function uses this formal parameter as it does any other variable. By passing an actual value to the function's formal parameter, you can give the function a value to act upon. The equation below, for example, sets a real-number variable R equal to the number of radians in 45 degrees:

```
R := Radians( 45 );
```

Procedures may also have parameters (lines 16-28). Here, procedure DrawCircle has a single parameter, Radius, which defines the size of the circle.

WHILE Loops

Inside the DrawCircle procedure is the third and final kind of loop state-

Listing 1. Basic box program.

```
0: PROGRAM BlueBox; USES TurtleGraphics;
1:
2: PROCEDURE Box;
3: VAR
4:   Side : integer;
5: BEGIN
6:   FOR Side := 1 TO 4 DO
7:     BEGIN
8:       Move( 50 );
9:       Turn( 90 )
10:    END
11: END;
12:
13: BEGIN
14:   InitTurtle;
15:   PenColor( Blue );
16:   Box;
17:   readln;
18:   TextMode
19: END.
```

A computer store's service at mail-order prices.

ment available in Pascal, the WHILE loop. This loop is similar to a REPEAT...UNTIL loop except that the program tests its condition before the loop begins.

The following example counts to ten using a WHILE loop:

```
I := 0;
WHILE I < 10 DO
BEGIN
  I := I + 1;
  WRITELN( I )
END;
```

As in FOR loops, BEGIN and END statements must surround multiple statements, forming a single compound statement. The program executes all statements between BEGIN and END while some condition, here I < 10, remains true. If you replace I := 0 with I := 20, the WHILE loop which always executes at least once.

When you run Listing 3, try a radius of 50 and a step size of 18. Since the program draws a circle as a many-sided polygon, the best step

Listing 2. Creating patterns with boxes.

```
0: PROGRAM Boxes; USES TurtleGraphics;
1: VAR
2:   Distance, Step : integer;
3:
4: PROCEDURE Box;
5: VAR
6:   Side : integer;
7: BEGIN
8:   FOR Side := 1 TO 4 DO
9:     BEGIN
10:      Move( Distance );
11:      Turn( 90 )
12:    END
13:  END;
14:
15: BEGIN
16:   REPEAT
17:     write( 'Step? (0 to quit) ' );
18:     readln( Step );
19:     IF Step <> 0 THEN
20:       BEGIN
21:         InitTurtle;
22:         PenColor( White );
23:         FOR Distance := 10 TO 150 DO
24:           BEGIN
25:             Box;
26:             Turn( Step )
27:           END;
28:           readln;
29:           TextMode
30:         END
31:       UNTIL Step = 0
32:     END.
```

Because we're both.

Our commitment to service is why so many private individuals, schools and Fortune 1000 companies choose Micro City. If in the Chicago area, please visit our retail store at 24W500 Maple Ave., Naperville, IL 60540.



HARDWARE for APPLE

DISK DRIVES FOR APPLE	
Super 5 Direct Slim Drive	
II+, //e (year warranty).....	\$159
Super 5 Dir. Slim Drive //e....	165
PACE AP-50 Full Height	
for II+, //e.....	145
PACE AP-50 Full Hgt. //e....	149
Mitsuba Controller II+	
or //e.....	45
Mitsuba Drive for Mac.....	259
GENERIC HARDWARE	
16K Ram, II+.....	39
Z-80 Card, II+, //e.....	42
Cooling Fan, 2 outlets, Surge	
Protect, II+, //e.....	29
Joystick, fire button, (Spec. II+	
or //e).....	29
Computer Case, II+.....	59
Replacement Keyboard, II+.....	69
Case w/built-in Numeric	
Keypad.....	119
RF Modulator.....	19
Power Strip, Surge Protect.	
6 Outlets.....	19
ADVANCED LOGIC SYSTEMS	
CPM Card, II+, //e.....	249
Business Card w/T-Maker	
for II+, //e.....	269
Z Engine II+, //e.....	129
Smartem II, II+, //e.....	129
AST	
Multifunction Board, //e.....	189
CH PRODUCTS	
Mach III Joystick (Spec. II+,	
//e, //c).....	38
Mach III w/fire button (Spec. II+,	
//e, //c).....	45
Paddlestick Spec. II+, //e, //c).....	38
CALIFORNIA COMP. SYS.	
Clock Calendar.....	89
7711 Asvnc Ser. Interface.....	99
COMPUTER ACCESSORIES	
Power Director P22.....	89
COMREX	
A-B Switch Box (spec. par/ser).....	59
KENSINGTON MICROWARE	
System Saver Fan, II+, //e.....	65
KOALA TECHNOLOGIES	
Koala Pad Plus w/sft.	
//e, //c).....	69
KAT for Mac.....	149
Muppet Learning Keys w/SFT	
for //e, //c).....	55
Gibson Light Pen.....	149
MacVision Digitizer.....	179
MICROSOFT	
SoftCard II.....	289
Premium SoftCard //e.....	269
Macenhancer.....	179
MICROTEK	
Dumpling-GX.....	79
Magnum 80me 80 Col	
64K for //e.....	115

MITSUBA

80 Col w/64K, //e.....	\$ 89
MOUSE SYSTEMS	
A+ Optical Mouse, //e, Mac....	79
ORANGE MICRO	
Grappler +, II+, //e.....	89
Buffered Grappler +, II+, //e....	149
Bufferboard II+, //e (Spec. your	
Interface).....	79
Serial Grappler +, II+, //e.....	89
Bufferpak.....	115
Bufferpak/Ser. Grappler	
Combo.....	179
Orange Interface, II+, //e.....	59
Hotlinks for //e.....	65
Grappler C for //e.....	99
PERSONAL COMP. PROD.	
Appli-Card 6 MHz/64K	
memory II+, //e.....	269
Appli-Card 6 MHz/64K RAM	
Extender II+, //e.....	349
Appli-Card 4 MHz/128K	
memory II+, //e.....	249
PRACTICAL PERIPHERALS	
GraphiCard (Graphics int.).....	79
PrinterFace.....	59
SeriALL (RS 232).....	109
Switchport for //e.....	89
Pro Clock (spec II+, //e, //c)....	89
Microbuffer II, spec. printer	
16K spec. par/ser.....	99
32K spec. par/ser.....	115
Microbuffer II+ (both par & ser)	
16K.....	135
32K.....	145
64K.....	165
Microbuffer In-Line External	
32K (spec. par/ser).....	189
64K (spec. par/ser).....	219
Microbuffer/E Internal for Eps	
Printers	
16K Parallel.....	115
32K Parallel.....	135
64K Parallel.....	175
8K Serial.....	115
16K Serial.....	125
32K Serial.....	145
QUADRAM	
eRam 80 (80 Col, 64K, //e).....	109
Multicore w/OK II+, //e.....	179
Multicore w/256K.....	299
Ext. Multi function Card	
for II+, //e.....	189
Pro Dos Clock/cal II+, Ile.....	79
Buffered Serial Adapter	
64K, II+, //e.....	119
STREET ELECTRONICS	
Echo Plus speech	
synthesizer.....	119
SWEET MICRO SYSTEMS	
Mockingboard A (Music).....	89
Mockingboard B (Speech).....	79
Mockingboard C (A+B).....	139
Mockingboard D, //e.....	149

TITAN SYSTEMS

64K Ram Card.....	\$159
128K Ram Card.....	199
Accelerator //e, II+, //e.....	219
TRACK HOUSE	
Programmable 10-Key Numeric	
Keypad for //e.....	139
VIDEO 7	
RGB Adapter for //e.....	105
RGB 80/64 for //e.....	139
Slot 7 RGB II+, //e.....	115
Mousestick for Mac.....	55
VIDEX	
Ultraterm (132 Col).....	199
Lower Case Chip.....	25
Visicale Preboot.....	45
Apple Writer II Preboot.....	22
Ult. Visicale Preboot.....	54
Ult. Appewriter Preboot.....	24
WICO	
SmartCard w/ Mouse (specify	
II+ or //e).....	149
SmartCard w/ Ball (specify	
II+ or //e).....	149
PRINTERS	
COMREX (Div. of Epson)	
CR-//e (Same as Brother	
HR-15XL) Spec par/ser.....	299
EPSON	
CALL	
NEC SPINWRITER	
NEC 3510, Serial.....	1050
NEC 3530, Parallel.....	1050
Bi-Dir. Tractor, 3500 Series.....	169
Cut Sheet Feed, 3500 Series.....	689
OKIDATA	
CALL	
PANASONIC	
KX-P1090, Parallel.....	189
KX-P1091, Parallel.....	259
KX-P1092, Parallel.....	369
KX-P1093 Par/Ser.....	439
KX-P3151 LQ Par.....	439
SILVER REED	
EXP-400 Par.....	229
EXP-400 Serial.....	239
EXP-500 LQ (spec. Par/Ser).....	309
EXP-550 LQ (spec. Par/Ser).....	419
EXP-770 LQ (spec. Par/Ser).....	669
TOSHIBA	
P1340 LQ (spec. Par/Ser).....	559
P351 LQ, Par.....	1199
P351 LQ, Par & Ser.....	1229
P351 Bi-Direct Tractor.....	159
P351 Auto Sheet Feeder.....	619
MONITORS	
AMDEK	
V300 Green.....	132
V300A Amber.....	139
Color 300 (Comp).....	239
Color 500 (RGB Comp).....	319
Color 600 Hi/Res RGB.....	409
Color 700.....	449
Color 710 Super Hi. RGB.....	539

TAXAN

12" Hi/Res Amber.....	\$129
410-80 RGB Int.....	119
410-02 RGB-2 Int.....	99
410-8064 RGB Int, //e.....	179
ZENITH	
ZVM-123A 12" Green.....	99
ZVM-122A 12" Amber.....	99
ZVM-131 Color Comp.	
40 Col.....	199
MODEMS	
HAYES	
Smartmodem 300.....	145
Smartmodem 1200.....	385
Smartmodem 2400.....	619
Micromodem //e w/SFT.....	145
Smartmodem 300 w/SFT	
for //e.....	165
KENSINGTON MICROWARE	
Accessories: Portable Modem	
for Mac, //e.....	109
MICROCOM	
ERA 2 for //e.....	319
Macmodem w/sft.....	409
Macmodem 2400 w/sft.....	589
NOVATION	
Apple CAT II.....	189
212 Apple Cat Upgrade.....	219
212 Apple Cat System.....	349
Expansion Module.....	29.95
Smart Cat Plus 300/1200 Baud	
w/ Software for Mac.....	299
2400 Baud.....	449
J-CAT.....	89
PROMETHEUS	
Promodem 1200 Ext.....	305
Promodem 1200A w/Software	
for II+, //e.....	305
Transportable Promodem	
300C for //e.....	149
Promodem 1200M for Mac.....	349
ZOOM TELEPHONICS	
Zoom Modem //e Apple.....	119
Zoom Modem //e Plus.....	139
DISKETTES	
BONUS	
SS DD Box of 11.....	12.95
MAXELL	
SS DD Box of 10.....	17
VERBATIM	
SS DD Box of 10.....	19
DS DD Box of 10.....	25
SS DD 3.5" Box of 10.....	29
Disk Drive Analyzer.....	29.95
Disk Drive Head Clean. Kit.....	8.95
Cleaning Disks - 10.....	2
XIDEX	
SS DD Box of 10.....	13.95
DS DD Box of 10.....	14.95
SOFTWARE	
PLEASE CALL!	

Please call for FREE catalog and CURRENT LOW PRICES!

1-800-548-8244 (Orders Only)
312-810-0037 (Customer Service, Product Info
Catalog Requests & Illinois Orders)

Hours: Mon - Fri 8:30 - 5:30, Saturday 10 - 4

Check, money order, Visa, MasterCard or American Express (include # & exp. date). \$2.50 shipping & handling in Continental U.S. (Alaska, Hawaii & foreign add 5%, min. \$5.00). Personal/company checks allow 2 weeks. Please add 2% for credit card use. Illinois residents add 6.25% sales tax. Dealer inquiries invited. Prices subject to change.

School & corporate P.O.'s welcome.



A Division of Pace Systems, Inc.
P.O. Box 571
Downers Grove, IL 60515



FREE? DISKETTES

SAVE MONEY! Apple II series users can use the diskette flip side, if another "write enable" notch is correctly made.

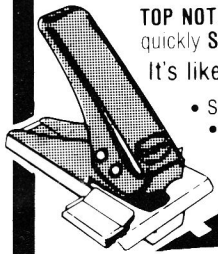

TOP NOTCH by QUORUM quickly SOLVES that PROBLEM. It's like FREE DISKETTES!

- Stainless Steel Guide
- Easy Leverage Handle
- Clippings Catcher
- Square Notch Cut
- Black Finish

Lifetime Warranty

Awarded the only A+ GRADE in a comparison test published by the INTERNATIONAL APPLE CORE.

"The best I've found..."

IAC Reviewer

Certifix™

BE SAFE! The flipside of a single sided disk may have flaws. Any disk is CERTIFIED 100% ERROR FREE with CERTIFIX. IT "LOCKS OUT" BOTH DOS 3.3 & ProDOS DISK FLAWS.

- LOCKS OUT ProDOS & DOS 3.3 FLAWS
- SAVES STATUS REPORT ONTO DISK
- AUTOMATIC ProDOS/3.3 FORMATTING
- CREATE 40 trk DISKS & SYSTEM MASTER
- RECORDS TEST DATE onto disk
- NOT COPYPROTECTED

FREE CERTIFIX BONUS PROGRAMS

- Undelete DOS 3.3 files
- Test and Adjust Disk Drive Speed

Prevent Data Loss!

CERTIFY & FIX every disk with CERTIFIX!



Get THE BEST!

Ask our Customers:

U.S. National Bureau of Standard
TRW • IBM • Digital Research • AT&T
U.S. Naval Weapons Research Center
Alcoa • Rockwell International
General Electric Corporation

FREE!

64 Write Protect Tabs
32 Diskette Labels
If you get the
DISKETTE FLIP-KIT
which contains
TOP NOTCH and CERTIFIX

*100% Money Back
Satisfaction Guarantee!*

DISKETTE FLIP-KIT only \$29.95

TOP NOTCH is \$14.95

CERTIFIX is just \$24.95

Add \$2 s/h • CA add 6.5% tax

For your nearest dealer
or to order direct.

CALL TOLL FREE

1-800-222-2824

In CA: 1-800-222-2812

From 8 am - 5 pm PST



Dealers Invited

QUORUM INTERNATIONAL, Untd.
INDUSTRIAL STATION P.O. BOX 2134 I.C.
OAKLAND, CA 94614

Circle 41 on Reader Service Card.

PASCAL PRIMER

sizes are factors of 360. Small step sizes produce round-looking circles, while large steps create polygons.

Pascal News

This month, I'm going to start including news of interesting Apple Pascal products. What I look at will be totally arbitrary, and I don't intend to

do complete reviews. Please write directly to suppliers for more information and accurate prices.

If you use any products you think would interest other Apple Pascal owners, drop me a line. If you are selling a product, I'll try to mention it if it's related to Pascal, but no promises.

Listing 3. Drawing circles.

```

0: PROGRAM Circles;
1: USES
2:   TurtleGraphics, Transcend;
3: CONST
4:   pi           = 3.141593;
5:   Xcenter     = 140;
6:   Ycenter     = 96;
7: VAR
8:   radius, stepsize : integer;
9:
10: FUNCTION Radians( angle : integer ) : real;
11: (* Return angle as radians *)
12: BEGIN
13:   Radians := ( abs( angle mod 360 ) * pi / 180 )
14: END; (* Radians *)
15:
16: PROCEDURE DrawCircle( Radius : integer );
17: VAR
18:   angle : integer;
19: BEGIN
20:   pencolor( none );
21:   angle := 0;
22:   WHILE angle <= 360 DO
23:     BEGIN
24:       moveto( round( radius * cos( radians( angle ) ) ) + Xcenter,
25:             round( radius * sin( radians( angle ) ) ) + Ycenter );
26:       pencolor( white );
27:       angle := angle + stepsize
28:     END;
29:   pencolor( none )
30: END; (* DrawCircle *)
31:
32: BEGIN
33:   REPEAT
34:     writeln;
35:     write( 'Radius? (0 to quit) ' );
36:     readln( radius );
37:     IF radius > 0 THEN
38:       BEGIN
39:         write( 'Step size (1 .. 45)? ' );
40:         readln( stepsize );
41:         IF ( stepsize >= 1 ) AND ( stepsize <= 45 ) THEN
42:           BEGIN
43:             initturtle;
44:             DrawCircle( radius );
45:             readln;
46:             TextMode
47:           END
48:         END
49:       UNTIL radius = 0
50:     END.

```

● USUS is the UCSD Pascal System User's Society. Write to the USUS secretary at P.O. Box 1148, La Jolla, CA 92038 for membership information. USUS publishes a thick newsletter (somewhat erratically in the past, but with better frequency of late). The society also maintains an impressive software library. You can even get the source code to an early version of UCSD Pascal, upon which Apple Pascal was based.

● Any German readers out there? My book *Pascal Programs for Games and Graphics* was recently translated into German by Pandabooks, Bismarckstr. 67, D-1000, Berlin 12. I can't read it; maybe you can.

● Finally, take a look at Kyan Pascal, by Kyan Software, 1850 Union Street, Suite 183, San Francisco, CA 94123. Company owner Tom Eckmann tells me that a new version of Kyan Pascal will be available by the time you read this. The new compiler fixes several bugs, supports 80-column displays, and recognizes Apple //e keyboard keys. Owners of earlier versions can upgrade for free.

Kyan Pascal runs under ProDOS—not the Apple Pascal operating system—but compiles to 6502 machine language instead of p-code, as does Apple Pascal. (ProDOS is supplied on the Kyan disk.) The 108-page Kyan manual could use a rewrite, but seems to be complete and easy to follow. At \$69.95, this is a well-done product that deserves a serious look from Apple owners interested in Pascal programming. My guess is you'll be hearing more about Kyan in the future.

And Finally. . .

This month I introduced Pascal Turtle Graphics, and showed you how to use procedures, functions, and three loops—FOR, REPEAT. . .UNTIL, and WHILE. There's a lot more to Turtle Graphics than would fit in this one column—and Pascal graphics is a subject I'll return to again and again. ■

Tom Swan is the author of several computer books, including Pascal Programs for Business, Pascal Programs for Games and Graphics, and Pascal Programs for Data Base Management, published by Hayden Book Company. Address correspondence to Tom at P.O. Box 206, Lititz, PA 17543. Please enclose a self-addressed, stamped envelope if you want a personal reply.

inCider



BACKUP PROTECTED SOFTWARE with COPY II PLUS™ ver. 5

From the team who first brought you COPY II PLUS in 1981 comes a completely updated disk backup utility for your Apple // computer. New features include:

- **Fully automatic bit copy***. All parameters are stored on disk. Simply type in the name of the program you wish to backup, and COPY II PLUS does the rest!
- **New utilities** including Alphabetize Catalog, Fast 2-pass Disk Copy on a //c or //e, and an all-new Sector Editor.
- **Supplied on a standard DOS** diskette. Runs on the Apple //, Apple //+, Apple //e, Apple //c. Requires 64K and one or two disk drives.

Increase the power of your Apple // ...

Use COPY II PLUS™ 5.0

Call M-F 8-5:30 (W. Coast time) with your   : 503/244-5782.
Or send a check (add \$3 s/h, \$8 overseas) to



\$39.95

**CENTRAL POINT
Software, Inc.**

9700 SW Capitol Hwy. #100
Portland, OR 97219

* We update Copy II Plus regularly to handle new protections; you as a registered owner may update at any time for 1/2 price! (To update, just send original disk and \$20.)

This product is provided for the purpose of enabling you to make archival copies only.

Circle 60 on Reader Service Card.

GIVE YOUR PRINTER A FACELIFT™

FACELIFT works with your APPLE II, IIe and II+ to set as many as 92 type faces, sizes and styles on the EPSON MX (with GRAFTRAX), RX and FX Printers, and their compatibles (like Star and Smith Corona). 416 different faces, sizes and styles on the EPSON LQ-1500.

There's nothing to learn. Just call up the menu, push a typing key, and the printer is set to the face you've chosen.

From Word Processing to Spreadsheets, FACELIFT® will give you lots of the things you bought your printer for.



GET YOUR PRINTER'S WORTH.

Please Send Me a FACELIFT!

Here's my \$29.95 Plus \$2.50 POSTAGE & HANDLING (\$32.45 TOTAL)

(California Residents add 6.5% Sales Tax)

CALL 1-800-628-0304 CA 1-800-423-7907

Name _____

Address _____ Tel () _____

City _____ State _____ Zip _____

Signature _____ Date _____

Acct # _____ M.C. Interbank # _____ Exp. Date _____

Specify Computer Make and Model _____

FACELIFT, P.O. BOX 4339, WHITTIER, CA 90607

MasterCard

Visa

Check, M.O.

(Make payable to Companion Software, Inc.)

IC

Circle 95 on Reader Service Card.

59

by Jim Sather

The Apple Clinic is a forum for discussing Apple II hardware and related subjects. If you have questions or answers, or want to make a statement, write to Jim Sather, Apple Clinic, inCider, 80 Pine Street, Peterborough, NH 03458.

VisiTrend/Plot Revisited

Your May 1985 column contained a letter from a reader who had problems using VisiTrend/Plot with an Epson MX-100 printer. I also have an Apple II Plus with an MX-100 and have been successfully printing VisiTrend/Plot-generated graphs since 1981. The most effective solution I've found is to save the graph to disk as a binary file using the PIX SAVE option, then exit VisiTrend/Plot and run Data Transforms' Graftrix program. This program gives me three magnifications, optional cropping of the graph from the top and bottom, and normal or inverse printing.

The Graphtrix disk contains an all-purpose utility screen-dump program you can copy to any disk and call in an Applesoft program—a feature I've used extensively. The program primarily centers around adding embedded graphics to Apple Writer, but I cannot comment on this since I don't use Apple Writer.

The Graphtrix program seems more flexible and probably more economical than a hardware solution.

Eugene Shively
Albany, IN

It certainly is more economical than buying new hardware, but I still find "picture-taking" printer interface cards an attractive way to get printer dumps generated by any software anytime.

William Bull's letter resulted in a number of responses from people suggesting that VisiTrend/Plot graphics dumps are best attained by saving

the image to disk, then using a separate utility to dump the disk file to printer. Another satisfied Graphtrix user is J.E. Yamauchi. Robert E. Townsend uses Zoom Grafix by Phoenix Software to generate his dumps after saving via PIX SAVE. An additional graphics dumping utility, Roger Wagner Publishing's Printographer, has a variety of capabilities.

James C. Yule chipped in that printer interface cards with on-board graphics-dumping firmware, such as the Grappler from Orange Micro, make it much easier to get graphics dumps. He saves his VisiTrend/Plot pictures using PIX SAVE, then uses built-in Grappler features to get his printer dumps. Yule also writes that PFS:graph is perhaps superior to VisiTrend/Plot because it has driver

*routines for Epson printers and Grappler interface cards. While glancing through my own Grappler Plus manual, however, I noticed a patch that makes VisiTrend/Plot work with the Grappler Plus (see the accompanying **Figure**). I recommend that you use a protection-busting copy program to back up your VisiTrend/Plot disk and make the patch to the duplicate disk. It's never safe to attempt to patch your master copy of any program.*

CP/M or Z-80?

Please tell me the difference between a CP/M card and a Z-80 card.

Randy Leary
Meriden, CT

Figure. The VisiPlot patch for the Grappler Plus interface (reprinted with permission of Orange Micro).

A) With DOS 3.3 operating, catalog your VisiPlot or VisiTrend/Plot disk. If your disk contains the file VISILOT.DRIVER, proceed to step C.

B) If your disk does *not* contain VISILOT.DRIVER, type "RENAME SILENTYPE.D, VISILOT.DRIVER" and press the return key.

C) Enter the following Applesoft program:

```
5 A$ = "VISILOT.DRIVER"
6 B$ = "SILENTYPE.D"
7 C$ = ""
10 DATA 169,137,32,237,253,169,199,32,237,253,169,141,32,237,
    253,96
20 D$ = CHR$(4)
30 PRINT D$;"BLOAD";A$
40 PRINT D$;"RENAME";A$;C$;B$
50 FOR A = 39129 TO 39144
60 READ B
70 POKE A,B
80 NEXT
90 PRINT D$;"BSAVE";A$;"A$98C3,L$81"
```

D) Double-check the program for typing errors, then type RUN.
E) When the program stops running, your disk is configured for use with the Grappler Plus. Now boot the disk and print away.

They're the same. CP/M (control program for microcomputers) is a program—more specifically, a standardized operating system available for several microprocessors descended from the Intel 8080, including the Z-80. There is no version of CP/M written for the 6502 or 65C02, the microprocessors Apple II computers use. As a result, the basic Apple II cannot run any of the multitude of available CP/M-based programs. Instead, you must install a peripheral or auxiliary slot card containing a microprocessor that will run CP/M. The Z-80 card is by far the most popular processor card for Apples, and several versions are available. Since the reason for installing a Z-80 card in an Apple is to run CP/M, you'll often hear a Z-80 card referred to as a CP/M card.

More sophisticated Z-80 cards, such as the Microsoft Softcard, come packaged with software that includes a CP/M master disk with standard CP/M utilities. Cheaper versions often come with no software, leaving you to your own devices for obtaining general-purpose CP/M utilities disks to go along with any CP/M-based software you decide to purchase.

80-Column Display Mapping

I have an Apple 80-column text card. I'd like to be able to POKE in and read out the values of the characters on screen in the 80-column mode. I can do this in 40-column mode using memory locations 1024-2039 (\$400-\$7F7), but in the 80-column mode, these memory locations represent every other column. What are the memory locations for the missing columns?

Nur Touba
Mound, MN

They are the same, Nur, except they are in auxiliary-card memory. If the columns are numbered 0-79, then the even columns are mapped into auxiliary-card RAM, and the odd columns are mapped into mother-

board RAM. For example, the map locations for the top line of text are \$400 auxiliary, \$400 motherboard, \$401 auxiliary, \$401 motherboard, \$402 auxiliary, and so on. Double-resolution hi-res graphics is mapped similarly, but in seven-dot groups. The first seven-dot group at the top left of the screen is mapped at \$2000 auxiliary, the next at \$2000 motherboard, then \$2001 auxiliary, \$2001 motherboard, and so on.

To access the 80-column memory map, set the 80STORE soft switch (POKE - 16383,0 or STA \$C001). From that point, the PAGE1/PAGE2 soft switch alternates MPU access between motherboard and auxiliary-card memory in the \$400-\$7FF range. If the HIRES and 80STORE soft switches are both set, then PAGE1/PAGE2 selects between motherboard and auxiliary-card access in both the \$400-\$7FF and \$2000-\$3FFF ranges. See the accompanying Program listing for an illustrative BASIC program that transfers the character at the top left 80-column text position (column 0) to the adjacent position (column 1).

Voltage Regulators Overseas

In the April 1985 Apple Clinic, Oliver Hui presented three alternatives for using 110-volt Apples in countries with 240 volts, 50 cycles as standard household supply. I would just like to add a few words on this subject.

In many cases, it may not be enough simply to add a transformer. Overvoltages and undervoltages of high magnitude (20 to 25 percent) from the standard 220/240 volts are common to developing countries. Without an automatic voltage regulator between the supply line and the 240/110-volt transformer, system burnout is possible because of too low or too high a supply voltage. Motorized devices such as drive motors and cooling fans are especially sensitive to low voltages. A 220/240-volt voltage regulator can smooth 240 volts \pm 25

Program listing. Direct mapping of Apple IIe and IIc 80-column text.

```
10 STR80 = -16383 : MBD = -16300 : AUX = -16299
20 POKE STR80,0 : POKE AUX,0 : ASKII = PEEK (1024)
30 POKE MBD,0 : POKE 1024,ASKII
40 GOTO 40 : REM PREVENT SCROLL
```

Davidson is #1, #1, #1, & #1 in Education

For math, speed reading, spelling and vocabulary. Davidson's award winning software outsells all others. Why? Because enough people choose to buy the educational software that works.

MATH BLASTER makes it more fun to add, subtract, multiply, divide, and learn fractions, decimals and percents. First through sixth graders master 600 math facts with exciting graphics, animation, sound effects...even an arcade game. Apple™, Macintosh™, IBM™, Commodore 64/128™, Atari™. 49.95.



SPEED READER II can quadruple your reading speed and improve your comprehension. Develop good reading habits, chart your progress, and have fun! For high school age through adult. Apple II™, Macintosh™, IBM™, Commodore 64/128™. 69.95



WORD ATTACK lets students ten through adult discover the meanings and usages of 675 new words. Includes a fun, fast-action arcade game and add-your-own-words editor. Apple™, IBM™, Commodore 64/128™, Atari™. 49.95



SPELL IT teaches ten year olds and older how to spell a thousand and one of our most commonly misspelled words. Vivid graphics, animation, sound effects, a lively arcade game and add-your-own-words editor, too! Apple™, IBM™, Commodore 64/128™, Atari™. 49.95



Davidson & Associates, Inc.

800-556-6141

(In Calif., 213-534-4070)

Circle 19 on Reader Service Card.

Davidson.

Davidson & Associates, Inc.

3135 Kashiwa St. / Torrance, CA 90505

Please send me a FREE COLOR BROCHURE and the name of my nearest Davidson Dealer.

Name _____

Address _____

City _____ State _____ Zip _____

Educational Software that Works



6 MHz CP/M[®]

REPORT STAR[™]

WORDSTAR[®]

only

MAILMERGE[™]

STARINDEX[™]

\$299

DATA STAR[™]

SPELL STAR[™]

Delivered to your door.

CALCSTAR[®]

You made a wise choice when you bought your Apple computer. Now, you can make another smart buy—join the millions of happy users who are running thousands of CP/M programs. Hundreds of these programs are public domain...FREE of charge to you!

The Software

WordStar is a truly professional word processing system with more work-saving features than any other word processing software. It takes the time and drudgery out of revising and retyping! Features like column move and horizontal scrolling make tabular formats simple. And as your needs grow, *WordStar* will grow along with you:

Mailmerge...makes mailing labels and form letters quick and easy; *SpellStar*...allows for easy spelling checking and eliminates laborious proofreading. *StarIndex*...creates a table of contents and an alphabetical index.

WordStar comes complete with an easy-to-understand user's manual, training guide, reference card, and keypad labels.

InfoStar, made up of both *DataStar* and *ReportStar*, is one of the most advanced data base management systems available for the Apple. *InfoStar* doesn't expect you to write in code, it simply asks you what you want to do by listing a number of choices—all in plain English! *InfoStar* can turn your Apple into an order entry system, electronic filing system, or an information report writer. Plus, it works together with *WordStar* and *CalcStar* (the electronic spreadsheet program) so you can create complete business reports!

The Hardware

StarCard is a printed circuit board with Z-80B microprocessor. It runs at 6MHz (3 times faster than the Apple microprocessor) and has its own 64K of RAM. *StarCard* does not use the Apple's memory for program exe-

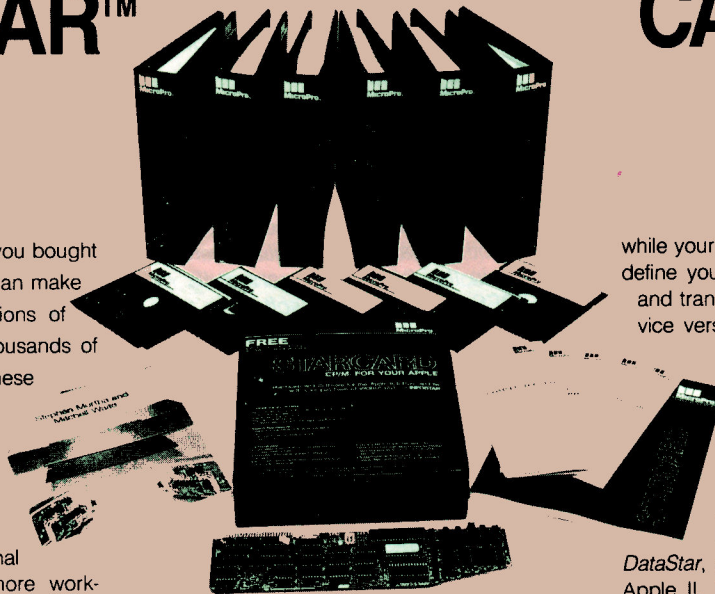

while your file is being printed! You can even define your own functions for different keys and transfer Apple DOS files to CP/M...or vice versa.

Technical Data

6MHz Z-80B Processor
64K RAM on Board
57K RAM Transient Program Area
Requires: 80-column board for *DataStar*, *ReportStar*.
Apple II, II Plus or IIe with 48K RAM, two disk drives with Apple DOS 3.3.

cution.

StarCard works only in the Apple II, II Plus, and IIe (pre-installed for the Apple IIe or II Plus). *StarCard* will also use the Apple's graphics ability to produce a 70-column screen if you don't have an 80-column card.

You *must* have an 80-column card to use *DataStar* or *ReportStar*. *WordStar*, however, can run in 70. We will be happy to supply you with an 80-column card for only \$39.95, shipping included. Please ask for it.

Run Apple DOS or CP/M

If you boot with an Apple DOS disk, your Apple will run under Apple DOS. If you boot with the *StarCard*'s CP/M disk, your Apple will run under CP/M. You don't have to remove the *StarCard*...you can also use the 64K RAM on the *StarCard* as a disk drive when you're using Apple DOS. Since the normal Apple drives are only 141K, this capability furnishes you with approximately half of a disk drive.

Full CP/M System

StarCard uses the standard CP/M 2.2 and has all the usual CP/M utilities.

SYSGEN and FORMAT have been combined into a special utility called COPYFRMT to make them easier to use.

The CP/M utility MOVCPM is contained in the INSTALL utility. Use the Apple RAM as a printer buffer so you can continue working

Tremendous Savings

You get so much for your money! The manufacturer's suggested retail price is over \$1,600 and even the best mail-order prices have been over \$800.

Act now and it's yours for just \$299, delivered to your door! Satisfaction guaranteed or your money back.

14 Day Free Trial

Use this package for two weeks, and then if you wish to return the merchandise, your money will be cheerfully refunded. We'll pay the return shipping charges, too!

**ORDER NOW! CALL
TOLL FREE:**

**1-800-527-3582 USA
1-800-442-1310 Texas**

**Total Access
PO Box 764246
Redbird Airport,
Hangar #8
Dallas, TX 75376-4246
(214) 337-4346**

percent at its input to 240 volts \pm 10 percent at its output. The output of the regulator is then connected to a 240/110-volt transformer.

You were right in suggesting that transformers are available overseas. An alternative, however, for those who don't have the patience to hunt around or who are going abroad on a short visit is to buy the transformer and the matching voltage regulators of different capacities in the United States from Computers Plus Company, 2303 North 44th Street, Phoenix, AZ 85008, (602) 955-1404.

Vasant L. Abhyanker
President
Computers Plus Company
Phoenix, AZ

Thanks for the tip, Vasant. It certainly is possible that large voltage variations can occur in many locations and that a line regulator is necessary. Experienced travelers know they cannot take stable power and other dependable utilities for granted in all parts of the world. I would make sure I was aware of the dire possibilities, but wouldn't purchase a line-voltage regulator until I had a good reason to suspect I needed one.

Taxan RGB Interface

I'm having trouble displaying Apple //e double hi-res graphics on my Taxan Vision III Model 410 RGB monitor. I've tried the Taxan 410-80, 410-08, and 410-64 interface cards with no luck. Taxan customer service informed me I need the 410-64 card, but it supports double hi-res in only two colors—black and the color selected on the interface card. The card does work with my Beagle Bros Diskquik software. Is there any way to generate double hi-res graphics with 16 colors on the Taxan RGB Vision III Model 410?

George A. Kerekes
Baton Rouge, LA

I showed your letter to the technical-support group at Video-7, the company that designed the Taxan RGB cards as well as Amdek, Princeton Graphics, Sakata, Panasonic, Apple, and Sony cards. Apparently the Taxan 410-64 is an older design that doesn't support double-resolution hi-res except in monochrome graphics. Off the top of his head, my contact at Video-7 named the Amdek, Apple, and Sony cards as examples of RGB

cards that do support 140-point double-resolution hi-res graphics in 16 colors.

The cards Video-7 sells under its own name also support double hi-res colors. These cards—the V-color //e for the Apple //e auxiliary slot, V-color //c for the Apple //c, and V-color 7 for the Apple II or //e slot 7—all produce displays of the quality of the V-color //c reviewed in inCider (December 1984, p. 150). The V-color //e also includes the 64K RAM and 80-column functions.

Expandable RGB Interface

I own an enhanced Apple //e with an Amdek Color II Plus monitor. I'm trying to upgrade to 128K and beyond, but am told that my Amdek RGB card is not expandable. After numerous phone calls and visits to my local Apple dealer, I turn to your column and sage advice on how I can best accomplish my task.

Frank C. Gavin
Ft. Leavenworth, KS

One option is to keep your RGB card and find a peripheral-slot RAM card that meets your expansion needs, perhaps a Titan Technologies' 192K Neptune board (for the //e only). Another option is to purchase an auxiliary card that combines the RGB interface and high-capacity RAM-expansion functions. Applied Engineering's RAMWORKS card is expandable to 1 megabyte and has optional RGB interface. Also, Checkmate Technology is developing an RGB/RAM card that's expandable to 512K. The company hasn't even named it yet, but it should be released by the time this issue hits the stands.

I'm sure you can find other options if you shop around. The expansion RAM card business is competitive, and there are many products from which to choose.

More RGB

I currently own an Apple II Plus equipped with one disk drive, 16K RAM card, Epson MX-80 printer, and Super Fan. I recently acquired a Sylvania RGB monitor/receiver, model RAD139SL. Although I now feed my output through a modulator to the TV input, I'd like to start using the RGB capability of the monitor for 80-column resolution. If possible, please

Continued on p. 66.

Diversi-DOS™ Still The Best!

The top-rated DOS 3.3 enhancement program. Lots of extras! DOS Mover frees up 10K memory. Includes new insert/delete mode, improved BASIC listings, keyboard MACROS, wildcard filenames, text file printer, keyboard/print buffers, **fast garbage collection**, and MORE! Works on Apple //c, //e, or 64K II+.

RAM Disk Emulator Now Included

Use the extra 64K in the //c or //e extended 80-column card as a high-speed pseudo-disk drive. Also works with most 128K cards in slot 1-7.

Time in Seconds	DOS 3.3		Diversi-DOS	
	Floppy	Floppy	Floppy	RAM-disk
BSAVE*	13.6	4.1	0.6	
BLOAD*	9.5	2.6	0.5	
WRITE**	44.6	14.9	7.7	
READ**	42.2	12.4	5.5	

*Hi-res screen **52-sector text file

Back-up Your Floppy with Diversi-Copy™

The **FASTEST way to copy** (or format) unprotected DOS 3.3, ProDOS, Pascal or CP/M disks.

Great for Apple //c! Saves over 2 minutes per copy, and eliminates those annoying disk re-insertions.

Verifies every byte, so you know your copies are good.

Shows motor speed on each track, eliminating a major source of errors.

Mass produces 1 copy every 18-20 seconds (may require extra 128K).

Works on all Apple II compatibles.

	ProDOS Copy	Diversi-Copy*
1-Drive Copy (50% Full Disk)	172 sec. 18 insertions	36 sec. 2 insertions
1-Drive Copy (100% Full Disk)	172 sec. 18 insertions	44 sec. 4 insertions
2-Drive Copy	80 sec.	33 sec.

*On 128K Apple //e or //c

NEW: Diversi-DIAL™

Start your own CB-simulator on an Apple with 7-modems. New profit-making local stations starting all the time. Call 815/633-6533 (300-baud).

24-Hour Toll-Free Ordering

800/835-2246 ext. 127 (orders only).

For information call 313/553-4466

Disk normally shipped within 24

hours. Price includes 1st class or

foreign airmail. Return in 30 days

for full refund if not totally satisfied

FREE: Dogfight II arcade game, by Bill Basham, included with each disk.

Diversi-DOS - \$30

Diversi-Copy - \$30

dsr

DIVERSIFIED SOFTWARE RESEARCH, INC.

34880 Bunker Hill

Farmington, MI 48018-2728

Visa/Mastercard/C.O.D./Personal Check accepted

Card No. _____ Exp. _____

The Sequel to an Exciting Software Premiere...

hotCider VOLUME II

More Of The Very Best Ready-to-run Apple II* Programs From inCider

Coming in October... a second incredible collection of *inCider* magazine's best programs. **hotCider Vol. II!**

Get a dozen ready-to-run programs for the Apple II on a high-quality, menu driven floppy disk. Programs for business, home management, education, entertainment, and graphics! No tedious typing or debugging to worry about! And it comes complete with its own documentation booklet.

What A Menu!

Just like the exciting Vol. I, *hotCider Vol. II* is loaded with all-time *inCider* favorites:

"Should I Trade?"—Tells you the Real cost of buying a new car.

"Low-Res to Hi-Res"—Shows you how to easily convert your lo-res pictures to hi-res.

"Modem Battleship"—Dial up a friend and use your modem to play this latest version of Battleship.

Plus, more utilities, games, and educational programs!

Vol. I— Still Available!

If you haven't ordered your *Volume I* yet, the premiere issue of *hotCider* is still available in limited quantities!

Enjoy such standouts as;

"VisiData"—A list handler that works like a spreadsheet.

"Poster Printer"—Say anything in a BIG way with your printer.

"Doing Windows"—Learn how to create Macintosh-style windows on your Apple II.

hotCider Vol. I also gives you three previously unpublished *bonus programs*, including "Cider Zap" (a full-fledged editing utility)!

Easy To Use, Easy To Order

There's no easier way to build a versatile software library than with *hotCider Vol. I and Vol. II*. To order your copies, return the coupon or attached card, or call **1-800-258-5473**. In NH, dial 1-924-9471.

YES! I want the very best ready-to-run programs from inCider.

Send me hotCider on disk for \$21.47**.

- hotCider Vol. II hotCider Vol. I
 Payment enclosed AE Visa MC

Card # _____ Exp. date _____

Signature _____

Name _____

Address _____

City _____ State _____ Zip _____

* Apple and the Apple logo are registered trademarks of Apple Computer, Inc.
 ** Prices include postage and handling. Foreign airmail please add \$1.50 per item.
 US funds drawn on US banks only. 10-85C

hotCider • 80 Pine Street • Peterborough, NH • 03458

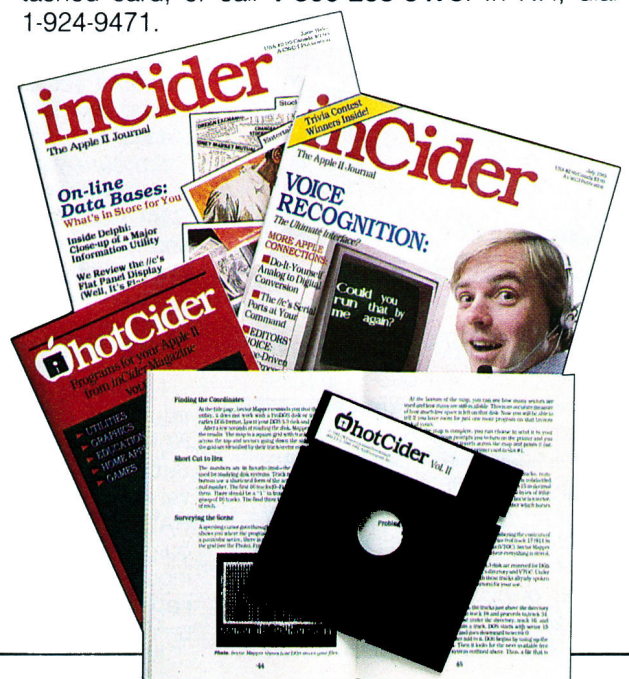

Back Up Your Software

E.D.D. III	45.00
CIA Files	48.00
Copy II Plus—Central Point	21.00
Locksmith 5.0—Omega	65.00
Nibbles Away III	21.00
Copy Master II 128K w/Gr Dump	99.00
Wildcard II—Central Point	79.00
Replay II—MicroAnalyst	79.00

Entertainment

Adventure Construction Set	34.00
7 Cities of Gold or Skyfox	26.00
Murder on the Zimderneuf	26.00
Archon II or One-On-One	26.00
Pinball Construction Set	23.00
Micro League Baseball	24.00
Gato	24.00
Ghost Busters or Pitfall II	24.00
Tracer Squadron or Mind Shadow	24.00
Miner 2049er or The Heist	24.00
Wizardry	30.00
Knight Of Diamonds	21.00
Legacy of Lyligamyn	24.00
Return Of Werdna	24.00
Rescue Raiders	22.00
Wispsint	16.00
Super Zaxxon or Frogger 3 Deep	25.00
The Quest or Ring Quest	21.00
Expedition Amazon, or Xyphus	21.00
Sword of Kadsah	21.00
Below The Root	20.00
Swiss Family Robinson	20.00
Millionaire, Tycoon, or Barron	25.00
Solo Flight or Nato Commander	22.00
Amigo or Dragon World	25.00
Fahrenheit 451 or Shadow Keep	25.00
Flight Simulator II	35.00
Championship Lode Runner	21.00
Choplifted or Karateka	21.00
Pole Position or Zaxxon	20.00
Wizard of Id, Conan, or Mr. Do	24.00
Spy Hunter, Star Trek, or Tapper	27.00
Murder By The Dozen or Felony	25.00
Kings Quest	30.00
Beyond Castle Wolfenstein	20.00
Ultima III: Exodus	34.00
Sargon III	31.00
Cuthroats, or Seastalker	24.00
Hitchhiker's Guide to The Galaxy	23.00
Deadline, or Starcross	29.00
Witness, Planefall, or Enchanter	24.00
Inferno or Sorcerer	24.00
Zork II, Zork III, or Suspect	27.00
Zork I	24.00
Operation Market Garden	35.00
Objective Kursk or Phantasia	24.00
War In Russia	48.00
30 Mission Crush or Broadside	32.00
Kampfgruppe or Reforger 88	36.00
Imperium Galactum	24.00
Germany 1985 or Carrier Force	36.00
Baltic BS or Gemstone Warrior	21.00
Geopolitique 1990 or Rats West	24.00
North Atlantic '86	36.00
Battle For Normandy	24.00

Utility Software

Apple Mechanic	17.00
Beagle Basic	20.00
Beagle G.P.T.E.	28.00
Beagle Graphics	23.00
D-Code	23.00
Disk Quick	17.00
Dos Bos	14.00
Double Take	20.00
Extra K	20.00
Fat Cat	23.00
Flex Text	17.00
Frame Up	17.00
I.O. Silver	17.00
Pro-Byter	20.00
Pro-Dos	17.00
Silicon Salad	14.00
Triple Dump	23.00
Typefaces	11.00
Utility City	17.00
Bag of Tricks	25.00
Applesoft Compiler (Microsoft)	109.00
Einstein Compiler	45.00
Lisa V2.6	54.00
Merlin Pro	59.00
Merlin Assembler	37.00
Merlin Combo Pack	65.00
Turbo Pascal 3.0	39.00
Turbo Tool Box	33.00
Visible Computer: 6502	32.00
The Graphics Magician	36.00
New Complete Graphics Sys.	49.00
Dazzle Draw	37.00
Pix-It	30.00
Blazing Paddles	30.00
Zoom Graphics	31.00
Sideways	38.00
Fontry 1.5	55.00
Font Paks 1-13 ea.	12.00
AppleWorks Modifier 64K	39.00
AppleWorks Modifier 128K	49.00

Blank Media

Elephant SS/DD (10)	12.50
Maxell SS/DD (10)	15.50
Verbatim SS/DD (10)	16.50
BA5F SS/DD (10)	14.95
Memorex SS/DD (10)	14.95
3M SS/DD (10)	17.95
Dysan SS/DD (10)	22.95

Business Software

Apple Access I / (/ / / / c)	59.00
Apple Works	189.00
Apple Writer I / (/ / / / c)	119.00
Quickfile I / (/ / / c)	75.00
Advanced Logic Systems	
List Handler (I + / / / / c)	45.00
The Handlers (I + / / / / c)	99.00
Word Handler II (I + / / / / c)	45.00
Applied Software Technology	
Versalrom	45.00

Artac MagiCalc	89.00
Magic Office System	129.00
Magic Window II	79.00

BPI Systems

General Accounting Dos 3.3	229.00
AR, AP, PP or Inv. Dos 3.3 (ea.)	229.00
General Accounting ProDos	229.00
AR/AP/PP or Inv. ProDos (ea.)	229.00

Continental Software

F.C.M./F.L.	59.00
G.L., A.R., A.P. Payroll ea.	135.00
Home Cataloger	30.00

Creative Peripherals

Time Trax / Ie or / Ic Version	79.00
Time Trax / Ic System Clock Only	55.00

Dow Jones Software

Investor's Workshop	89.00
The Market Analyzer	199.00
The Market Microscope	199.00
Dow Jones Membership Kit	19.00

Hayden Pie Writer V2.2

92.00

Human Edge Software

Communications Edge	89.00
Management Edge	89.00
Mind Prober	30.00
Sales Edge	89.00

Kensington Microware

Format II Enhanced	89.00
--------------------	-------

Living Videotext

Think Tank II + or / Ie	79.00
-------------------------	-------

MegaHaus MegaFinder

MegaSpells	35.00
MegaWorks	75.00
MegaWriter	64.00

Micropro Calstar

Infostar w/Z-Card	120.00
Wordstar w/Z-Card	169.00
Wordstar Pro w/Z-Card	228.00

Microsoft

Microsoft Software w/Basic II	315.00
Multiplex (Apple Dos Version)	59.00
Microsoft Crosstalk	105.00

Organizational Software

Omnia 2	159.00
Omnia 3	229.00

PBI Software Graphworks 1.2C

Jeeves	39.00
--------	-------

Practico

Back To Basics Accounting	109.00
Practico Practical II	31.00

Precision Software SuperBase

Quark Catalyst / Ie	95.00
Terminus / Ie	55.00
Word Jumper / Lexicheck / Ie	115.00

Roger Wagner Publishing

Wise Write	89.00
------------	-------

Sensible Software Bookends

North Atlantic '86	72.00
The Sensible Speller	72.00

Sierra On-Line

General Manager II	129.00
Screenwriter Professional	78.00
Software Arts TKI Solver	169.00
The VisiCalc Package	99.00

Software Publishing

PFS Best Sellers	145.00
PFS:File	72.00
PFS:Graph	72.00
PFS:Report	72.00
PFS:Write (/ Ie, / Ic)	72.00
PFS:Access (/ Ie, / Ic)	43.00
Sorcim/ImUS SuperCalc 3a	109.00
Stoneware	
DB Master Business Team	189.00
DB Master Business Writer	89.00
DB Master Verso Four Plus	169.00
Visicorp/Paladin	
Flashcalc II + / Ie, / Ic	59.00
VisiSchedule	89.00

Educational Software

Apple	
Apple Logo I / 128K (/ Ie, / Ic only)	79.00
Baron's Computer SAT	53.00
CBS Software Adventure Master	27.00
America Coast to Coast	25.00
Dinosaur Dig	25.00
Forecast or T-Rex	30.00
Goren's Bridge	49.00
Mastering The SAT	59.00
Micro Speed Reading	59.00
Success w/Algebra (ea.)	22.00
Success w/Math (ea.)	15.50
Davidson & Associates	
Classmate or Math Blaster	29.00
Speed Reader II	41.00
Speed Reader Data A, B, C, or D	15.00
Spell-It or Word Attack!	29.00
Designware Body Transparent	28.00
European Nations & Locations	28.00
Remember	55.00
States & Traits	28.00
DLM Alligator Mix	20.50
Demolition Division	20.50
Freddie's Puzzles	19.00
Spelling Wiz	20.50
Harcourt Brace Computer SAT	47.00
Learning Company	
Addition Magician	21.00
Bumble Plot or Reader Rabbit	24.00
Gettrude's Puzzles	27.00
Juggle's Rainbow	18.00
Magic Spell or Word Spinner	21.00
Robot Odyssey or Rocky's Boots	30.00
MECC All Titles in Stock	Call
PECS: Algebra 1, 2, 3, or 4	22.50
Algebra 5 or 6	27.50
Compu-Read	17.00
Compu-Math: Arithmetic Skills	29.00
Introduction to Computing	25.00
PSAT or SAT Word Attack Skills	18.00

PSAT/SAT Analogy	18.00
Spelling Bee w/Reading Primer	23.00

Scarborough Systems

Masterbyte's Writing Wizard	49.00
Build A Book About You	25.00
Original Boston Computer Diet	49.00
Run for the Money or SongWriter	24.00

Scholastic Wizards

Agent U.S.A. or Turtle Tracks	24.00
Operation: Frog or Logic Builders	24.00
Logo Robot or Kids at Work	19.00

Simon & Schuster

JK Lasser Money Manager	59.00
-------------------------	-------

Spinlaser

Adventure Creator or Trains	21.00
Aerobics or Snopcor Troops	22.00
Counting Parade	21.00
Delta Drawing	28.00
File & Report or Spreadsheet	38.00
Fraction Fever	16.00
Grandma's House	16.00
In Search Of...	21.00
Kidwriter	19.00
Kindercomp or Kids on Keys	16.00
Treasure Island or Wizard of Oz	19.00
Word Processor	38.00

Springboard

Early Games or Music Maestro	21.00
Fraction Factory or Make a Match	19.00
Rainbow Painter or Puzzle Master	21.00
Newsroom Clip Art Collection	18.00

Sunburst

Challenge Math or The Factory	30.00
Teasers by Tobbe	30.00
The Incredible Laboratory	30.00

Terrapin Terrapin Logo

59.00

Xerox Chivalry

Exploring Tables & Graphs 1 or 2	23.00
Pic Builder	24.00
Stickybear Series (ea.)	24.00

Modems

Anchor Mark XII Standalone	235.00
Anchor Spq-Admin Express	259.00
Apple II Baud Modem	179.00
Apple 1200 Baud Modem	379.00
ERA 2 by Microcom	289.00
Hayes Microcom / Ie	135.00
Hayes 300 Baud Smartmodem / Ic	155.00
Hayes 300 Baud Smartmodem	129.00
Hayes 1200 Baud Smartmodem	375.00
Hayes 2400 Baud Smartmodem	599.00
Novation 2400 Baud Standalone	489.00
Novation Apple Cat II	189.00
Novation 212 Apple Cat II	359.00
Popcom X100 (1200 Baud)	285.00
Pro Modem 1200 (External)	309.00
Pro Modem 1200A (Internal)	289.00
U.S. Robotics Password 1200	199.00
U.S. Robotics Password 2400	399.00
ZoomModem / Ie	119.00
ZoomModem / Ie Plus	129.00

Z80/80 Col./Ramcards

Applied Engineering: RamWorks	Call
Applied Engineering: Z-RAM / Ic	Call
Checkmate—Multiview 80160	219.00
Checkmate—Multirem Cards	285.00
Quadram Multicore Card	Call
Quadram E-Ram 80	99.00
Apricom 16K Ramcard II+	68.00
Saturn 128K Ram	179.00
Neptune 80 Col. 64K Card	185.00
Extender 64K Extender II	139.00
Extend 80 (Caribbean Computer)	79.00
Micro Sci 80/64e	69.00
Video Videoterm w/SS Inv.	178.00
Video: Ultraterm	189.00
ALS Z-Engine 2.2	129.00
Microcom Premium Softcard / Ie	259.00
Microsoft Softcard II	269.00
MTC Speed Demon	199.00
Accelerator / Ie	219.00

Interface Cards

Apple Super Serial Card	109.00
Serial Interface Card	105.00
AST Multi IO	175.00
Serial Grappler Plus	75.00
Grappler +	75.00
Buffered Grappler +	135.00
Grappler / Ic	79.00
Nice Print (Spies Labs)	125.00
Finger Print Plus	99.00
Print-It! (Parallel or Serial)	135.00
Plasko/J Interface	115.00
Video 7 RGB Interface / Ic	95.00
Video 7 64K RGB Interface / Ie	129.00

Accessories

Kensington System Saver	62.00
Cool + Time	69.00
Apple Mouse / Ie	115.00
Apple Mouse / Ic	79.00
Hayes Match II Joystick	29.00
Hayes Match III Joystick	34.00
Kraft Joystick	32.00
Gibson Light Pen	149.00
Digital Paintbrush System	175.00
Muppet Learning Keys	44.00
Koskie Pad	15.00
Key Tronic Keyboard	225.00
Trackhouse Keypad	79.00
Mockingboard A Board	74.00
Mockingboard C Board	125.00
Mockingboard D Board (/ Ic)	134.00
Echo II Plus	94.00
The Crcklet / Ic	115.00

Printers

Apple ImageWriter	459.00
ImageWriter (Wide Carriage)	549.00
LazerWriter Printer	Call
Scibe Printer	229.00
Brother HR-15XL	355.00
HR-25	489.00
HR-35	689.00
TwinWriter 5	899.00

Citizen MSP-10 (160 cps)	279.00
MSP-15 (160 cps)	379.00
MSP-20 (200 cps)	399.00
MSP-25 (200 cps)	529.00

C.toh ProWriter 8510 AP

295.00
445.00
329.00
469.00
399.00

Epson

Product Information

Graphtrix 1.2

Data Transforms
616 Washington, Suite 106
Denver, CO 80203
(303) 832-1501
\$65

Reader Service Number 300

Grappler Plus

Orange Micro
3150 East La Palma, Suite G
Anaheim, CA 92806
(714) 630-3622
\$119

Reader Service Number 301

MultiView 80/160

Checkmate Technology
509 South Rockford Drive
Tempe, AZ 85281
(602) 966-5802
\$349.95

Reader Service Number 302

Neptune

Titan Technologies
310 West Ann Street
Ann Arbor, MI 48104
(313) 662-8542
\$249

Reader Service Number 303

The Printographer

Roger Wagner Publishing
10761 Woodside Avenue, Suite E
Santee, CA 92071
(619) 562-3670
\$39.95

Reader Service Number 304

RAMWORKS

Applied Engineering
P.O. Box 798
Carrollton, TX 75006
(214) 241-6060
\$179-\$649
\$129—RGB option

Reader Service Number 305

RGB/RAM card

(available soon)
Checkmate Technology

Reader Service Number 306

Softcard //e

Microsoft Consumer Products
10700 Northup Way
Bellevue, WA 98004
(206) 828-8088
\$345

Reader Service Number 307

V-color //e

V-color //c

V-color 7

Video-7
550 Sycamore Drive
Milpitas, CA 95035
(408) 943-0101
\$180—V-color //e
\$130—V-color //c
\$150—V-color 7

Reader Service Number 308

Zoom Grafix

American Eagle Software
P.O. Box 46080
Lincolnwood, IL 60646
(312) 792-1227
\$49.95

Reader Service Number 309

Continued from p. 63

provide information on an RGB interface and 80-column card compatible with this monitor.

In addition, I'm considering increasing my computer's memory by an additional 64K. What is the best method of accomplishing this? Is it possible to implement all of this with one card?

Paul R. Childers
Upland, CA

I think you should take a serious look at the new Checkmate Technology slot 0 RAM/RGB card I mentioned in my response to the previous letter. I know of no other card that combines the RGB and RAM-expansion functions for Apple II Plus owners.

Another Checkmate Technology product I'd like to point out to Apple Clinic readers is the MultiView 80/160 text-display card, reviewed in inCider (July 1985, p. 78). This card solves Leonard Rosenthal's problem of running AppleWorks on a Franklin (or Apple II, Basis, and so on; see the March 1985 Apple Clinic). With the preboot disk Checkmate promises to have ready by October, you can have AppleWorks up and using the Checkmate or other RAM-expansion card. As noted in the review, the preboot disk also supports ProDOS Apple Writer and various spreadsheets on Apple II compatibles. Be aware, though, that the MultiView/AppleWorks combination will only result in a 10K working space for AppleWorks on a 64K Apple II or compatible. You'll need RAM expansion of some sort to get more work space for AppleWorks.

50 Hz a Problem?

I'm taking my 120-volt, 60-Hz Apple //e to the Netherlands, where household power is 220 volts, 50 Hz. I know I can get a transformer to step down the voltage, but will the 50-Hz frequency affect my disk drive and printer?

Gary Hammond
Victorville, CA

A DC motor turns the disks, and disk-head and printer-mechanism positioning is via computer-controlled stepper motors, so the line frequency should not affect disk-drive or printer operation. This is typical of most printers, but not true of most motorized typewriters. When I lived in Japan, all my computer peripherals worked great on 50 Hz, but my 60-Hz typewriter didn't work worth beans. ■

TERMEXEC

"TermExec does a lot for the money." InCider

A total communications resource, TermExec lets you talk with any other phone-accessible computer...mainframes, information services, or micro-based Bulletin Board systems.

Circle 281 on Reader Service Card.

A lot for \$95.00 with our money-back guarantee. American Express, Visa & Mastercard accepted. Write or call today for more information and our free brochure.

Quinsept, Inc.

P.O. Box 216, Dept. IC
Lexington, MA 02173 / (617) 641-2930
Bulletin Board (617) 863-0282

FASTER THAN TURBO

ZBASIC

New lightning-fast ZBASIC zaps the competition.

It's hot. It's brand-new. And light years ahead of anything else.

It's ZBASIC. Written for programmers by programmers. (If you know BASIC—you know ZBASIC!) Now you can write a program exactly the same way on an Apple, an IBM, a Tandy, or any other major micro and port the source code. You only write the program *once* ...and it runs on all the major micros. The commands stay the same—regardless of the computer* (even graphic commands and disk I/O!).

ZBASIC. Starting now, it's the only language you'll ever have to know.

*subject to hardware limitations.

The finest implementation of the BASIC language for microcomputers!

**YES N/A—Not available	ZBasic Interpreter 3.0	TURBO PASCAL 3.0	MBASIC compiler	True BASIC	BASICA Interpreter (IBM PC)
IBM and compatibles	*	*	*	*	*
Apple IIe, IIc (8502)	*	N/A	N/A	N/A	N/A
Macintosh	4th Qtr.	N/A	N/A	N/A	N/A
CP/M-80 2.2, 3.0	*	*	*	N/A	N/A
TRS-80 Mod 1, III, 4, 4p	*	N/A	*	N/A	N/A
Direct commands	*	N/A	N/A	*	*
Maximum scientific digits of accuracy. (COS, SIN, ATN, LOG, EXP etc.)	6 to 54 selectable by the user	11 Binary BCD N/A	16	16	6
Device Independent Graphics (same CMDS all graphic modes and computers)	*	N/A	N/A	N/A	N/A
SAME File commands all computers?	*	N/A	N/A	N/A	N/A
STRUCTURED: Labels, Functions, LONG IF etc.	*	*	N/A	*	N/A
Same editor commands all versions/computers	*	*	N/A	N/A	N/A
Sieve benchmark (Byte January 1983, 10 lines)	13.7 sec.	14.1 sec.	14.9 sec.	261 sec.	2190 sec.
Shell-Metzner SORT (Sydex-BASIC for Scientist's and Eng. 2,000 5 char. strings)	19 sec.	28 sec.	71 sec.	194 sec.	2700 sec.
Executable Machine Lang. & approx. File size	12k	12k	32k	N/A	N/A
PRICE with BCD BCD—No rounding errors	89.95	108.95	450.00	N/A	N/A
PRICE without BCD	89.95 BCD FREE	89.95	395.95	149.95	Comes with computer

AVAILABLE NOW!

- Works the same on all micros
- Uses same commands—regardless of computer make
- Structured Basic—(spaghetti optional)
- Device-independent graphics (same graphic commands on all computers)
- 6–54 digits of precision (selectable by user)
- Built-in interactive editor and compiler—to compile and execute, just type “run.”
- Choice of alphanumeric labels or line numbers

Not copy protected

One low price gives you everything—there are no hidden costs. Only \$89.95 complete.

ZBASIC™

The lightning-fast BASIC from Zedcor

To order use this coupon or call
1-800-453-4100

Utah Residents 1-800-662-8666; Alaska Residents 1-800-982-1500

Mail to: ZEDCOR
3438 N. Country Club Road / Tucson, AZ 85716

(Name) _____

(Address) _____

(Apt.) _____

(City) _____

(State) _____

(Zip) _____

(Day Phone) _____

CREDIT CARD—MASTERCARD/VISA/AMEX C.O.D.

EXPIRATION DATE: _____

ZBASIC is a trademark of ZEDCOR, Inc. © 1985 IBM is a registered trademark of International Business Machines Corp. Apple II, IIc and Macintosh are trademarks of Apple Corp. Inc. Microsoft is a registered trademark of Microsoft Corp. TURBO PASCAL is a registered trademark of Borland Inc. MBASIC is a registered trademark of Microsoft Corp. True BASIC is a trademark of Ashton-Tate Publishing Co. BASICA is a registered trademark of International Business Machines Corp.

All trademarks and associated apps in this ad are the property of their respective owners. Other trademarks and/or registered trademarks are the property of their respective owners. All other trademarks are the property of their respective owners. All other trademarks are the property of their respective owners.

ZBASIC IBM PC/Compatible (128K, MS DOS 2.0 or better recommended) \$89.95 \$ _____

ZBASIC Apple IIe, IIc (128K, Dos 3.3) \$89.95 \$ _____

ZBASIC CP/M-80 (Z-80—2.2 or 3.0) \$89.95 \$ _____
(Provided on 5 1/4" KAYPRO II-SSDD Format)

ZBASIC TRS-80 (48K) \$89.95 \$ _____
(Circle Model 1.3 or 4—6.2)

ZBASIC Macintosh (Delivery 4th quarter) \$89.95 \$ _____

DEVELOPERS—BUY ALL 5, SAVE \$50. \$449.75 VALUE \$399.75 \$ _____

Arizona Residents Add 5% Sales Tax \$ _____

SHIPPING: U.S. add \$5.00 per program \$ _____

Foreign or C.O.D. add \$10.00 per program (U.S. currency only) \$ _____

TOTAL \$ _____

Beneath Applesoft: The First Step

Unravel the mysteries of assembly-language programming.

by Roger Wagner

Welcome to the first installment of Right of Assembly, *inCider's* newest column, dedicated to helping you learn about assembly- and machine-language programming. This skill can bring out the power in your Apple, and, best of all, it's surprisingly easy to learn.

Each month, I'll examine various machine-language commands and present working examples of what those commands can do. If you're new to the subject, you'll find each column teaches you things you can use immediately in your own programs—often even within Applesoft programs. And, if you already program in machine language, you'll discover new tricks of the trade. In either case, I'm sure you'll find Right of Assembly a valuable reference you'll want to keep around as an ever-growing resource.

A World of Languages

You create a program by putting possible commands in a certain meaningful order to tell the computer how to do a certain task. *Programming* itself describes the process of telling your computer what you want it to do. In fact, this is the real power of the computer as a modern device: You can tell it how to help you solve problems that are unique to your life—on your own terms and at your convenience.

Programming a computer isn't as hard as you might think. The only requirement is a language with which you can communicate with your computer, since the computer doesn't understand English directly. (See "Digital Dialects: A Guide to Apple Languages," August 1985, p. 14.) But it's not always necessary to use BASIC, Pascal, or another formal computer language. Some of the most successful commercial programs for the com-

puter are just well-disguised programming languages. As an example, consider the classic spreadsheet program. It's always fun to hear someone say, "Oh, I don't program. I just use programs like the Acme Spreadsheet." With a little thought, you realize that using a spreadsheet is a lot like programming; it's just a different method of programming. You create a set of numbers, variables, and equations the computer uses in a predictable order. Some of the more advanced spreadsheet programs have enhancements like search and sort functions, condition testing (IF... THEN), and more.

How It Really Works

Lesson 1 in machine-language programming starts with Wagner's Paradox: "Everything complex can be broken down into simple elements (and nothing is as simple as it seems)."

Although you may sometimes feel that life is an endless case of discovering the fine print, it's true that most things in life are quite simple when you consider the fundamentals that make them up. The computer is an excellent example.

Even though the engineering required to build a computer is awe-inspiring, the underlying principle of its operation is almost trivial. The heart of your Apple is the 6502 microprocessor (65C02 in the //c and enhanced //e). The other important ingredient is the computer's "memory"—thousands of locations (called *bytes*) where the computer stores simple numbers.

A microprocessor scans memory, one location at a time, and performs one of about 50 general operations, depending on the number it finds in a particular memory location. The number 27 in a certain location, for instance, may tell the microprocessor to add numbers; a 32 may indicate subtraction.

Obviously, the more memory a computer has available, the greater the

number of instructions (and the more information to work on) it can hold. The 6502 in an Apple can directly address about 64,000 memory locations, 64K. There are ways of putting more memory into the computer, but the 6502 still talks to only 64K at a given time. (Even though there are actually 65,536 locations in the computer, the number is traditionally rounded to an even 64,000. "K" is used as an abbreviation for thousand, for the really lazy.)

BASIC Versus Machine Language

Machine language consists of numbers in memory on which the microprocessor can act directly, without any translation. Machine-language programming in its literal sense is the process of placing those numbers in memory, one at a time, to create a program the computer can carry out. Assembly language, as you'll see in upcoming months, is a very close relative of machine language.

BASIC is a "high-level language." One way of looking at this term is to consider that the 100 or so BASIC commands (like PRINT) are closer to English than those of the more simplistic low-level languages, like machine language. What it really means, though, is that, transparent to the user, a new command has been created from the 50 fundamental machine-language commands, to perform some fairly complex task. An interesting analogy might be to consider that the basic 26 letters of the alphabet create all the words you know.

In its "native" mode—the 6502 and some memory—the computer doesn't automatically understand words like PRINT or RUN. When you type in RUN to start an Applesoft program, you are actually triggering in the computer a machine-language program that acts as a middleman between the lines of BASIC you typed in and those 50 commands the 6502 understands.

NORTH EASTERN

88 Ryders Lane, Stratford, Connecticut 06497

Software

For the APPLE:

- WE WILL TRY TO MATCH AND BEAT ANY ADVERTISED PRICE
- SCHOOL AND CORPORATE PURCHASE ORDERS ACCEPTED
- CALL ABOUT OUR FREQUENT PURCHASER PROGRAM AND SOFTWARE RENTAL LIBRARY

ENTERTAINMENT	
Spy Hunter or Buck Rogers	26.75
Tapper or Star Trek	26.75
Frogger 3-Deep or Super Zaxxon	22.00
Sorcerer or Suspect or Infidel	26.75
Cuthroats or Zork I	23.75
Zork II or Zork III	26.00
Witness or Seastalker	23.75
Deadline, Suspended, Starcross	28.75
Plonewolf or Enchanter	23.75
Hitchhiker's Guide	23.75
Murder by the Dozen or Felony	23.00
Ultima III	33.75
Lode Runner or Karetaka	21.75
Championship Lode Runner	20.75
Choplifter	20.75
Relfinder 88 or Kompgrupp	35.75
Objective Kursk or Rails West	23.75
Objective Kursk or Phantasia	30.00
Question	30.00
Operation Market Garden	30.00
Imperium Galacticum, Broadside	23.75
Geopolitique 1990	23.75
Baltic 85 or Gemstone Warrior	20.75
North Atlantic 86	35.75
Germany 1985 or Carrier Force	35.75
War in Russia	47.75
Flight Simulator II	31.00
Night Mission Pinball	22.00
Wizardry I	29.00
Wizardry II	26.75
Wizardry III or Wizardry IV	24.00
Wizardry	15.00
Rendezvous with Rama	24.00
Dragonworld or Shadowkeep	24.00
F-15 Strike Eagle, Solo Flight	21.00
Crusade in Europe	28.00
Fahrenheit 451	24.75
Amazon	24.75
Expedition Amazon	19.00
Zaxxon	19.00
The Tracer Sanction or H.E.R.O.	24.00
Pitfall II or Rock n Bolt	23.75
Ghostbuster or Zenix	23.75
Mind Shadow or Space Shuttle	23.75
The Quest or Ring Quest	20.75
Xyphus or Transylvania	20.75
Frogger	21.00
BC's Quest for Tires	21.00
Kings Quest	23.00
Kings Quest II	27.00
Micro League Baseball	24.00
Where... Is Carmen San Diego	24.00
Summer Games I or II	24.00
Ken Utson's Blackjack	42.00
Castle Wolfenstein	20.00
Beyond Castle Wolfenstein	19.75
Millionaire or Baron	24.00
Tycoon	25.00
Forbidden Quest	24.00
Spirfire Simulator	25.00
Bruce Lee or Conan	23.75
Sarson III	30.00
Death in the Caribbean	21.00
Miner 2049er or the Heist	23.75
How About... Game of Chess	21.00
Adventure Construction Set	31.00
Europe Ablaze	32.00
Carriers at War	32.00
Reach for the Stars	29.00
Hard Hat Mack	13.00
Pinball Construction Set	22.50
Music Construction Set	25.00
The Stranding Stone	13.00
One-On-One	25.50
Archon	22.50
Archon II or Skyfox	25.50
Seven Cities of Gold	25.50
Murder on the Zinderneuf	22.50
Sundog	31.00
Gato	23.75

PRINTERS	
APPLE	
Imagewriter 10"	459.00
Imagewriter 15"	559.00
BROTHER	
HR-15XL	353.00
HR-35	685.00
C. ITOH	
8510AP	289.00
8510AP Plus	319.00
1550AP	435.00
1550BP Plus	455.00
DYNAX	
DX-15	375.00
EPSON	
Spectrum LX-80	229.00
Spectrum LX-90	CALL
FX-80	CALL
FX-85	CALL
FX-185	CALL
LQ-1500	CALL
DX-10	CALL

JUKI	
6100	389.00
MANNESMAN TALLY	
MT-85	380.00
MT-86	450.00
NEC INFO SYSTEMS	
N2030	645.00
N3530	969.00
OKIDATA	
182	215.00
192	349.00
192 Imagewriter	379.00
193	479.00
PANASONIC	
KXP 1090	179.00
KXP 1091	247.00
KXP 1092	369.00
KXP 1093	439.00
KXP 1051 Letter Quality	415.00
QUME	
Dume Printer Line	CALL
SILVER REED	
EXP400P	240.00
EXP500P	244.00
EXP550P	395.00
EXP770P	689.00
STAR MICRONICS	
SG 10	220.00
SG-10C	259.00
SG 15	379.00
SG 10	490.00
SR 15	589.00
SD 10	342.00
SD 15	455.00
TOSHIBA	
P1340	549.00
P331	1,065.00
3515P	CALL

HOME/ACCESSORIES	
212 Apple Cat.	365.00
Accelerator Ite (Titan)	207.00
Apple Cat II	189.00
Apple Mechanic	17.00
Applesoft Compiler	108.00
Applied Eng. OK	CALL
To IMG	CALL
Viewmaster	105.00
Applied Eng.	CALL
Z-80 Plus	105.00
ASCII Pro	77.00
ASCII Multi I/O	164.00
Bank Street Filer	CALL
Bank Street Speller	41.00
Bank Street Writer	41.00
Beagle Graphics	20.00
Beagle Graphics	33.00
Buffered Grappler	139.00
Compuserve Starter Kit	22.00
Crossword Magic	31.00
Cut & Paste	23.75
D-Code	22.50
Disk Quick	16.50
Dollars & Sense	58.00
Dollars & Sense II	68.75
Doss Boss	13.75
Double Take	19.50
Echo II Plus	93.00
Elephant Trunk	19.00
Extra K	22.50
For Cat	19.50
Financial Cookbook	32.00
Fingerprint Plus (Thirdware)	98.00
Flex Type	16.75
Flip n File 50	19.00
Font Paks 1-11 (Each)	11.50
Fontnix 1.5	54.75
Forecast	38.00
Frame Up	16.75
GPI-E	26.95
Graphics Library 1 or 2	14.95
Graphics Magician, The	35.50
Grappler Plus	74.00
Hoyes Mach II	27.00
Hoyes Micromodem Ite w/SC I	33.00
Hoyes Paddles	129.00
Hoyes Smartmodem 1200	CALL
Head Cleaning Kit	379.00
I/O Silver	20.00
Keatonics Keyboards	17.00
Koala Pad	CALL
Kraft Joystick	72.00
Lazerware Lisa V.2.6	31.00
MCT Speed Demon	53.75
Merlin	179.00
Merlin Combo	36.00
Merlin Pro	64.00
Micro Cookbook II/Ite	58.00
Mockingboard A	22.50
Mockingboard B	73.00
Mockingboard C	73.00
Mockingboard D	124.00
Mockingboard E	133.00
Muppet Learning Keys	43.00

New Complete Graphics System	47.75
Nice Print	123.00
Pixit	29.75
CALL	
Pogcom X-100 Modem	380.00
Print It (Textprint)	129.00
Print Shop	27.75
Pro Byter	19.50
Prometheus 1200 External	298.00
Prometheus Internal Ite/II+	287.00
Proto Doss	16.50
Quadram Multi-Core Board	CALL
Satum 128K Ramcard	175.00
Sideways	35.00
Silicon Salad	13.75
Softcard II	269.00
Softem II (Softronics)	124.00
System Saver (Kensington)	61.50
Take One	35.00
TG Selectport	25.00
Thunderlock Plus	107.00
Time Is Money (Turning Point)	51.00
Time Trax Ite or Ite	CALL
Trackhouse Kaypads	CALL
Triple Dump	21.75
Turbo Pascal	38.75
Turbo Toolbox	32.75
Turbo Tutor	21.00
Type Faces	10.95
Typing Tutor I	14.30
Typing Tutor III	30.75
Utility City	16.50
Video 7 RGB Interface Ite, Ite	CALL
Visible 6502	32.00
Zoom Modem Ite	118.00

ORDERS ONLY

TOLL FREE

1-800-382-2242

7 DAYS/WK

9AM to 11PM EST

NO ADDITIONAL CHARGES FOR CREDIT CARD ORDERS

MONITORS	
AMDEK	
Color 300	225.00
Color 500	318.00
Color 600	385.00
Video 300G Green	115.00
Video 300A Amber	119.00
DVM III	130.00
PANASONIC	
TR 120 Green	115.00
TR 120 Amber	120.00
D15 101" Color	178.00
DTM 140-14" RGB Color	394.00
PRINCETON	
HX 12	445.00
RGB Interface	147.50
TAKAN	
Green (Hi-Res)	CALL
Amber (Hi-Res)	CALL
220 13" Composite w/Audio	CALL
420 RGB Color	CALL
410-64 RGB-2 Interface	CALL

BLANK MEDIA	
Elephant 5S/DD	12.00
Elephant DS/DD	21.00
Verbatim 5S/DD	16.00
Verbatim DS/DD	22.00
Memorex 5S/DD	14.95
Memorex (3 1/2" MAC)	27.00
BASF 5S/DD	14.00
Maxell 5S/DD	16.00
EDD III	44.75
Locksmith 5.0	65.00
CIA Files	47.00
Copy II Plus	20.00
Wildcard II	75.00
Copymaster II 128K w/GR. dump	95.00

SPECIALS	
Early Games or Piece of Cake	12.00
Make a Match, Fraction Factory	18.00
The News Room	30.00
Clip Art Effects for Newsroom	17.75
TERRAPIN	
Terrapin Logo	58.50
Terrapin Logo 10 Pack	179.00
TIMEWORKS	
Evelyn Wood Dynamic Reader	42.00
WEEKLY READER	
Sticky Bear Numbers	24.00
Sticky Bear Spell Grabber	24.00
Sticky Bear Townbuilder	24.00
Sticky Bear Typing	24.00

EDUCATIONAL	
APPLE	
LOGO II	80.00
BARRONS	
COMPUTER SAT or GMAT	53.00
CBS	
Adventure Master	26.75
Mastering the SAT	60.00
Forecast or Trax	329.75
DAVIDSON AND ASSOCIATES	
Speed Reader II	40.75
Wordattack, Mathblast, Spellit	28.75
All Davidson, Data Disks	12.00
DESIGNWARE	
Spellcrafter or Spellokazom	24.00
States & Traits, European Nations	26.00
Body Transparent, Mission Alg.	26.00
Remember	48.00
DLM	
Alien Addition, Alligator Mix	20.25
Meteler Multi or Minus Mission	20.25
Demolition Division, Dragon Mix	20.50
Spelling Wiz, Word Invasion	20.50
EDU-WARE/PEACHTREE	
Compu Read	16.75
Compu Math	28.75
Sat or PSAT Word Attack Skills	17.00
Spelling Bee & Reading Primer	22.75
Algebra 1, 2, 3 or 4	22.75
Algebra 5 & 6	27.25
Writing Skills 1, 2, 3, 4, or 5	24.00
Hands on Basic	30.00
Introduction to Counting	25.00
Fractions or Decimals	24.00
HARCOURT BRACE JOVANOVIICH	
Harcourt SAT	46.75
Harcourt GRE or ACT	54.00
GROLIER	
Science Island	24.00
Treasure Hunter	24.00
Easy Graph or Friendly Flier	24.00
HAYDEN	
Word Challenge	12.00
LEARNING COMPANY	
Rockys Boots or Robot Odyssey	29.00
Number Stumper, Reader Rabbit	24.00
Magic Spells or Word Spinner	21.00
Bumble Games or Bumble Plot	24.00
Gertrude's Puzzle or Secrets	26.50
MAGNUM	
Super Speed Reading	30.00
MECC	
Math Series (Each)	29.00
Health Series (Each)	29.00
MILLIKEN	
Math Sequences (Each)	21.00
Number Chase or Pop r' Spell	24.00
PROGRAM DESIGN	
The New Step by Step	73.00
SCARBOROUGH SYSTEMS	
Build a Book About You	24.00
Boston Computer Diet	48.00
MasterType's Writing Wizard	48.00
MasterType's Filer	24.00
MasterType's New & Improved	24.00
SCHOLASTIC WIZWARE	
Fact and Fiction Toolkit IIC	24.00
Microtype 1-8 (Each)	23.75
Story Tree or Story Maker	24.00
Turtle Tracks or Agent USA	23.75
Operation Frog, Logic Builders	23.75
Logo Robot or Kids at Work	15.00
SPINNAKER SOFTWARE	
Fraction Fever or Face Maker	15.00
File and Report or Spreadsheet	36.00
Snooper Troops 1 or 2	20.00
Story Machine, Grandma's House	15.00
Kindercomp or Kids on Keys	15.00
Word Processor	36.00
Alphabet Zoo or Kidwriter	18.00
In Search Of	20.00
SPRINGBOARD	
Early Games or Piece of Cake	12.00
Make a Match, Fraction Factory	18.00
The News Room	30.00
Clip Art Effects for Newsroom	17.75

DISK DRIVES	
APPLE	
Disk II Drive	275.00
Duo Disk w/Acc. Kit	565.00
Ite Add-on	255.00
Mac Add-on	369.00
MICRO SCI	
A2 143K	168.00
Slimline Ite	178.00
Slimline Ite	168.00
Controller Card	53.00
QUARK	
QC-10 w/catalyst	CALL
BUSINESS	
ADVANCED LOGIC SYSTEMS	
The Handlers Package	98.00
APPLE	
Appletworks	175.00
Apple Writer IIE	120.00
Apple Access	55.00
Quickfile	75.00
ARTSCI	
Magi Office Systems	149.00
Magi Calc 3.3 or Pro DOS	59.00
Magi Window II	90.00
ASHTON TATE	
dBase II	278.00
BPI	
General Act., AR, AP, GL, Pay	221.00
Time Accounting	221.00
CONTINENTAL SOFTWARE	
Home Accountant	41.75
Tax Advantage	41.75
FCM/FL	58.00
GI/AR/AP/Payroll	134.00
DOW JONES SOFTWARE	
Market Analyzer or Microscope	205.00
Mkt Mer or Spreadsheet Link	148.00
HAYDEN SOFTWARE	
The Writer	30.00
ROAD SOFTWARE SERVICES	
Real Estate Analyzer II	135.00
HUMAN EDGE	
Communication or Sales Edge	88.75
MGT or Negotiation Edge	88.75
Mind Prober	29.00
KENSINGTON	
Format II Enhanced	88.00
LIVING VIDEO	
Think Tank II/IE	84.00
MEGAHAUS	
Megafinder	90.00
Megaworks	74.75
MICROPRO	
WordStar	189.00
WordStar Professional	265.00
MICROSOFT	
Multiplan	55.00
MICROSTUF	
Cassults	107.00
ORGANIZATIONAL SOFTWARE	
Omnis 3	247.00
PEACHTREE	
Back to Basics Accounting	114.00
Word Juggler w/Lexicheck	113.00
PROGRAM DESIGN	
The New Step by Step	73.00
SCARBOROUGH SYSTEMS	
Build a Book About You	24.00
Boston Computer Diet	48.00
MasterType's Writing Wizard	48.00
MasterType's Filer	24.00
MasterType's New & Improved	24.00
SCHOLASTIC WIZWARE	
Fact and Fiction Toolkit IIC	24.00
Microtype 1-8 (Each)	23.75
Story Tree or Story Maker	24.00
Turtle Tracks or Agent USA	23.75
Operation Frog, Logic Builders	23.75
Logo Robot or Kids at Work	15.00
SPINNAKER SOFTWARE	
Fraction Fever or Face Maker	15.00
File and Report or Spreadsheet	36.00
Snooper Troops 1 or 2	20.00
Story Machine, Grandma's House	15.00
Kindercomp or Kids on Keys	15.00
Word Processor	36.00
Alphabet Zoo or Kidwriter	18.00
In Search Of	20.00
SPRINGBOARD	
Early Games or Piece of Cake	12.00
Make a Match, Fraction Factory	18.00
The News Room	30.00
Clip Art Effects for Newsroom	17.75
TERRAPIN	
Terrapin Logo	58.50
Terrapin Logo 10 Pack	179.00
TIMEWORKS	
Evelyn Wood Dynamic Reader	42.00
WEEKLY READER	
Sticky Bear Numbers	24.00
Sticky Bear Spell Grabber	24.00
Sticky Bear Townbuilder	24.00
Sticky Bear Typing	24.00
MACINTOSH	
A	

**Protect
the fruits of
apple!**

Call (800) 847-4176



IIe Foam Padded Carrying Case
with
Removable Cover

**Macintosh
Carrying Case**
\$104.50*



*UPS Shipping Included.

shoulder strap
\$5.25

IIc Foam Padded Flight Case

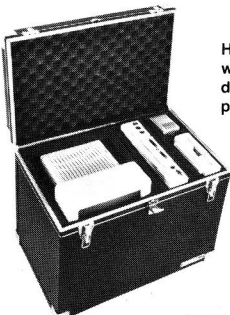

Holds: IIc, monitor
w/stand, external
disc drive, power
pack, mouse.

\$179.50*

*UPS Shipping Included.

**Call for Complete
Computer Case Catalog.**

For
Fast
Service!



CREDIT CARD CUSTOMERS
CALL TOLL FREE
800-847-4176
(outside N.Y. State)



Fiberbilt
CASES, INC.

601 West 26th Street
New York, New York 10001-1199
(212) 675-5820 (N.Y. State only)
(800) 847-4176 (Toll Free)

RIGHT OF ASSEMBLY

Table. The effects of certain CALLs.

Address to CALL	Effect
64538	Moves cursor up
64614	Moves cursor down
64528	Moves cursor left
64500	Moves cursor right
64780	Waits for a keypress
64858	Waits for a return keypress
64668	Clears to end of line from cursor
64578	Clears to bottom of screen from cursor
62436	Shows Hi-Res Page 1
62450	Clears Hi-Res screen to black (without showing it in TEXT, but it does destroy the current Hi-Res page setting for HPLOTS, and so on)
62454	Clears Hi-Res screen to last color plotted
54915	Clears Applesoft stack of pending FOR...NEXT and GOSUB counters and any other lingering problems

When your program says PRINT "HELLO", this intermediate program looks up the word PRINT in a list of commands, then executes a short machine-language program to do what you think of as the actual PRINT command.

It turns out that Applesoft really is machine language—each time a statement in your Applesoft program is executed, the computer carries out a short machine-language program (or, more properly, a *subroutine*). The main reason Applesoft runs more slowly than a pure machine-language program is the time the Applesoft interpreter (that middleman we were talking about) takes to decide which routine to execute for each command in the various lines of BASIC as the program is running.

Maps, Addresses, and Calls to Mom

If you know how to write even a simple program in Applesoft BASIC, you're well on your way to knowing how to write a program in machine language. As a matter of fact, BASIC was originally designed as a teaching tool to help people learn how to program in machine language.

In BASIC, a line number identifies a place in your program. For example, to jump to a given routine you might use the statement GOSUB 1000. In machine language, it's the *location* that's important, and each location is identified with an *address*. (Computer people just love to start counting with

zero, so the addresses of those locations are numbered 0, 1, 2, and so on, up to 65,535.) Just like a street address, each address of a memory location lets you find only one spot in the computer to look at or in which to store a number.

You can make a useful diagram of the various memory locations in your Apple and the functions of the different parts of memory. In upcoming lessons, you can use this *memory map* as you explore the Apple. For now, though, it's enough just to understand that for a machine-language program, the *location* of a value in the computer is as important as the line numbers in a BASIC program.

If you've ever used a CALL statement in Applesoft, you've already used the machine-language equivalent of BASIC's GOSUB command. For example, CALL 32768 from BASIC tells the computer to start running a machine-language program at memory location 32768. As long as a machine-language program is in that location and the routine eventually ends with the machine-language equivalent of RETURN, program control will return to your Applesoft program when the routine is finished.

Using Applesoft's CALL command to access short machine-language routines (ones that either already exist in the computer or that you have written yourself) is probably one of the best ways to start using machine-language programming techniques in your own programs. The **Table**

APPLEWORKS ENHANCEMENTS

*Read why Applied Engineering
is the acknowledged leader in AppleWorks enhancements*

- Applied Engineering was first to expand Appleworks beyond 55K.
 - Applied Engineering was first to eliminate disk access on Drive 1 in Appleworks, thereby dramatically speeding up the program and reducing disk drive wear.
 - Applied Engineering was first to expand AppleWorks to 1 megabyte of memory.
 - Applied Engineering was first to expand AppleWorks to 2.5 megabytes.
 - Applied Engineering was first to provide auto segmenting on large files so any size file can be saved on regular floppies.
 - Applied Engineering was first to increase the maximum number of records in the data base from 1350 to 5100.
 - Applied Engineering was first to increase the number of lines in the AppleWorks word processor from 2250 to 5100.
 - Applied Engineering was first to display the time and date on the AppleWorks screen.
 - Applied Engineering was first to provide auto dating as part of the data base field.
 - Applied Engineering was first to provide auto time stamping as part of the data base field.
 - Applied Engineering was first to give push-button telecommunication power to AppleWorks by merging the word processor to M.C.I. mail.
-

With all of these firsts, it's no wonder most people choose Applied Engineering when they want enhancements to Appleworks. Especially when you consider that nearly all the "firsts" listed above are "onlys" too. And our Appleworks enhancements are as easy to use as inserting a disk and pressing return because all enhancements are merged with the AppleWorks program disk and stay there out of sight until needed, only now AppleWorks will run up to 20 times faster, and be easier to use at the same time.

And we're working on new improvements to AppleWorks all the time, so the few remaining criticisms the software reviewers gave AppleWorks will vanish forever. So if you want more out of AppleWorks, order RamWorks and Timemaster H.O. for the Iie or Z-RAM and Iic System Clock for the Iic. You'll find specifications and prices for these products listed in this magazine. Please look for Applied Engineering in the advertiser's index.

There's no question about how they'll increase your productivity. The only question you'll have is how you ever got along without them.

214-241-6060



APPLIED ENGINEERING
"We Set the Standard"

Spell Checker and Mail-merge for Appleworks Only \$49.95!

Now... the luxury of a spelling checker and mailmerge for only \$49.95

Spellworks was written exclusively for Appleworks... it fits Appleworks like a glove. Typing and spelling errors are a thing of the past when you use Spellworks! If you've got Appleworks, you need Spellworks. It's a steal - spelled s-t-e-a-l!

- Utility that Merges Appleworks Data Base With Appleworks Word Processor.
- 90,000 Words
- Checks 10 words per second
- Word count 10 per second
- All on one diskette!

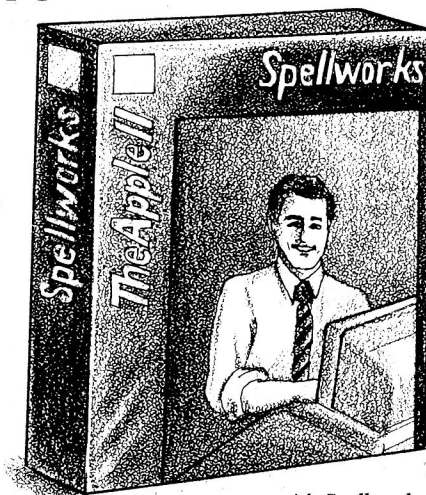

... now with Spellworks
no more spelling errors!

Advanced Logic  Systems, Inc.

1195 E. Arques Avenue • Sunnyvale, CA 94086 • 408/730-0307
Circle 24 on Reader Service Card.

shows a short list of some of the machine-language routines you can CALL right from Applesoft BASIC.

To see how you can use these CALLs, consider some short examples. **Listing 1** shows how you can draw on the hi-res screen without displaying the screen. After the program draws the lines, it switches the display to the Hi-Res mode (page flipping), and the lines appear instantly. The command HGR usually clears the screen to black. By using the Hi-Res CALLs listed in the **Table**, however, you can start your program with a white screen (**Listing 2**).

Another trick you can add to an Applesoft program to make CALLs more understandable is to set Applesoft variables equal to the address you want to CALL—that is, make the names of the variables a clue to the function of the routine itself (**Listing 3**). The main caution with naming routines is to remember that Applesoft uses only the first two letters of the name. This means you can't use one routine called MOVEUP and another called MOVEDOWN, for example. Also, Applesoft key words are not legal variable names; you can't create a variable called PRINT, for instance. You can set a variable equal to MOM, though, and then you'll be able to say you call MOM often.

PEEKs and POKEs

The commands POKE and PEEK are two other Applesoft links to the world of machine language (see line 20 of **Listing 1**). A machine-language program often uses the contents of a particular memory location in the computer to store a meaningful value or to look at a location to see the action the program should take.

In Applesoft, POKE puts a number value (always in the range of zero to 255) into a particular memory location (in the range of zero to 65535). Many Applesoft routines (including the one at line 25 of **Listing 1**) use location 230 as a reference to drawing on Hi-Res page 1 or page 2. You usually set this location when you do an HGR or HGR2 from Applesoft.

Since **Listing 1** is "fooling" Applesoft into later clearing the Hi-Res page, you must put the value 32 in location 230 if you want page 1 to clear properly. If you wanted to clear Hi-Res page 2, you would store a 64 in location 230.

Sometimes a machine-language routine alters memory locations as it op-

DMP Utilities



24 Character sets to Download to your Imagewriter.

Font Editor to create custom characters.

Converts hi-res fonts to work with the Imagewriter.

Simple to use --- menu driven.

67 page User's Manual.

Character sets work with any Apple II application program, including AppleWorks, VisiCalc, and AppleWriter.

"Excellent"

Softalk, Feb 1984

"A necessity"

Creative Computing, June 1984

They cost \$50 (+\$2 p&h). Versions also available for Epson FX/JX printers. Dealer inquiries invited. Imagewriter, AppleWorks & AppleWriter are Trademarks of Apple Computer. Epson is a Trademark of the Epson Corp.

Circle the reader's service card or phone us to find out more about DMP Utilities.

Vilberg Bros. Computing, Inc.
4201 Hegg Avenue
Madison, WI 53716
(608) 221-0842



Foreign Computer Stores/ Magazine Dealers

You have a large technical audience that speaks English and is in need of the kind of microcomputer information that CW/Peterborough provides.

Provide your audience with the magazine they need and make money at the same time. For details on selling **80 MICRO**, **inCider**, **HOT CoCo**, **RUN** contact:

SANDRA JOSEPH
WORLD WIDE MEDIA
386 PARK AVE., SOUTH
NEW YORK, NY 10016
PHONE (212) 686-1520
TELEX—620430

Imagewriter™ Owners



In less than 5 minutes, KITCHEN PLANNER will help you plan up to 14 days of balanced meals the way YOU want them and print the Menu and Shopping List.

* EASY TO USE * SAVES TIME *
* SAVES MONEY *

- "Saves 5-6 hrs a month and keeps our meals varied." - Family Computing Magazine Cover Story, November 1984.
- "The concept of this program is great for my family . . . I have only owned the program for 3 weeks and our shopping expenses have been reduced by about \$25 a week . . . that's great!" - Mrs. S., Illinois
- "This has been without a doubt the most useful disk I have purchased for my home computer." - Mrs. T., Wisconsin

SATISFACTION GUARANTEED

Send Check or Money Order to:

SAV-SOFT PRODUCTS
P.O. Box 24898
San Jose, CA 95154

\$29⁹⁵

(add \$1.50 handling; in CA add 6¼%)

VISA, MC call : (408) 978-1048

48K Apple II, II+, IIe, IIc, I disk, printer
Apple is a trademark of Apple Computer, Inc.

Circle 223 on Reader Service Card.

Software That Works For Generations

6 Types of Charts and Sheets
Indices
User Fields
Notes, Footnotes and Sources
No Limits
Adapts to Your Hardware
Comprehensive
Easy to Use
And Much, Much More

Send for brochure and sample printouts.

Family Roots includes detailed manual and 2 full diskettes of programs for your Apple II, IBM PC, Commodore 64 and CP/M.*

Other genealogy software also available.

Price \$185. Satisfaction Guaranteed.

American Express, Visa & Mastercard Accepted

*Trademarks for Apple Computer, Inc., International



Business Machines, CBM, Inc., & Digital Research.

QUINSEPT, INC.

P.O. Box 216, Lexington, MA 02173
(617) 641-2930

Circle 16 on Reader Service Card.

RIGHT OF ASSEMBLY

Listing 1. Hi-res trickery.

```
10 HOME
15 PRINT "WELCOME TO HI-RES
    TRICKERY"
20 POKE 230,32: REM SET HI-RES
    PAGE '1'
25 CALL 62450 : REM CLEAR HI-RES
    SCREEN TO BLACK
30 REM DRAW A FRAME
35 HCOLOR = 3: REM SET HCOLOR TO
    WHITE
40 HPLOT 0,0 TO 279,0 TO 279,159 TO
    0,159 TO 0,0
45 REM DRAW A SHAPE
50 HPLOT 140,80: REM STARTING POINT
55 FOR I=1 TO 100
60 X = RND(1)*279
65 Y = RND(1)*159
70 HPLOT TO X,Y
75 NEXT I
80 REM SWITCH TO HI-RES SCREEN
85 CALL 62436 : REM SHOW HI-RES
    PAGE 1
```

Listing 2. HGR in color.

```
10 HOME
15 PRINT "WHITE HGR DEMO"
20 POKE 230,32: REM SET HI-RES
    PAGE '1'
25 HCOLOR = 3 : REM SET HCOLOR
    TO WHITE
30 HPLOT 0,0 : REM PLOT IT ONCE
35 CALL 62454: REM CLEAR SCREEN
    TO WHITE
40 CALL 62436: REM SHOW HI-RES
    PAGE 1
45 POKE 230,32: REM RESTORE PAGE
    SETTING
```

Listing 3. CALLing them by name.

```
10 UP = 64538: DOWN = 64614:
    LEFT = 64528: RIGHT = 64500
20 HOME
30 HTAB 20:VTAB 12:REM CENTER
    CURSOR
40 GET A$
50 IF A$ = "U" THEN CALL UP
55 IF A$ = "D" THEN CALL DOWN
60 IF A$ = "L" THEN CALL LEFT
65 IF A$ = "R" THEN CALL RIGHT
70 IF A$ = "Q" THEN END
75 GOTO 40
```

erates. The clear-screen routine stores the value zero in a large block of memory used to determine the contents of a given memory location in the Apple.

If you added the line:

```
90 PRINT PEEK(230)
```

to Listing 2, you would discover that location 230 changes after the program performs CALL 62436. Being aware of this is valuable, since the contents of location 230 are important to other Hi-Res commands, such as HPLOT. If you use CALL 62436 in your Applesoft programs, be sure to restore location 230 with a POKE 230,32 to keep things working properly.

Until We Meet Again. . .

The important thing this month is to understand that your Apple computer contains many levels of "programs." You're familiar with Applesoft BASIC, but, ultimately, the computer actually runs a series of number values stored in memory, called a machine-language program.

Your computer calls a machine-language program by jumping to a given address, rather than a line number as in BASIC. Most machine-language routines are like BASIC sub-routines, and eventually return control to the point from which the computer called them. This means you can use them as you would BASIC sub-routines from within an Applesoft program to enhance the programs you're writing.

You can use the Applesoft commands POKE and PEEK to alter the contents of memory and to examine any given memory location to see what's already there. You may want to go back to programs you've seen in magazines or on your local user-group program disks to look for POKEs, PEEKs, and CALLs to see how you can use them in many different Applesoft programs.

In upcoming issues, you'll learn more about machine-language programs and how to create them yourself. Best of all, you'll gain an insight into the way your computer really works. ■

Roger Wagner is the author of Assembly Line: the Book and is president of Roger Wagner Publishing, the publisher of Merlin and Merlin Pro assemblers. Write to Roger at Roger Wagner Publishing, 10761 Woodside Avenue, Suite E, P.O. Box 582, San-tee, CA 92071.

Expanding Your IIC Is Easy With Z-RAM™

Z-RAM for the IIC is available with 256K or 512K of additional memory and a powerful Z-80 microprocessor for running CP/M software.

Z-RAM fits neatly inside the IIC. Installation is easy, clear instructions show you how without voiding your IIC warranty. You'll need a screwdriver and about 10 minutes (if you can change a light bulb you can install Z-RAM).

Z-RAM and Appleworks will knock your socks off.

A 256K Z-RAM will give you a 229K available desktop and Appleworks will be completely loaded into memory. Appleworks will now run about 10 times faster in your IIC with 1 disk drive than in other IIC's with 2 disk drives. And only Z-RAM increases the maximum number of records in the data base and lines in the word processor. And only Z-RAM will auto segment large files so any size file can be saved on regular floppies or a hard disk. A 512K Z-RAM will give you a 413K available desktop. A 256K Z-RAM can be upgraded to 512K by just plugging in more memory chips.



Z-RAM is also a high speed solid state disk drive. With Z-RAM, your programs will load and save over 20 times faster. Z-RAM's RAM disk is compatible with Applesoft, ProDOS, DOS 3.3, PASCAL and CP/M. And with Z-RAM, you can copy a disk in one pass. Just insert the original, remove the original, insert blank disk! That's it! Z-RAM is another disk drive, only 20 times faster, 4 times larger capacity, and no whirring, clicking or waiting!

But before you start panting over all that extra memory, don't forget that the Z-RAM card has a built-in high speed Z-80 processor chip that allows you to run CP/M programs like Wordstar, dBASE II, Turbo PASCAL, Microsoft BASIC, FORTRAN and COBOL and over 3,000 other CP/M programs. So Z-RAM not only makes Apple programs run better and faster, it lets you run MORE programs.

With the Z-RAM card installed, your IIC is still your IIC only now you'll have that extra memory that Appleworks and other programs need. And you can run all that great CP/M software that others can only dream about.

Z-RAM is 100% compatible with all IIC software and hardware including the mouse, 2nd disk, modem and printer. Z-RAM is easily handled by the IIC power supply as power consumption is kept very low by using two custom integrated circuits and a patent pending power saving design. And Z-RAM is from Applied Engineering, the acknowledged leader and innovator of accessories for the Apple.

Z-RAM comes complete with manual, RAM disk software, Z-80 operating system, CP/M manual and a 5 year no hassle warranty.

So the next time somebody asks you why you didn't get an IBM, tell him you bought a IIC because the IBM didn't have enough memory and was too slow and couldn't run CP/M software. And tell him you made it past the 8th grade.

Z-RAM with 256K **\$399**
Z-RAM with 512K **\$479**

If you want to run CP/M software, but don't need more memory, may we suggest our Z-80c card. The Z-80c offers the same CP/M performance as Z-RAM but has no memory expansion ports. And the Z-80c will not affect the running of Apple programs. The Z-80c is priced at only \$159.00 and should you ever want to upgrade to Z-RAM, we'll refund your full purchase price.

Call (214) 241-6060

9 a.m. to 11 p.m. 7 days a week or

Send check or money order to:

Applied Engineering
P. O. Box 798
Carrollton, Texas 75006



MasterCard



Visa and

C.O.D. welcome. No extra charge for credit cards.
Texas residents add 5½% sales tax. Add \$10.00 if outside U.S.A.



APPLIED ENGINEERING
"We Set the Standard"

BANKRUPTCY COMPUTER

FACTORY NEW! FIRST QUALITY!

For APPLE Computers at 50% to 80% OFF!

Enjoy **BIG SAVINGS** on high-quality software for **BUSINESS, EDUCATION, HOME MANAGEMENT, COMPUTER MANAGEMENT** and exciting **VIDEO GAMES!**

SOFTSMITH, a leading manufacturer of excellent quality software, was forced into bankruptcy due to intense competition. We are authorized to liquidate this bankruptcy inventory at **BIG SAVINGS!** Programs are designed for use with Apple II, II+ or IIe computers. (See individual descriptions for requirements.)

EDUCATION

Mfr. Suggested Retail
\$29.95 and up

NOW ONLY... \$10 Ea.
Shipping, handling: \$3 ea.

COLOR ME. Item H-640-63542-04. Introduces youngsters to exciting world of computer graphics, colors, textures. Enhances artistic creativity with 25 different pictures and 32 colors to choose from. Ages 5 to 12. Requires: Apple® II, II+, IIe, 48K; one disk drive; two paddles or joysticks; color monitor.

PERCEPTION. Item H-640-63542-09. Seven programs in one! Helps improve visual perceptible skills such as comparing shapes, sizes, lengths and hand/eye coordination. Requires: Apple® II with Applesoft II+, IIe; 48K; DOS 3.3; one disk drive; paddle controllers.

WORD SEARCH. Item H-640-63542-19. For creating and printing word search puzzles. Helps beginning readers find and identify words. Requires: Apple® II with Applesoft II+, IIe; 48K; DOS 3.3; one disk drive; printer.

ALGEBRA I. Item H-640-63542-01. Helps beginner-review student master basic concepts in algebra, consisting of properties and equation operations. Includes: Definitions, Number Line Operations, Sets, Evaluating Expressions and Rules for Equations Reduction. Requires: Apple® II, II+, IIe; 48K RAM Applesoft; DOS 3.3; one disk drive.

ALGEBRA III. Item H-640-63542-02. Learn algebraic concepts: Five lessons: Monomials, Polynomials, Simple Factoring, Factoring and Binomials and Quadratic Trinomials. For self-paced study. Requires: Apple® II with Applesoft, II+, IIe; 48K; DOS 3.3; one disk drive; color monitor (optional).

STATISTICS. Item H-640-63542-03. A generalized statistics system. Six programs: Mean, Variance and Standard Deviation, Correlation Coefficient, Normal Distribution, Chi-Square Test, Chi-Square Distribution,

and T-Test. Requires: Apple® II, II+, IIe; 48K; DOS 3.3; one disk drive; printer (optional).

CON-PUTATION. Item H-640-63542-05. Learn basic math by making a match and scoring a point in this game of concentration and calculation. Music and graphic displays. Requires: Apple® II with Applesoft, II+, IIe; DOS 3.3, 48K; one disk drive.

DECIMALS. Item H-640-63542-06. For primary level education. Entertains while it teaches and rewards child for learning. Can be customized to suit special needs of working with decimals in all kinds of arithmetic. Requires: Apple® II with Applesoft, II+, IIe; 48K RAM; DOS 3.3; one disk drive.

FRACTIONS. Item H-640-63542-07. Teaches addition, subtraction, multiplication, and division of fractions. Can be customized to fit child's needs and learning pace. Requires: Apple® II with Applesoft, II+, IIe; 48K; DOS 3.3; one disk drive.

MATH SKILLS. Item H-640-63542-08. Provides primary level instruction in basic arithmetic. Interactive format, animated pictures, captivating sounds. Requires: Apple® II with Applesoft, II+, IIe; 48K; DOS 3.3; one disk drive.

THE BIG MATH ATTACK. Item H-640-63542-17. A game-like educational program for primary school children to learn and perfect basic addition, subtraction, multiplication, division skills. Requires: Apple® II with Applesoft, II+, IIe; 48K; DOS 3.3; one disk drive.

VOLCANOES. Item H-640-63542-18. Sophisticated game for older children and adults. Comprises an introductory course to volcanic processes. Requires: Apple® II, II+, IIe; 48K RAM; Applesoft; one disk drive; DOS 3.3.

SPELL MASTER. Series of lessons with hundreds of commonly misspelled words, geared to a particular grade in school (4 through 6). Plus an adult disk with words from a secretarial handbook! Requires: Apple® II with Applesoft, II+, IIe; 48K; DOS 3.3; one disk drive; printer (optional).

Spell Master grades 4, 5, 6, plus controller disk. Item 640-63542-01-66

Spell Master grades 7, 8, Adult, plus controller disk. Item 640-63542-01-67

Liquidation price for set of three **\$24** per set

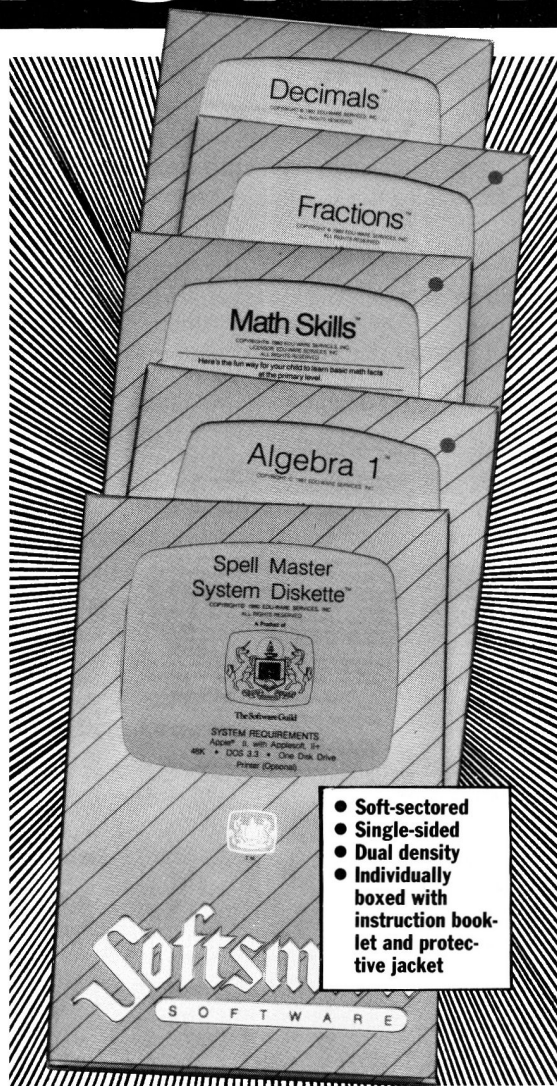

- Soft-sectored
- Single-sided
- Dual density
- Individually boxed with instruction booklet and protective jacket

BUSINESS

Mfr. Suggested Retail
\$49.95 and up

NOW ONLY... \$24 Ea.
Shipping, handling: \$3 ea.

ACCOUNTS PAYABLE. Item H-640-63542-20. Maintain purchase and cash disbursement journals, post vendor accounts, print journals and reports, keep track of vendor purchases and oversee overall accounts payable. Requires: Apple® II with Applesoft, II+, 48K; DOS 3.3; two disk drives; 132 column printer.

GENERAL LEDGER. Item H-640-63542-22. Provides your business with a complete

and easy-to-use computerized ledger. Requires: Apple® II with Applesoft, II+, DOS 3.3; two disk drives; 132 column printer.

OPTIONX. Item H-640-63542-23. Analyzes historical data, recent events and your projections through sophisticated proven equations. Aids in assimilation and/or interpretation of statistical information pertaining to securities transactions. Requires: Apple® II with Applesoft, II+, 48K RAM; DOS 3.3; one or two disk drives; printer (optional).

WORDSMITH. Item H-640-63542-24. Word processing system provides editing formatting and printing features. Requires: Apple® II, Apple II+, 48K RAM; DOS 3.3; one disk drive.

PAYROLL. Item H-640-63542-25. For small business payroll bookkeeping needs. Requires: Apple® II with Applesoft, II+, 48K; two disk drives; 132 column printer.

LIST MASTER. Item H-640-63542-26. Easy, flexible program for managing large lists. Requires: Apple® II, II+, 48K RAM; DOS 3.3; at least one disk drive; printer (optional).

DINNER ON A DISK. Item H-640-63542-50. Computerized cookbook of recipes. Press button and any of dozens of recipes appears on screen. Another press, and you have a copy of recipe to take to the store or give to a

LIQUIDATION! SOFTWARE!

friend. Requires: Apple® II, II+; 48K RAM; Applesoft; DOS 3.3; one disk drive; printer (optional).

DRINKS ON A DISK. Item H-640-63542-51. Computerized book of drinks! 100 different drink recipes to choose from at press of a button! For printout, press another button! Requires: Apple® II with Applesoft, II+, IIe; 48K; DOS 3.3; one disk drive; printer (optional).

**HOME MANAGEMENT
and COMPUTER
MANAGEMENT**

Mfr. Suggested Retail
\$29.95 and up

NOW ONLY... \$10 Ea.

Shipping, handling: \$3 ea.

ROOTS/M. Item H-640-63542-53. Help trace your family's heritage by organizing family tree information. Go back 99 generations! Requires: Apple® II, II+, IIe; 32K; two disk drives; 80 column card; Microsoft CP/M card; printer (optional).

CONDOR I. Item H-640-63542-27. Micro-computer database available for information processing, inventory control, mailing lists, accounting functions, personnel management, customer orders and more. Requires: Apple® II, II+; 64K; two disk drives; printer (optional); Microsoft CP/M; 80 column card.

BUGBYTER. Item H-640-63542-54. Gives you knowledge of computer memory, along with the ability to disassemble, single-step and trace execute, debug, edit, and a host of other conveniences. Requires: Apple® II, II+, IIe; 24K; DOS 3.3; one disk drive; monochrome monitor; game paddle (optional).

DISK DIRECTOR. Item H-640-63542-55. Use this program to manipulate and organize DOS files, filenames, and entire disks. Some capabilities include: restoration of deleted files, special methods of copying, catalog restructuring and disk integrity checking. Requires: Apple® II, II+, IIe; 48K; DOS 3.3; one or two disk drives.

SECUREGUARD. Item H-640-63542-28. Uses a unique "two-key" system to encode and decode text or data. Requires: Apple® II, II+; two disk drives; printer; CP/M operating system; 80 column card; Z-80 card.

VIDEO GAMES

Mfr. Suggested Retail
\$29.95 and up

NOW ONLY... \$10 Ea.

Shipping, handling: \$3 ea.

POLLYWOG. Item H-640-63542-48. First you're an egg, then a full-grown frog. You play to avoid getting devoured by "orange creepies" and the great white killer fish. Requires: Apple® II, II+, IIe; 1 disk drive; color monitor or TV; joystick.

LAZERSILK. Item H-640-63542-46. You're a Spyder, defending your web from being torn apart. You must outwit a variety of

enemy creatures; capture, bundle or shoot them. Beware! They're cunning and deadly! Requires: Apple® II, II+, IIe; 48K; 1 disk drive; DOS 3.3; joystick (optional).

FIREBIRD. Item H-640-63542-42. You're Piggo (fearless firepig), guarding your town from fire. The vicious Firebird races through, leaving the whole town in flames! You must put out flames in buildings, save inhabitants from death. Requires: Apple® II, II+, IIe; 48K; 1 disk drive; DOS 3.3.

CROSS COUNTRY RALLEY. Item H-640-63542-41. You're selected to test drive a super new Ferrari in a big race. Follow a treacherous course, make 8 checkpoints, return to finish line in record time. 3 "jam cars" try to force you off the track. Requires: Apple® II, IIe; 48K; 1 disk drive; DOS 3.3; joystick (optional).

THE FINAL FRONTIER. Item H-640-63542-32. Pilot an advanced version of the original NASA shuttle. Object: liftoff, rendezvous, approach and final docking with an orbiting space station. Radar systems will help you, but your piloting skills are vital to success! Requires: Apple® II, II+, IIe; 48K; Applesoft; DOS 3.3; 1 disk drive; joystick (optional).

ACEY-DUECY. Item H-640-63542-29. A fast-moving card game. Can make you a billionaire or a pauper in just a single play. Compete with the computer or with your friends. Play odds or intuition. Requires: Apple® II, II+, IIe; 1 disk drive; DOS 3.3.

CONGLOMERATES COLLIDE. Item H-640-63542-30. Manipulate cash, stock, subsidiary companies to survive and prevail in the tough corporate world. Requires: Apple® II with Applesoft, II+, IIe; 48K; 1 disk drive; DOS 3.3; color monitor optional.

MAX-COMMAND. Item H-640-63542-34. Military buildup is taking place between your home country and another major power. Your mission: military defeat of enemy. Requires: Apple® II with Applesoft, II+, IIe; 48K; 1 disk drive; DOS 3.3.

SPACE CONQUERORS. Item H-640-63542-38. You are landing on another planet. Your instruments indicate it is much like the earth. You choose to land, but will face unknown obstacles! Requires: Apple® II with Applesoft, II+, IIe; 48K; DOS 3.3; 1 disk drive; color monitor preferable.

THE PRISONER. Item H-640-63542-39. You ARE the prisoner! With only your intelligence, you must repel the brainwashing of the authorities who are trying to break you down. Can you escape, or will you always be "The Prisoner"? Requires: Apple® II with Applesoft, II+, IIe; 48K; 1 disk drive; DOS 3.3.

LUNAR PINBALL. Item H-640-63542-47. Ding, ring, bing, the ball's in play! All the excitement of planetary pinball in zero gravity playing field. All the sounds of real pinball. Lights blink as score adds up. Add: ten flippers and force field shields! Nothing on earth quite like this! Requires: Apple® II with Applesoft, II+, IIe; 48K RAM; DOS 3.3; 1 disk drive, game paddle.

ASTRO-ATTACK. Item H-640-63542-40. Control rocket ship! Climb, dive, drop bombs! Watch out for ground defenders aiming laser cannons at you! Adjustable difficulty level. Requires: Apple® II, II+, IIe; 48K RAM; DOS 3.3; 1 disk drive.

MIDNIGHT MALADY. Item H-640-63542-35. You're a member of a small medieval village. You wake in the morning with a wound in your arm and hear about a werewolf, and you must find an antidote before full moon rises tonight. Requires: Apple® II, II+, IIe; 48K RAM; 1 disk drive; DOS 3.3.

GUARDIAN. Item H-640-63542-43. Year 2112. The sacred "Emerald of Syrinx" is in your care. Because it is so valuable, many would kill you for it. You must protect yourself, the emerald, and get safely through the 6 levels of the Dungeons of Kailyn! Requires: Apple® II, II+, IIe; 48K RAM; Applesoft; DOS 3.3; 1 disk drive; joystick (optional).

RUSSKI DÜCK. Item H-640-63542-37.

Secret MX missile plans are in enemy hands. You're a special agent and have intercepted a message that reads, "get the duck and leave at midnight." You assume plans are secreted in a duck decoy. You must find them and return them to CIA, avoiding booby traps along the way that can be deadly. Requires: Apple® II, II+, IIe; 48K RAM; DOS 3.3; 1 disk drive.

CREATURE VENTURE. Item H-640-63542-31. You've inherited your rich uncle's mansion. To receive inheritance, you must rid the mansion of horrible creatures that possess it... and find the buried treasure. Requires: Apple® II, II+, IIe; 48K; DOS 3.3; 1 disk drive; Applesoft ROM.

SPREADSHEET SOFTWARE
For Apple II or Apple IIe



This is NOT a bankruptcy item! But it IS an inventory CLOSEOUT by Videx, the manufacturer. And that's the reason for our extremely LOW price! Ultra Plan Spreadsheet lets you create and modify schedules and reports for a wide variety of needs by turning your computer into a huge mathematical worksheet. 254 rows and 63 columns.

Mfr. List: \$99.95 **\$19**
Liquidation Price

Item H-640-64188-00
Shipping, handling: \$4.50



Credit card customers can order by phone 24 hours a day, 7 days a week



Toll-Free 1-800-328-0609



Your check is welcome. No delays in orders paid by check.

C.O.M.B. CO.®/Liquidator Item H-640
14605 28th Avenue N./Minneapolis, Minn. 55441-3397

Please send the items indicated below. (Minnesota residents add 6% sales tax. Allow 3-4 weeks delivery. Sorry, no C.O.D.)

Item No.	Title	Price	Ship. Hand.

(To order more items, attach a separate list with your name and address on it.)
 My check or money order is enclosed. (No delays in processing orders paid by check, thanks to TeleCheck.)

Charge my: MasterCard™ VISA

Acct. No. _____ Exp. _____

PLEASE PRINT CLEARLY

Name _____

Address _____

City _____ State _____ ZIP _____

Phone _____

Sign here _____

C.O.M.B. CO.®
Authorized Liquidator
14605 28th AVENUE NORTH
MINNEAPOLIS, MINNESOTA 55441-3397

**THE X-10
POWERHOUSE
DOES
EVERYTHING
BUT PUT OUT
THE CAT.**

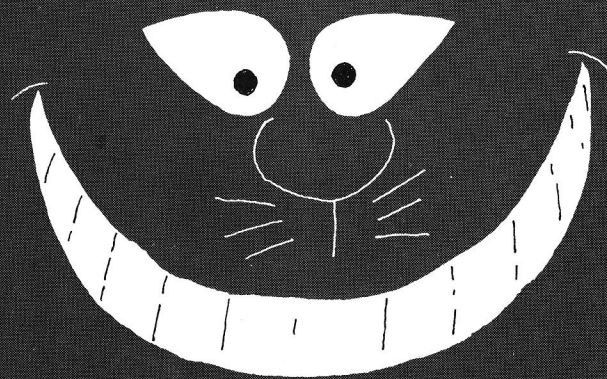

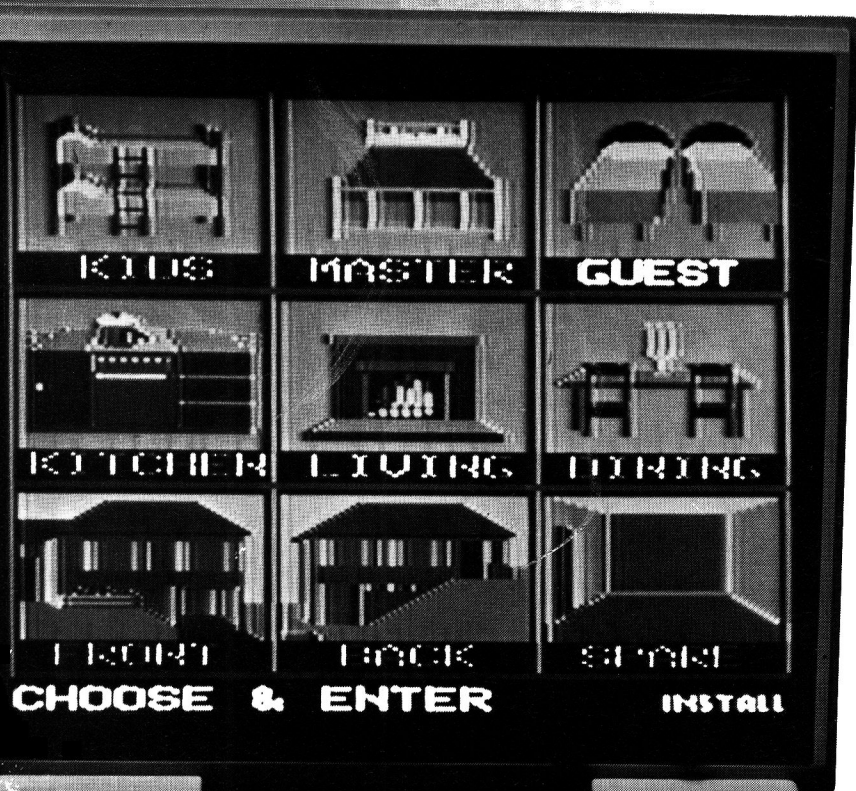

THE X-10 POWERHOUSE INTERFACES WITH YOUR APPLE TO CONTROL YOUR HOME...FOR SECURITY, COMFORT AND ENERGY SAVINGS.

This remarkable interface lets you run your home through your Apple IIc or IIe and a mouse, keyboard or joystick.

When you're away, it makes your home look lived in. When you're home, it can turn off the TV at night and wake you up to stereo and fresh brewed coffee in the morning. It can even turn on your air conditioner and control your heating.

SPECIAL COLOR GRAPHICS MAKE PROGRAMMING A SNAP. You simply pick a room from the display screen. Use your mouse or joystick to position graphics of lights or appliances. Then follow on-screen instructions to program any light or appliance to go on or off whenever you choose. You can even control thermostats, light intensity and more.

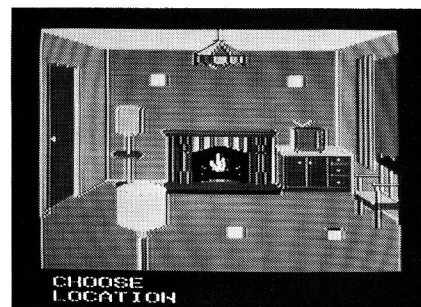

IT WON'T TIE UP YOUR COMPUTER. Use your computer only for programming. When you're finished, disconnect the interface, and use it anywhere in the house as a stand-alone controller with battery back-up. Your home will run automatically. The interface plugs into any 110V outlet, and sends digitally encoded signals through your house wiring. Installation is simple; just plug the lamp or appliance you want to control into an X-10 module. No special wiring is needed. The interface can control up to 256 modules. X-10 modules are supplied separately to work with 110V and 220V circuits.

SURPRISINGLY INEXPENSIVE. A complete Powerhouse system including the interface, software and connecting cables costs less than \$150.00 but you'll get an immediate payback in home security, comfort and energy savings.

The X-10 Powerhouse Apple interface is available now at leading computer dealers and a Commodore 64 interface is coming soon.

Apple, Apple IIc and Apple IIe are registered trademarks of Apple Computer, Inc. Commodore 64 is a registered trademark of Commodore Int'l, Ltd.



X-10[®] POWERHOUSE
NUMBER ONE IN HOME CONTROL

FOR THE X-10 POWERHOUSE DEALER NEAREST YOU,
CALL TOLL-FREE:

1-800 526-0027

NEW JERSEY RESIDENTS CALL (201) 784-9700

inCider... your integrated approach to Apple computing.



Having all the essential hardware and software does not necessarily add up to a complete home Apple* system. To make your system whole, you need information to guide you through the complexities of home computing. **inCider** will pull it all together for you.

Child's Play gives you fun programs to introduce your children to computing.

The Glau Report is head to head software evaluations for your business applications.

The Applesoft Adviser guides you step-by-step through BASIC, so you'll program better.

The Apple Clinic saves you money with answers to your maintenance and repair questions.

Hard-hitting reviews help you make every purchase a sound investment.

Plus, you'll get the latest games...
new product descriptions...utilities
...and programming tips.

**Subscribe today
and save 30% off
the cover price.**

One year of **inCider**... twelve big issues... is only \$24.97. That's a savings of 30% off the newsstand price. Just fill out the coupon and return it today with payment enclosed.

To get your first issue faster, call toll free:

1 (800) 258-5473

(In New Hampshire, call 1-924-9471).

Your money-back guarantee: You can cancel your subscription at any time. We'll reimburse you for all undelivered issues—no questions asked.

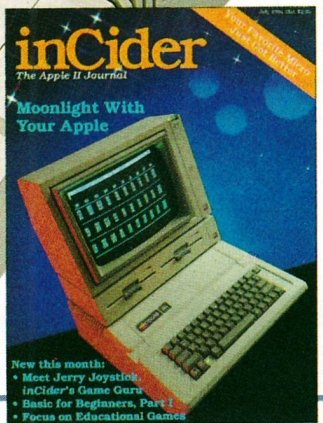

YES! I want to accomplish more!

Send me 12 issues of **inCider** for \$24.97. I'll save 30% off the newsstand price.

Payment Enclosed Bill me \$24.97

Name _____

Address _____

City _____ State _____ Zip _____

Canada and Mexico \$27.97, 1 year only, US funds drawn on US bank. Foreign surface \$44.97, 1 year only, US funds drawn on US bank. Please allow 6-8 weeks for delivery. Foreign airmail please inquire.

inCider's Ratings

Superlative ★ ★ ★ ★

Above average ★ ★ ★

Good ★ ★

Not recommended ★

Stay away ☆

Juki Model 6000

Juki Office Machine

23844 Hawthorne Boulevard, Suite 101
Torrance, CA 90503

Letter-quality printer
Any Apple II
\$300

★ ★

If, as Shakespeare said, "they stumble that run fast," the Juki 6000 letter-quality printer should provide years of particularly reliable service. The Juki 6000 is a Centronics parallel or RS-232C serial daisy-wheel machine, and it's compatible with all Apple II computers. It runs more slowly than any other printer I've seen, and its manual reads like an algebra textbook, but it does have some redeeming qualities—excellent letter-quality type and a relatively low price.

The Juki lacks a built-in buffer, which would have been a nice feature. A buffer would compensate for the printer's slow speed, allowing you to print a page without tying up the computer. The tiny Juki is only useful for printing short documents (one or two pages). At ten characters per second (the Juki's maximum speed), printing three full pages of text can take up to 20 minutes. Because of this limitation, I wouldn't recommend the Juki for business applications. It's practical only for the home user who already has a dot-matrix printer and needs just an occasional letter-quality document.

The daisy wheel has a standard American character set, with 100 numbers, letters, and punctuation marks. The wheel is flimsy and doesn't look as if it would fare well with prolonged periods of full operation. The carriage can accept paper up to 12 inches

wide; maximum line length is 9 inches, preventing the use of extra-wide paper.

In addition, the Juki uses a friction-feed paper-draw system, with no provision for installing a tractor feed; you can't print more than one page at a time. I guess my tractor-fed, correspondence-quality, 100-character-per-second dot-matrix printer has spoiled me.

The Juki is flexible in terms of number of characters per line—90 if you choose ten characters per inch, 108 if you adjust the pitch to 12 cpi. You can easily turn this feature on and off with control characters.

The 6000's ribbon—either a one-time fabric or a multiple-strike film ribbon—comes in a convenient cartridge. The ribbon system is right on top of the print head, so changing ribbons in the middle of a printing cycle is easy.

The Juki's capacity for printing copies is poor—only an original and one copy are possible. This factor limits your production, especially if you need documents printed in triplicate.

At 6 kilograms, the Juki is light and easy to handle. It's one of the more compact letter-quality printers I've seen—just 41 by 22.9 by 13.8 centimeters, ideal for a small work space.

The little Juki 6000 turns out letter quality at a low price.



If You Have
APPLEWORKS™
 It's Easy To Tell If You
 Have A Timemaster H.O. Clock
 In Your Apple

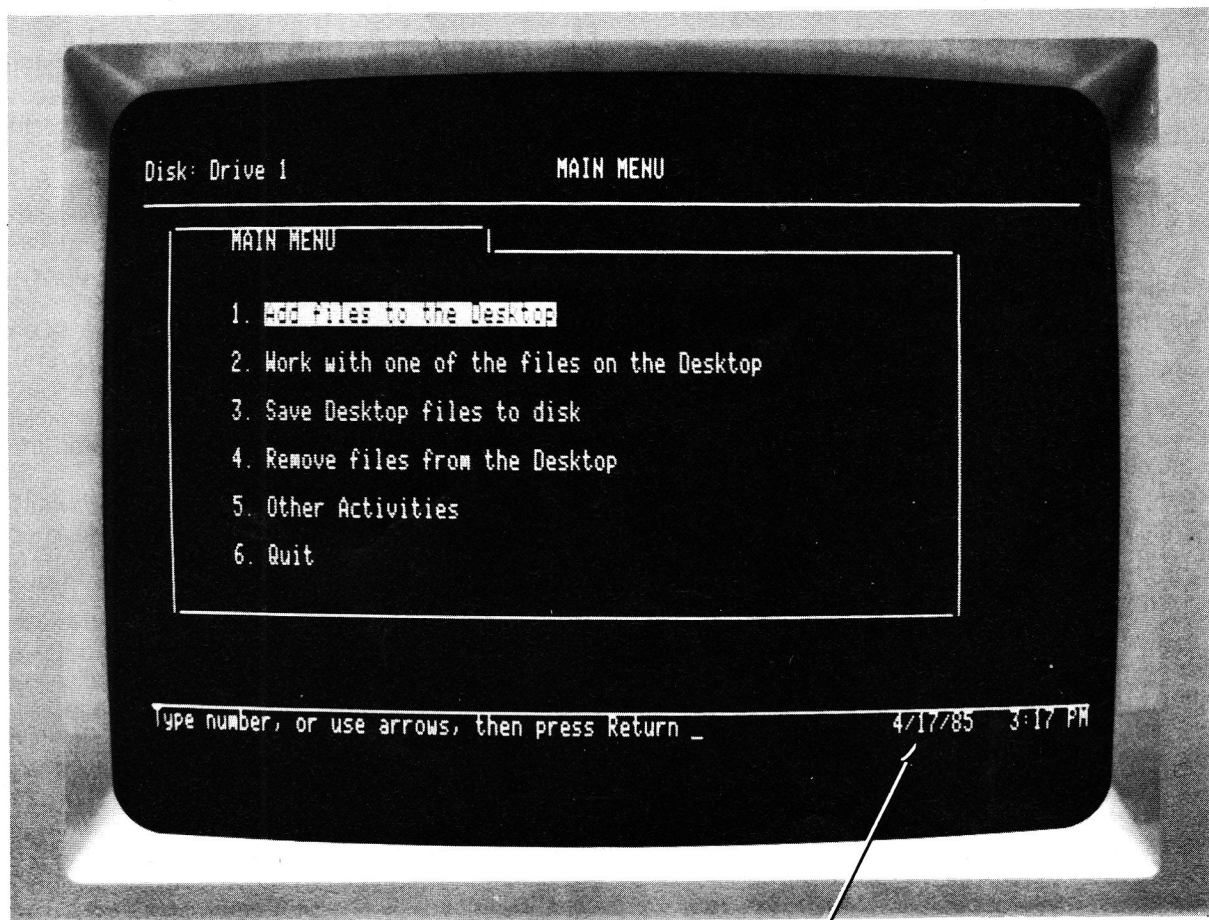

Just Look Right Here

Only the Timemaster H.O. displays the date and time on the Appleworks screen.* If you don't have a Timemaster H.O., you'll just get the help key reminder. The Timemaster H.O. will also automatically time and date stamp your files on disk. And don't forget, the Timemaster H.O. has all the features of all the competition combined, including year, leap year (not just in PRO-DOS), month, date, day, hours, minutes, seconds and milliseconds. The Timemaster H.O. is compatible with PRO-DOS, DOS 3.3, PASCAL and CP/M. And the Timemaster H.O. automatically emulates all other clock cards so you won't have any compatibility problems because the Timemaster H.O. works with ANY program that reads ANY clock.

In fact, you could put ALL the competitive cards in every slot in your Apple and you still wouldn't have all the features of the Timemaster H.O.

The Timemaster H.O. comes with a ton of fun and useful software. It has an easy to read yet detailed manual, a 20 year auto-recharging battery and a 3 year no hassle warranty.

TIMEMASTER H.O.

SIMPLY PUT,

IT'S SIMPLY THE BEST

\$129.00 Complete

*If you purchased a Timemaster H.O. prior to AppleWorks support, an easy to use patch program is available for \$20.00.



Call (214) 241-6060 9 a.m. to 11 p.m., 7 days a week or
 Send check or money order
 P. O. Box 798
 Carrollton, Texas 75006



MasterCard, Visa and C.O.D. welcome. No extra charge for credit cards.

Texas residents add 5½% sales tax.

Add \$10.00 if outside U.S.A.

The Juki 6000 is an inexpensive printer with outstanding type quality. It's unusually quiet, even with no built-in sound insulation, but it will never win any awards for speed. All in all, though—if you're not looking for a high-production printer—the Juki 6000 is a sure-footed winner. ■

Joseph J. Lazzaro
Revere, MA

Prolmage

Interactive Arts
2715 Porter Street
Soquel, CA 95073

Animation design
Any Apple II, 64K
\$69.95

★ ★

Shape tables, machine language, decimal-to-hex conversion—the details of program animation can be sheer drudgery. The right software can take care of the more laborious tasks of your animation project, but Prolmage is one package that leaves you with a great deal of the work. Prolmage lets you create smooth, professional-looking animation with images you design with the program or borrow from another source. There are so many steps in this process, and so much Applesoft programming to fiddle with, however, that only dedicated animators will be likely to persevere long enough to see their work on the screen. For those who do, however, the results are worth the effort.

At least three techniques let you animate an image on a cathode-ray tube. The first method, and the most time-consuming, is to draw an image, erase it, then redraw it elsewhere. Another way is to use the XOR (exclusive or) drawing mode, which redraws the image over itself. It's slow, but it permits drawing over complex backgrounds. Prolmage employs a third method, pre-shifted images: You draw an image, save it, shift it to a new location, and save it again under a different name. You repeat the process until you've drawn an entire series of pre-shifted images over one another in sequence to create the illusion of movement. Animation produced by pre-shifted images is smooth and fast.

I tested the ProDOS version of Prolmage (DOS 3.3 is also available). The package contains one disk and an 81-page typewritten manual in a three-ring binder. Booting the disk takes you to the main menu, where you can choose from PIXED (the pixel editor), TABLE (to arrange into the proper display sequence images you've already shifted and saved), CONFIGURATION (the type and number of disk drives you're using and your printer-card slot),

DEMO (a self-running illustration of Prolmage animation), and BASIC, which exits the program.

Editing Pixels

PIXED is somewhat limited as a graphics editor, and it's hardly what I'd call user-friendly. The screen is blank, except for the command line (PLCBSUZ-FEQVHRTJKKIM) and the status line (X=1 Y=1 HB=38 VB=190 S=1) at the bottom. The letters in the command line denote specific functions (see the accompanying **Table**). The status line displays the x and y coordinates of your current screen position, the horizontal and vertical block dimensions, and the current step size for cursor movement.

Despite its lengthy command list, PIXED lacks several vital features. For example, you can't draw circles and curves except by plotting them one pixel at a time, and you can't rotate or change the size of your image. One way around the latter problem is to create your graphics with another program and save it as a standard 33- or 34-sector binary file. (Make sure you add .PIC to the file name so that Prolmage will recognize it as a picture.)

If you've drawn an automobile, and you want to begin one of your programs by making the image travel across the screen, use the PIXED file command to load and display the picture. Next, create a block slightly wider than the image, and move the image into the block with the V command and the arrow keys. Be sure to leave the leftmost (vertical) columns of pixels blank. Now save the image as AUTO1. Move the image two pixels to the right and save it as AUTO2. Continue shifting and saving until you reach the right edge of the block. As these images are drawn over one another, the blank pixels erase the leftmost portion of the previous image, and the automobile appears to move from left to right.*

Computer Cartoons

Arranging the images in their proper order requires Prolmage's TABLE program. Once you load it into memory, the program displays the appropriate image directory so that you can determine the order of presentation. When you're satisfied with the arrangement, press the return key to build the shape table. The program then prompts you for a table name. If your ProDOS data disk has the prefix /DATA, enter /DATA/TABLES/AUTO. With the DOS 3.3 version, simply type AUTO.

After you've constructed an image table, you can incorporate it into any program. Prolmage supplies two programs to illustrate this procedure—BASKEL (Basic Skeleton), an Applesoft file that loads the shape table, and IMGASSY (Image Assembly), a binary file that does the drawing. The manual includes a tutorial showing the program lines you must modify to move a sample image across the screen. The tutorial (and the rest of the manual) is so riddled with typographical errors, however, that trying to understand it is quite frustrating. When I finally got

Designed For Those Who Only Accept The Best!

TIMEMASTER II H.O.™

- Absolutely, positively, totally PRO-DOS and DOS 3.3 compatible.
- Time in hours, minutes, seconds and milliseconds (the ONLY PRO-DOS compatible card with millisecond capability).
- 24 hour military format or 12 hour with AM/PM format.
- Date with year, month, day of week and leap year.
- Eight software controlled interrupts so you can run two programs at the same time (many examples are included).
- The only card recognized by both the DOS 3.3 and PRO-DOS versions of Apple Writer IIe.
- Appleworks will now time and date stamp all your data automatically.
- The only clock card that will display the time and date on the Appleworks screen.
- Compatible with ALL of Apple's languages. Many sample programs for machine code, Applesoft, CP/M and Pascal on 2 disks.
- On-board timer lets you time any interval up to 48 days long down to the nearest millisecond.
- Auto-recharging nickle-cadmium battery will last over 20 years.
- Two BSR/serial ports for future expansion.

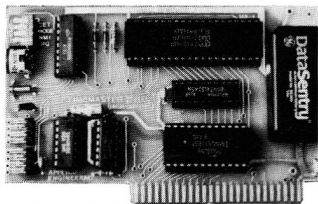

H.O.	PRO-DOS COMPATIBLE	INCLUDES DOS DATER	MILLISECOND TIME	YEAR DATA	LARGEST SAMPLE SOFTWARE	REMOTE SET PORT	BSR PORT	EMULATES ALL OTHER CLOCKS
H.O.	YES	YES	YES	YES	YES	YES	YES	YES
BRAND A	NO	NO	YES	NO	NO	NO	NO	NO
BRAND C	NO	NO	NO	NO	NO	NO	NO	NO
BRAND M	NO	NO	NO	NO	NO	NO	NO	NO
BRAND P	YES	YES	NO	YES	NO	NO	NO	NO
BRAND S	NO	NO	NO	YES	NO	NO	NO	NO
BRAND T	YES	NO	NO	NO	NO	NO	YES	NO

Full emulation of all other clocks. Yes, we emulate Brand A, Brand T, Brand P, Brand C, Brand S and Brand M too. It's easy for the H.O. to emulate other clocks, we just drop off features. That's why the H.O. can emulate others, but none of the others emulate us. The Timemaster II H.O. will automatically emulate the correct clock card for the software you're using. Of course most programs will use the Timemaster II H.O. in its native mode, but it's comforting to know that you won't have to worry about compatibility problems. You can also give the H.O. a simple command to tell it which clock to emulate. This is great for writing programs for those poor unfortunates who bought some other clock card.

REMOTE CONTROL

Our BSR X-10 interface option for the H.O. allows you to remotely control up to 16 lights and electrical appliances through your BSR X-10 home control system in your home or office. You're already wired because a BSR system sends its signals over regular 120 volt wiring. That means you can control any electrical device in your home or office without additional wiring.

CLOCK PRICE \$129.00 BSR Option (may be added later) \$49.00

VIEWMASTER 80™

There used to be about a dozen 80 column cards for the Apple. Now there is only ONE.

- TOTALLY Videx Compatible.
- Perfect for any APPLE II, II+ or IIe.
- 80 characters by 24 lines, with a sharp 7x9 dot matrix.
- On-board 40/80 soft video switch with manual 40 column override.
- Fully compatible with ALL Apple languages and software—there are NO exceptions.
- Low power consumption through the use of CMOS devices.
- All connections are made with standard video connections.
- Both upper and lower characters are standard, with true descenders.
- All new design (using a new Microprocessor-based C.R.T. controller) for a beautiful razor sharp display.
- The VIEWMASTER incorporates all the features of all other 80 column cards, plus many new improvements.

	PRICE	BUILT-IN SOFTSWITCH	LOW POWER DESIGN	80 COLUMN HOME	7X9 DOT MATRIX	LIGHT PEN INPUTS	40 COLUMN OVERRIDE	INVERSE CHARACTERS
VIEWMASTER	139	YES	YES	YES	YES	YES	YES	YES
SUPRTERM	MORE	NO	NO	NO	NO	NO	YES	YES
WIZARD 80	MORE	NO	NO	NO	YES	NO	YES	YES
VISION 80	MORE	YES	NO	NO	YES	NO	NO	NO
OMNIVISION	MORE	NO	NO	NO	NO	NO	YES	YES
VIEWMAX 80	MORE	YES	NO	NO	YES	NO	NO	YES
SMARTERM	MORE	YES	NO	NO	NO	YES	YES	NO
VIDEOTERM	MORE	NO	YES	NO	YES	YES	NO	YES

The VIEWMASTER 80 works with all 80 column applications including CP/M, Pascal, WordStar, Format II, Easywriter, Apple Writer II, VisiCalc, Dollars and Sense, and all others. The VIEWMASTER 80 is THE MOST compatible 80 column card you can buy at ANY price!

PRICE \$139.00

Z-80 PLUS™

Now Includes New 4.0™ Software

Enter the CP/M world with the new Z-80 Plus card from Applied Engineering and introduce your Apple to thousands of new programs. Only the Z-80 Plus comes standard with the new 4.0 software, the most advanced system for running CP/M programs ever. Only CP/AM 4.0™ has advanced features like built-in disk emulation for popular memory expansion boards (those made by Apple and Applied Engineering and others) to give you a faster system with more storage. You also get menu driven utilities that are much easier to use than the older CP/M utilities so you can get down to all that great CP/M software faster. The Z-80 Plus runs older CP/M programs too, down to Version 1.6 (2.2 is the most popular). With the Z-80 Plus you can run the largest body of software in existence, and the Z-80+ is the only card on the market capable of accessing more than 64K in an Apple IIe. If you have an extended 80 column card, all 128K is usable, and if you have Ramworks, up to 1088K is available to CP/M. And each Z-80+ includes our CP/M Ram Drive software, enabling IIe owners to use an extended 80 column card, or a Ramworks card as an ultra-fast Ram disk enabling CP/M software to run 10 to 20 times faster. So fast acting software like WordStar, and dBASE II become virtually instantaneous! Simply plug the Z-80 Plus into any slot in your Apple. You'll have two computers in one and the advantages of both, all at an unbelievably low price.

- TOTALLY compatible with ALL CP/M software.
 - Fully compatible with most hard disks including the Sider and Corvus.
 - The only Z-80 card with a special 2K "CP/M detector" chip.
 - Fully compatible with microsoft disks (no pre-boot required).
 - Specifically designed for high speed operation in the Apple IIe (runs just as fast in the II+ and Franklin).
 - Runs WordStar, dBASE II, Turbo Pascal, Fortran-80, Peachtree and ALL other CP/M software with no pre-boot.
 - A semi-custom I.C. and low parts count allows the Z-80 Plus to fly through CP/M programs at a very low power level. (We use the Z-80B at a fast 4MHZ.)
 - Does EVERYTHING the other Z-80 boards do, plus Z-80 interrupts.
- PRICE \$139.00**

Our boards are far superior to most of the consumer electronics made today. All I.C.'s are in high quality sockets with mil-spec. components used throughout. P.C. boards are glass-epoxy with gold contacts. Made in America to be the best in the world. All products work in Apple IIe, II, II+ and Franklin. Applied Engineering also manufactures a full line of data acquisition and control products for the Apple; A/D converters and digital I/O cards, etc. Please call for more information. All our products are fully tested with complete documentation and available for immediate delivery. All products are guaranteed with a no hassle **THREE YEAR WARRANTY.**

Call (214) 241-6060, 9 a.m. to 11 p.m. 7 days a week or send check or money order to

P.O. Box 798, Carrollton, Texas 75006. MasterCard, Visa and C.O.D. welcome. No extra charge for credit cards. Texas residents add 5% sales tax. Add \$10.00 if outside U.S.A.

AE
APPLIED ENGINEERING
"We Set the Standard!"

Back Issues

January 1984: 11 cottage industries, Poster printer, Using Pascal, Game port modification, "Jigsaw Puzzle"

February 1984: Apples and solar energy, Environmental control and design, Classy computer music, "Serpent," Combine MBasic and machine language

March 1984: Macintosh sneak preview, Lisa 2, "Starfrog and Flutterbye," "Presidential Power," Pascal, "Shogun"

April 1984: Apples and Olympic athletes, "Softball Statistics," "Ten Pin Tally," "Golf Slice II," "Design Maker," VisiCalc Tax Preparation, "Clearmem," "Builder"

May 1984: Interview with Bill Budge, "Flashcards," ASCII tutorial, Creating 35 mm slides, "Stack Attack," "Pascal word processor," "Baby's First Program"

June 1984: Choosing a letter-quality printer, Apple Writer utility, Budget analysis, "Ultima III Character Generator," "Scout Search," Stepper motor interface

July 1984: Introducing the //c, Interview with Steve Wozniak, Pick the right software for your kids, Russian word processor, "Piano Keys," AppleWorks reviewed, "Munch Mouse"

August 1984: How to buy a modem, Directory of modems, "Grape Gobbler," //c vs PCjr, Apple modem reviewed, Early childhood software, "Joysticking"

September 1984: "Hypnosis," "Talk to Me," Apples in Education, SuperPILOT, "Instant Alphabet," Gameport interfacing, "Typing Defense"

October 1984: Apples in business, Choosing business software, Sales leads on disk, "Pie Charts," "Letterhead Creator," Guide to Mouse Software, "KidWord"

November 1984: Top 40 games of all time, Wizardry, "Saving Graphics Screens," "Fast Tracks," Free Data Bases, Apples in Politics, "Dino Math"

December 1984: Holiday gift guide, Apple poker, "MousePaint Printer Dump," "Wundersheet," "Random Music," "Trim an Apple Tree," Spreadsheets reviewed

In each back issue you'll also find our regular features, including reviews of important new software and hardware. Also, advice on business applications and programming from our nationally recognized team of columnists.

Each back issue costs \$3.50 plus \$1 shipping and handling. On orders of ten or more back issues, there is a flat \$7.50 shipping and handling fee. Quantities are limited so some issues may not be available. Send your orders to *inCider*, Attn.: Back-Issue Orders, 80 Pine Street, Peterborough, NH 03458.

Articles set off by quotation marks are published complete with type in program listings.

REVIEWS

Table. Prolmage commands.

Command Letter	Function
P	Plots a point at the current cursor location
C	Lets you select any one of eight standard Apple hi-res colors
B	Sets the size of the block or image window
S	Changes the cursor-movement step size
U	"Unplots" a point at the cursor
Z	Erases the line from the last plotted point to the cursor
F	Takes you to the filer menu where you can save or load shapes and pictures, catalog, or execute any ProDOS command
E	Erases the screen and restores block and step defaults
Q	Exits PIXED
V	Lets you move the image around the screen with the J, K, I, and M keys
H	Takes you to help screens listing these commands
R	Toggles between full and split-screen graphics
T	Activates the text mode so that you can write on your graphics with standard ASCII characters

things straightened out, the image I created did move smoothly and rapidly across the screen, so the system does work.

Prolmage provides an interesting, though somewhat limited, introduction to computer animation techniques. For programmers motivated enough to make the effort, this might be the place to start. If you don't want to spend a lot of time with AppleSoft, however, I'd advise you to stay away. ■

Wayne Sassano
Wethersfield, CT

Mouse Calc

International Solutions

910 West Maude Avenue
Sunnyvale, CA 94086

Spreadsheet
Apple //c or //e, 128K
\$149

★ ★ ★ ★

A new French connection is infiltrating the United States—a wave of Mac-like software beginning with Mouse Calc, a smoothly integrated spreadsheet and graphics program.

AlphaChart!

Mouse Calc, the creation of 23-year-old French programmer Luc Barthelet, is reported to be to the //c what the original VisiCalc was to the Apple II. When you experience (a word not chosen lightly) Mouse Calc, you will see how far spreadsheets have come in less than ten years.

Many fine features distinguish Mouse Calc from other members of the Apple II calc family, yet the basics have not been overlooked. Mouse Calc performs all the routine spreadsheet functions. In fact, Mouse Calc can do almost anything VisiCalc Advanced can do. It even protects and hides formulas and merges spreadsheets.

The most frequently used mathematical and logical functions are built in. The more esoteric accounting functions (net present value and internal rate of return), however, are not preprogrammed for you.

I found it ironic that even when translated, this French-born program uses English in a common-sense way that some American-made software does not. For example, you don't "replicate"—you "copy" and "paste."

The most obvious distinction between Mouse Calc and other spreadsheet programs, however, is the appearance of its screen. The others present you with a rather static grid of cells. What you do with those cells is determined by how persistently you studied the program manual. If you don't remember their multifarious commands, you get beeped, and you get discouraged. You pray for something like Mouse Calc to come along.

Sure, It's a Spreadsheet

Sure, Mouse Calc has a grid of cells. It also has columns, rows, and a cursor. It wouldn't be a spreadsheet without those. But Mouse Calc is as much "mouse" as it is "calc." The program takes full advantage of this unique input device, so you don't have to use arrow keys or the GoTo function to move around the spreadsheet. Move the mouse instead.

You don't have to memorize a single command, because the masthead above the spreadsheet grid is your menu. Here your main options are logically presented; File, Edit, Print, Function, Format, Graph, Calculate, Link, and Info commands are included. To access any sub-options, move the on-screen pointer to the main option and click the mouse button. A pull-down menu unrolls before you. Move the mouse to your selection, click again, and you're center-justifying, for example, without even trying.

Mouse Calc's pull-down menus offer nearly 100 options. Without a doubt, this system beats even the best-conceived mnemonic command structure. You'll never need to CTRL or slash anything again.

The promotional material with the package claims that having Mouse Calc is "like having a Macintosh

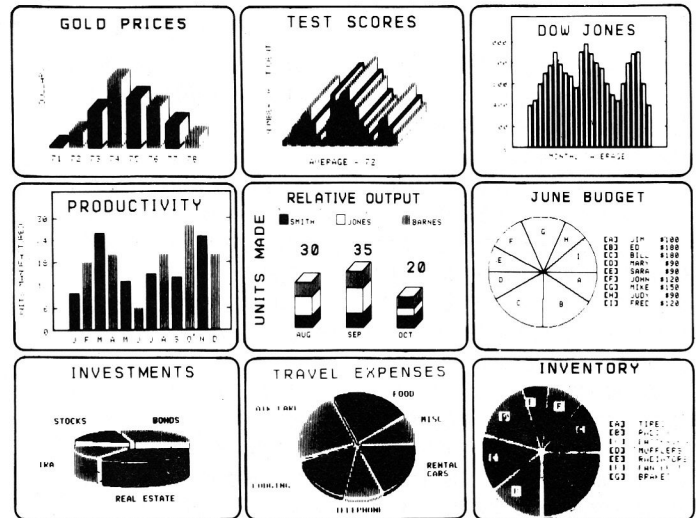

Don't pay more for less! The pictures shown above are examples of charts created with AlphaChart!, perhaps the most powerful and friendly Apple II chart program on the market. Within seconds, keyboard-entered data can be converted into picture-perfect pie or bar charts, in 26 user-selectable styles, automatically scaled and labeled, and in color or black and white. And if you want to customize your charts by adding extra artwork or text, or display them in a slide show, AlphaChart! comes with these valuable extras

A slide projector, for orchestrating automated, stand-alone screen presentations of a series of charts, timed and sequenced by the user. This program alone is worth the cost of the disk. It can be used with any graphics files created with any program.

A graphics editor, for alteration and embellishment of charts. Besides standard point-by-point sketching, built-in structures permit push-button creation of circles, rectangles, lines, shape-table shapes, and exotic woven plaid patterns. If you wish to add clarifying text to the charts, you may type on the screen in several different letter font styles. For the artist, the graphics editor can also be used to sketch any imaginable scene from scratch.

A shape table editor, for creating special shapes for your charts. These shapes can also be used for animation in your programs! A sample animation program shows how to do it.

AlphaChart! includes a screen-dump program for printing your charts on paper. AlphaChart! is more! Just read what these people have to say about it . . .

"I noticed the advertisements for Spectral Graphics' AlphaChart! program and figured that, with a money-back guarantee, I would try it. Boy, am I glad I did! This is a fantastic program. You can master its many varied capabilities in less time that it would take to describe them. I would recommend it to everyone, even if you have absolutely no need for a graphing program. It's just fun to play with." S.A. Smith, San Bernadino, Calif. . . letter to SOFTALK, June, 1984, page 14.

"The software does much more than the advertisement suggests. Without question, this is among the best buys in software that I have ever come across, and certainly among the best written. It is extraordinarily easy to use, very well thought out, and priced to kill your competition (which I wish you every success in doing)." Anthony J. Scriffignano, North Caldwell, New Jersey.

"I have long been distressed by the lack of software available in the scientific academic community. At last there is a simple yet robust graphics program applicable for our purposes: AlphaChart!, by Spectral Graphics Software. Business folks and scientists alike will really appreciate how user-friendly it is; I was able to produce my first three-dimensional, multi-colored, labeled bar graph within five minutes of booting the disk—without reading my documentation. I would have had to pay a scientific illustrator much more than the whole program costs just to produce that one graph. . . . you can't do without this gem." John B. Iverson, Richmond, Indiana. . . letter to SOFTALK, April, 1984, page 23.

ONLY \$29.95 Apple II + //e//lc. Satisfaction guarantee or your money back (really!). Send a check or purchase order to **SPECTRAL GRAPHICS SOFTWARE**, 6333 Pacific Avenue, Dept. 256C, Stockton, California 95207. C.O.D. orders call toll free 1-800-826-2989. In California call 1-800-231-7316.

Circle 38 on Reader Service Card.

in your Apple II." The truth is even better than that. Apple II users have something Mac owners don't have—color. And with Mouse Calc, you have double-hi-res color.

Turning any part of your spreadsheet into crisply colored bar or line charts is as simple as highlighting the chosen data, opening a window (vertical or horizontal), and selecting the Graph option. With a click of the mouse button, you can instantly make your bar charts three-dimensional for a pleasing, professional effect.

What do you pay for all this? Aside from the monetary cost of \$149, you pay another price—memory usage. Mouse Calc comes on one program disk (back-up and sample file disks are also included). The main program, including graphics utilities, loads in one shot, leaving 42K remaining from an initial 128K.

For most personal-computing uses, that amount of memory should suffice. For instance, I was able to track one month's income and expenses for five rental properties I own. My spreadsheet used about 110 cells, 21 of which held formulas. Using an additional 2K of memory, I also prepared a 3-D bar graph showing eight parameters for my five houses (40 bars in eight different colors).

Business users should be aware that completely filling 2171, or about 1/7, of the available cells exhausts the computer's memory. Still, when you consider that VisiCalc Advanced leaves you only 69K of working memory and doesn't offer the ease of use or color graphics Mouse Calc provides, you may conclude, as I have, that the extra 27K Mouse Calc costs you is memory well spent.

Printing with Mouse Calc

Printing your work is easy as un, deux, trois. From the pull-down Print menu, you can choose to print the spreadsheet only, the graph only, the spreadsheet and graph, or the whole screen display. When printing a spreadsheet, you have sufficient formatting capabilities, including page length and width. You can also program your printer for condensed or other typestyles.

Mouse Calc remembers the top-left and bottom-right limits of your spreadsheet, so you don't have to be sure the cursor is on cell A1 before you print. If you want to print only part of your work, however, you can easily change the default settings. Since Mouse Calc can read and write DIF files, you can convert from VisiCalc or AppleWorks without losing data.

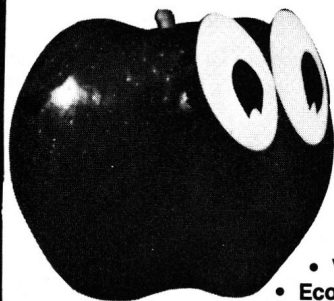

LET YOUR APPLE SEE THE WORLD!

The DS-65 Digisector® opens up a whole new world for your Apple II. Your computer can now be a part of the action, taking pictures to amuse your friends, watching your house while you're away, taking computer portraits . . . the applications abound! The DS-65 is a random access video digitizer. It converts a TV camera's output into digital information your computer can process. The DS-65 features:

- **High Resolution** — a 256 × 256 picture element scan
- **Precision** — 64 levels of grey scale
- **Versatility** — Accepts either NTSC or industrial video input
- **Economy** — A professional tool priced for the hobbyist

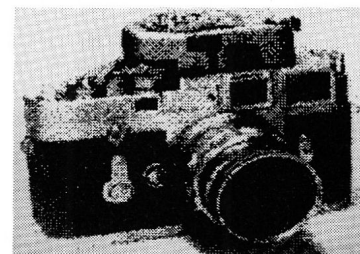

HI-RES PICTURE USING THE DS-65 AND PICTURE SCANNER SOFTWARE

The DS-65 is an intelligent peripheral card with on-board software in 2708 EPROM. Check these software features:

- Full screen scans directly to Apple Hi-Res screen
- Easy random access digitizing by Basic programs
- Line-scan digitizing for reading charts or tracking objects
- Utility functions for clearing and copying the Hi-Res screen

Use the DS-65 for precision security systems; computer portraiture; robotics; fast to slow scan conversion; moving target indicators; reading UPC codes, musical scores and paper tape and more! **GIVE YOUR APPLE THE GIFT OF SIGHT!** DS-65 Price: \$349.95 RCA 1500 Series Camera w/6:1 zoom lens Price: \$399.90/Combination Price: \$729.95

ADDITIONAL SOFTWARE FOR THE DS-65

— **Picture Scanner:** An applications tool for processing video images for display on the Hi-Res screen. A variety of dithering algorithms are provided, for compressing the digitized image into the Hi-Res screen and simulating grey scales. Price: \$39.95

— **Superscan:** Enables you to enhance the DS-65's Hi-Res pictures with colors! Choose from 21 different colors and assign them to grey scale values, modify pictures, zoom, enhance contrast, etc. Includes print routines for Anadex 9500 or 9501; Epson MX-80GFT and MX-100; and IDS 460 Paper Tiger*. Written for The Micro Works by Magna Soft. Price: \$99.95

*Paper Tiger is a trademark of Integral Data Systems, Inc.

THE **MICRO
WORKS**

Now for IBM PC!

California Residents add 6% Tax

Mastercard/Visa Accepted

P.O. BOX 1110 DEL MAR, CA 92014 619-942-2400

International Solutions, the American marketing firm for Version Soft, promises a soon-to-be-released word processor called Mouse Word, purported to integrate with Mouse Calc, and Mouse Budget, for tracking personal finances. (At press time, International Solutions claimed to be shipping Mouse Word and Mouse Budget, and to be creating Mouse Desk.—eds.)

As with any other program in its first release, this version of Mouse Calc did have a few problems. The program disk didn't load consistently in my //e and //c. Sometimes the screen froze when I tried to use the elevators or copy and paste. According to a very supportive spokesman at International Solutions, some master disks may have been X-rayed in transit. When I switched to the back-up disk, I had no further problems.

Other minor annoyances can't be blamed on the medium. For example, you should be able to label the axes of graphs with descriptive words. On my rental-property graph, for example, I numbered the bars 1 through 5. And, if you discover a mistake while printing, you should be able to stop the printing process by pressing the escape key.

These are fairly tepid criticisms, however. Mouse Calc for the Apple //c and //e is the crème de la crème.■

Cynthia E. Field
Wakefield, RI

The Cari Portable Powered Work Station

Discwasher

1407 North Providence Road
P.O. Box 6021
Columbia, MO 65205

Portable power supply and carrying case
Apple //c
\$249.95

★ ★

Looks can be deceiving. At first glance, Discwasher's gray-and-black case may resemble a stylish overnighter. But once you open it, you'll discover the perfect solution for your traveling computer needs—the Cari Portable Powered Work Station, a rechargeable battery system that makes the //c truly portable.

RAMWORKS™

**ACCEPT NO SUBSTITUTES.
BECAUSE THERE AREN'T ANY.**

There's only one card like RamWorks. We've got the best hardware design. We supply the best software and we've got the best support from software companies.

If someone tempts you with an imitation, please get both sides of the story. You'll discover why RamWorks offers the best enhancements to AppleWorks and other programs, and at the lowest price.

GUARANTEED!

**214-241-6060
9 AM - 11 PM**



**"We Set the Standard"
APPLIED ENGINEERING**



The good-looking Cari Portable Powered Work Station.

Constructed of tough, water-repellent cordura nylon, the Cari case is well prepared for rigorous travel. Measuring 20 by 13 by 6 inches, it easily fits under airline seats.

A high-density foam support system protects the internal elements of this portable power supply. The unit provides ample room for toting the //c power-transformer cube, a modem, a printer-interface cable, or other small items, along with your computer, flat-panel display, and buffer box. The weight of all that equipment adds up, however—you won't want to tote the Cari around for long when it's full.

Power Hitter

Velcro straps hold the Cari's rechargeable power source, a sealed lead-acid gel cell; you can remove the power source from the Cari case for desktop use. Two short cables with DIN connectors, one male and one female, extend from the front panel of the gel cell. This panel also houses the on-off switch and piezo buzzer, which indicates low power. Since the power cell, which contains a 5-amp fuse, is sealed, you'll have to contact Discwasher or an authorized service center when the battery needs repairs.

One of the DIN connectors goes into the //c's power socket. The transformer-cube power jack matches the remaining DIN connector of the battery. The transformer cube fits inside the Cari case so that you can recharge the cell while traveling. Discwasher advises you to leave the //c power switch in the "on" position at all times and use only the battery power switch for turn-on, turn-off chores because the //c drains electricity—even when the computer's switch is off.

Extending Life Expectancy

According to Discwasher, the battery's life expectancy is 400 to 500 recharge cycles (if drained low enough to activate the low-voltage alarm). As power is depleted, the low-voltage alarm will sound when you access the disk drive. If the warning sounds steadily, you have about ten minutes of power left, so save your work and recharge the unit. If you regularly recharge the battery before it runs down to alarm levels, you can extend its life expectancy to more than 1000 charges. Going from the low-voltage warning to a full charge takes 12 to 16 hours. You can leave the battery on recharge indefinitely, since you can't overcharge it. The //c transformer cube serves as the power source for recharging.

**It Talks!
It Recognizes!
It Writes Music!**
and more . . .

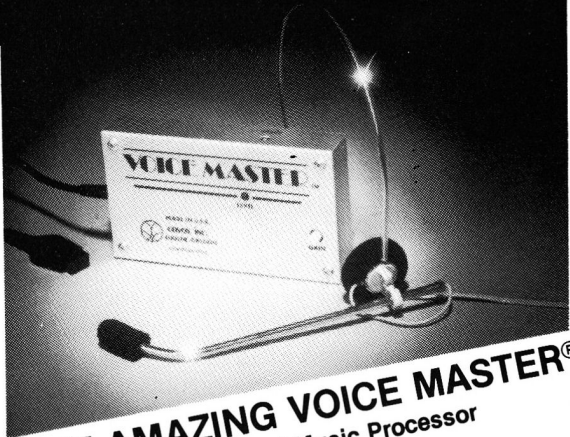

THE AMAZING VOICE MASTER®
Speech and Music Processor

Your computer can talk in your own voice. Not a synthesizer but a true digitizer that records your natural voice quality—and in any language or accent. Words and phrases can be expanded without limit from disk.

And it will understand what you say. A real word recognizer for groups of 32 words or phrases with unlimited expansion from disk memory. **Now you can have a two way conversation with your computer!**

Easy for the beginning programmer with new BASIC commands. Machine language programs and memory locations for the more experienced software author.

Exciting Music Bonus lets you hum or whistle to write and perform. Notes literally scroll by **as you hum!** Your composition can be edited, saved, and printed out. You don't have to know one note from another in order to write and compose!

Based upon new technologies invented by **COVOX**. One low price buys you the **complete system**—even a voice controlled black-jack game! In addition, you will receive a subscription to **COVOX NEWS**, a periodic newsletter about speech technology, applications, new products, up-dates, and user contributions. **You will never find a better value for your computer.**

ONLY \$89.95 includes all hardware and software.

For telephone demonstration or additional information, call (503) 342-1271. FREE audio demo tape and brochure available.

Available from your dealer or by mail. When ordering by mail add \$4.00 shipping and handling (\$10.00 for foreign, \$6.00 Canada).

The Voice Master is available for the C64, C128, all Apple II's, and Atari 800, 800XL and 130XE. Specify model when ordering.



For Faster Service on Credit Card Orders only:

ORDER TOLL FREE 1-800-523-9230



COVOX INC. (503) 342-1271
675-D Conger Street, Eugene, OR 97402
Telex 706017 (AV ALARM UD)

Here are 145 reasons to buy at Elek-Tek, not to mention the fastest delivery anywhere.

Save 30% to 43% off Manufacturer Suggested Retail prices on
EPSON • Okidata • Star
• TOSHIBA • COMREX • OLYMPIA



1. 5 meg Drive for Macintosh \$ 1375
- 1a. Cartridges for above 43
2. 10 meg Drive for IBM-PC/XT/AT & compatibles 1790
3. 20 meg Drive for IBM-PC/XT/AT & compatibles 2490
4. 10 meg Drive w/ Auto Boot for IBM-PC/XT & compatibles 1890
5. 20 meg Drive w/ Auto Boot for IBM-PC/XT & compatibles 2590
6. 10 meg cartridges for above (3 pak special) 125

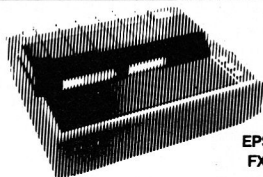

EPSON FX 85

- EPSON®**
16. LX 80 \$ 215
 17. FX 100+ 350
 18. FX 85 340
 19. FX 185 475
 20. LQ 1500 parallel CALL
 21. DX10 Daisy Wheel 10CPS 230
 22. DX20 Daisy Wheel 20CPS CALL
 23. Comrex II Comriter 269



45. SG 10 235
46. SD 10/15 CALL
47. SR 10/15 CALL



48. Oki 182 CALL
49. Oki 192/193 CALL
50. Oki 84 CALL

OTHER PRINTERS

51. Olympia Compact 2 \$ 350
52. Olympia Compact RO CALL
53. Toshiba P351 1080
54. Toshiba P1340 560

HEWLETT-PACKARD

73. HP-71B Computer \$ 399
74. HP-82400A Series 70 card reader 125
75. HP-82401A HP-IL interface 95
76. HP-82402A 4K memory module 60
77. HP-82700A 8K memory module 150
78. HP-82441A Assembly/Forth 120
79. HP-82480A HP-71 math pac 75
80. HP-82482A HP-71 finance pac 60
81. HP-82483A Surveying Pac 120
82. HP-82484A Curve Fitting 75
83. HP-82485A Text Editor 60
84. HP-82488A Data Com. Pac 120

PRINTER BUFFERS

7. DDP-16 16K Par./Par. (exp. to 64K) . . . 70

QUADRAM

8. QRMP8 8K Parallel/Parallel 125
9. QRMP58 8K Parallel/Serail 139
10. QRMS8 8K Serial/Parallel 139
11. QRMS8 8K Serial/Serail 139

POWER PROTECTORS

12. PowerMite PG600-S9 6 outlet Surge Suppressor . . . 30
13. ISOBAR 8 8 outlet Surge Suppressor . . . 50



Standby Power Systems

Protects your computer hardware and data when the power goes out.

14. 400VA (3.3A) 475
 - Transfertime—4-6 Mil. Sec.
 - Waveform—rectangular
 - Runtime—up to 24 min.
15. 1000VA 875
 - Switches to battery powered back-up in 1/2 mil. sec.
 - Clean sine wave output
 - AC line synchronized
 - Regulated output voltage
 - Surge Suppression
 - EMI/RFI filter

PRODUCTS FOR IBM-PC

24. Amdek 310A Amber Monitor \$ 150
25. Generic Multi Multifunction Board, 64K 150
26. AST Six Pak + Multifunction Board, 64K 229
27. AST Six Pak + (loaded) Multifunction Board, 384K 289
28. AST Megaplus II Multifunction Board, 64K 270
29. Quadram Quadboard Multifunction Board, 0K 195
30. Quadram Quadboard Multi. Board, 64K/384K 210/267
31. Orchid Tech. PC Turbo 186 570
32. Paradise Modular Graphics Card 275
33. Hercules Monochrome Card 329
34. Hercules Color Color Graphic Card 170
35. Novation 490605-1 2400BPS inc. Mite Software 620
36. Novation 490603 1/2 Card Modem 2400BPS No software 425
37. Novation 490603-1 As above inc. MS-DOS Software 490
38. Hayes 1200B Internal modem w/software 379
39. AT&T 4000 300/1200 Ext. Modem 335
40. Hayes 1200 External modem 399
41. Hayes 2400 External modem 599
42. US Robotics Courier 2400 Ext. 2400B Smart Modem 460
43. US Robotics Telpac Telecomm. Software 75
44. TEAC FD55B 1/2 ht. DSSD Disk Drive 90

PRODUCTS FOR APPLE

55. U—Print IIC-16K Par Interface external \$ 85
56. Grappler PLUS Graphics Interface 80
57. Buffered Grappler 16K Buffer (Expand to 64K) 150
58. Kensington System Saver Fan and Surge Suppr. 69
59. Super Cooling Fan Fan and Surge Suppr. 29
60. Gamma Disk Controller Card 48
61. Gamma II SS Disk Drive for II, IIe, IIplus 125
62. Gamma IIC SS Disk Drive for IIC 125
63. Rana ELITE 2 DSSD Disk Drive 335
64. Rana ELITE 3 DSSD Disk Drive 420
65. ERAM 80 80 col; 64K RAM for IIe 115
66. Novation Apple Cat II 300 Baud Modem 200
67. Novation 212 300/1200 Baud Modem 390
68. Nov 49059112 Mod. & Soft. for Macintosh CALL
69. Hayes Micromodem IIe 300 Baud Modem 145
70. Hayes Smartmodem IIC 300 Baud Modem for IIC 240
71. Wico 501030 Analog Joystick 36
72. Amdek Monitors CALL
73. Zenith Monitors CALL

SPECIAL PURCHASE



HP-41C \$105

While Limited Quantities Last

86. HP-41CV \$168
87. HP-41CX 245
88. Optical Wand 95
89. Card Reader 145
90. Printer 283
91. Quad R.A.M. (for HP41C) 60
92. Ext. Memory Module 60
93. Ext. Function Module 60
94. Time Module 60
95. HP-IL Loop Module 95
96. Digital Cassette Drive 400
97. Printer/Plotter (HP-IL) 335
98. HP-2225B ThinkJet Printer 375
99. HP-9114A Disk Drive 600

SLIMLINE Shirt-pocket Styled Power Packed Programmable LCD PROBLEM SOLVERS

100. HP-11C Scientific 58
101. HP-15C Scientific 90
102. HP-12C Financial 90
103. HP-16C Programmer 90



HUGE SAVINGS ON DISKETTES

	Dysan!	maxell	3M	SONY	wabash	MEMOREX
3 1/2" SSDD	28.00	25.00	25.00	25.00	—	—
DSDD	37.00	37.00	37.00	37.00	—	—
5 1/4" SSDD	17.00	14.00	14.50	13.00	11.50	11.50
DSDD	21.00	18.00	18.00	16.00	12.50	14.00
SSDD96TPI	28.00	24.00	24.00	—	—	—
DSDD96TPI	37.00	29.00	29.00	—	—	—
5 1/4" DSDDHD (For IBM AT)	45.00	39.00	40.00	—	24.00	—
8" SSDD**	25.00	29.00	25.00	—	19.00	—
8" DSDD**	29.00	32.00	29.00	—	20.00	—

Call for Quantity pricing for 10 boxes or more.

CALL TOLL FREE 800-621-1269 EXCEPT Illinois, Alaska

3M DATA CARTRIDGES

140. DC100 \$ 14.00
141. DC300A 18.00
142. DC300XL 21.00
143. DC300XL/P 22.00
144. DC600A 23.50
145. DC1000 15.00

Call for Quantity pricing for 10 cartridges or more

ELEK-TEK, inc.

6557 N. Lincoln Ave., Chicago, IL 60664
 (312) 631 7800

Corp. Accts. Invited. Min. Ord. \$15.00. Visa or MasterCard by Mail or Phone. Mail Cashier's Check, Mon. Ord., Personal Check (2 wks. to clear) Add \$4.00 1st item. (AK, HI, PR, Canada add \$10.00 first item) \$1.00 ea. add'l shpg. & handl. Shipments to IL, address add 7% tax. Prices sub. to change. WRITE for free catalog. RETURN POLICY: Defective Only. Most products replace within 30 days of purchase with identical merchandise only. Computer and large peripherals replaced only when defective on arrival (within 3 work days of delivery). Other problems covered by mfr. warranty. ALL ELEKTEK MERCHANDISE IS BRAND NEW, FIRST QUALITY AND COMPLETE. Delivery subject to availability. DUNS #09-718-9517

Fully charged, the battery provides power for the //c and an LCD flat-panel display for up to seven hours. In practical use, five to six hours is more realistic. Extensive use of a disk drive and peripherals that depend on the computer for electric current (such as a modem) consumes power hungrily. Applications not requiring much disk access, such as word processing, yield better power "mileage."

The Cari battery also doubles as an ideal uninterruptible power supply (UPS) for everyday use. In UPS applications, the //c transformer cube furnishes a constant charging current for the Cari battery, which supplies juice to the //c. In a power failure, your supply is good for up to seven hours. More importantly, you won't lose data after a sudden power cut-off.

Get Up and Go

While the Cari makes a good tote for your gear, I wouldn't call it the world's most comfortable work set-up. You may not mind computing directly from the Cari, but I prefer a desktop or traditional work surface. The Cari obliges with an extension cord that lets you remove the computer and flat-panel display while the other components remain securely packed.

If you travel frequently with your computer, or if you're just looking for an uninterruptible power supply that doubles as a mobile computing unit, the Cari Portable Powered Work Station is worth your consideration. ■

Tom Benford
Bricktown, NJ

MW-100 C-Print Interface

Micro-W Distributing

1342B Route 23
Butler, NJ 07405

Printer interface
Apple //c
\$99.95

★★★★

Are you in the market for an economical parallel printer for your Apple //c? For your text-processing needs, you'll want to check out the MW-100 C-Print interface. There are no special hook-ups or configurations to worry about, since this compact unit plugs directly into the //c's printer port and emulates an Apple Imagewriter in text mode.

The MW-100 C-Print includes a 5-foot serial cable with a DIN connector that plugs into the //c. The interface module itself (a black plastic case containing the necessary support and translation circuitry) is connected to the other end of the serial cable. A flat-ribbon cable with a Centronics-type parallel connector extends from the opposite end of the module box. The ribbon cable and the module box increase

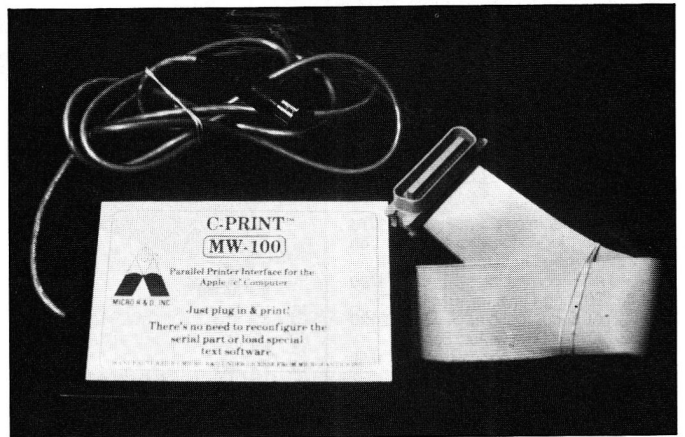

MW-100 C-Print, a serial-to-parallel interface for the //c.

the length of the unit to slightly less than 7 feet, a comfortable distance for most printer installations.

The interface gets its 5-volt power supply from pin 18 of the printer's 36-pin connector. If pin 18 doesn't carry this voltage, you can get a separate power supply from Micro-W for \$9.95. You can also use any of the popular video-game or calculator AC power adapters that have 3½-millimeter (⅛-inch) phone plugs and can provide 9 volts at 100 mA or better. I used a Star SG-15 printer for testing purposes. This supplied the necessary 5 volts at pin 18.

If you want to use a separate power supply, you must change the position of the power jumper inside the C-Print. To do this, remove the four screws that hold the module housing together, and move the jumper cap over to the J2 side of the three-pin contact. This minor modification is necessary only for Epson, BMC, and other printers that don't supply 5 volts at pin 18, or whenever you want to use an external power source.

The MW-100 C-Print uses the standard printer default (PR#1) and transmits data at 9600 baud with standard DTR handshaking, which eliminates data loss. The C-Print is intended primarily for text applications, however, and may not function properly (or at all) for certain graphics applications.

There are no optional settings or switches with which to contend, since the interface emulates Imagewriter's text mode. To use C-Print, plug one end into the //c and the other end into the printer.

The documentation lists a couple of short printer test programs that let you verify proper operation of the interface. The C-Print worked perfectly during testing with word-processing software and for listing BASIC programs. As expected, I encountered some problems when trying to access graphics features. (Micro-W plans to market an intelligent graphics interface, the C-Print+, which will emulate the Imagewriter's graphics capabilities.)

If you use your printer mainly for text processing, the C-Print is a well-designed, economical interface that should serve your purposes admirably. ■

Tom Benford
Bricktown, NJ

NEW PRODUCTS

edited by Paul Statt

Easy Modem

The **ProModem 300C** uses CMOS technology to drive an intelligent data communications device from the gameport of your //c. The microprocessor provides auto-redial on busy signals, a call-waiting bridge, and a choice between rotary and touch-tone dialing. The ProModem 300C package includes ProCom-A, a ProDOS communication program, but is also command-compatible with the Hayes Smartmodem 300 and most other communications software. The price is only \$199 from Prometheus Products, 4545 Cushing Parkway, Fremont, CA 94538, (415) 490-2370. For more information circle number 350 on the Reader Service card.

Survival School

Your plane took a dive into the Sierra Nevadas. You salvage some bread, a warm jacket, and a topographic map from the wreck. **Wilderness: A Survival Adventure**, is the story of your trek to the ranger station on a nearby peak for aid. You'll need to learn real navigation skill and survival techniques. The program and illustrated fieldbook borrow heavily from the USAF Survival School manual. Further survival adventures are planned. A color monitor is not necessary but it helps. Wilderness retails for \$50, from Electronic Arts, 2755 Campus Drive, San Mateo, CA 94403, (415) 571-7171. For more information circle number 362 on the Reader Service card.

Quick Pascal

Instant Pascal teaches you the basics of the language without the wait. Instant Pascal is an interpretive language—that means you see program operation at once, without waiting for your Apple to compile the code. Learning is easier when you interact immediately with your program; you won't miss the speed an interpreter sacrifices to a compiler, unless you're writing commercial software. Instant Pascal sells for \$140, but schools pay less for packages, from Apple Computer, 20525 Mariani Avenue, Cupertino, CA 95014, (408) 996-1010. For more information circle number 480 on the Reader Service card.

Bar and Code

SymbTrak prints and reads bar code with the Apple //e. The system includes a hand-held scanning wand, ROM-based software, a tutorial disk, and complete instructions on applying bar-code technology to your business. You can use either ProDOS or DOS 3.3. The symbol-printing software lets you mix text and bar codes when you use certain printers. The price for a standard SymbTrak unit starts at \$495, from Advanced Business Technology, 1180 Coleman Avenue, San Jose, CA 95110, (408) 275-9880. For more information circle number 369 on the Reader Service card.

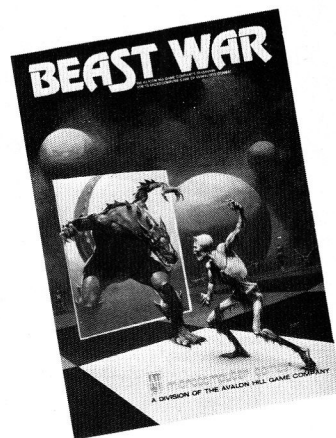

May the Best Beast Win

Beast War combines arcade combat and strategic skills in a single game. Constant conflict—and consuming bloodshed—among the warring tribes in the distant galaxy of Alaxis has led the leaders to develop a violent alternative to battle—the Beast War. You—George Steinbrenner long ago and far away—coach a team of semi-intelligent beasts who compete in proxy tournaments for control of Alaxis. Adventure and action for \$25, from Avalon Hill, 4517 Hartford Road, Baltimore, MD 21214, (301) 254-9200. For more information circle number 360 on the Reader Service card.

Product descriptions contained in this section are based on information supplied to us by the respective manufacturers. These announcements are provided solely as a service to our readers and do not constitute endorsement by inCider of any given product.

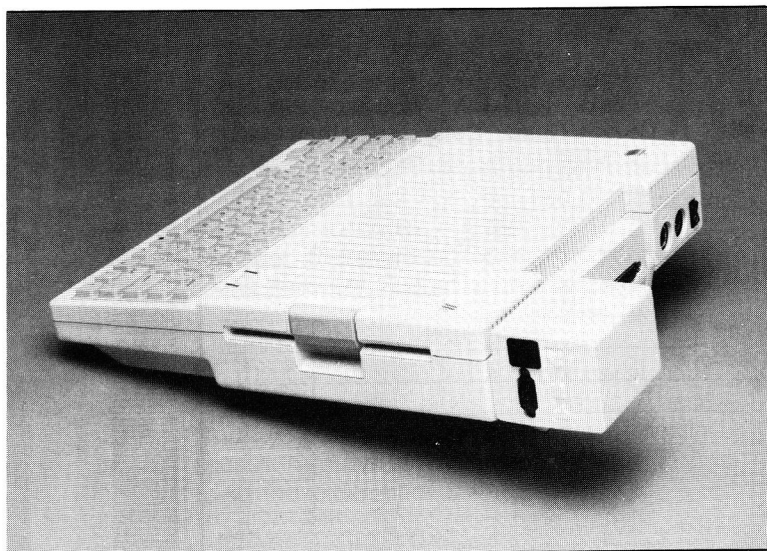

Connect a Prometheus Transportable Modem to your //c.

Subliminal Simulation

Silent Service, Gunship, and Aerojet are three exciting new simulations from MicroProse. Silent Service puts you at the bridge of a submarine in the Pacific in WWII. You'll pilot an AH-64 Apache attack helicopter in Gunship, while Aerojet seats you in the cockpit of a BDJ-5 sport jet. All three simulations sport superb graphics, intelligent, useful manuals, and always the thrill of the real thing. Each voyage costs \$34.95 from MicroProse, 120 Lakefront Drive, Hunt Valley, MD 21030, (301) 667-1151. For more information circle number 374 on the Reader Service card.

On Track

McBall lets you "drag" your mouse without jamming your finger down on a button. Besides its drag button, the low-cost track-ball has a click button that duplicates the mouse's other function. McBall uses less desk space than the everyday mouse. Its unique design gives the hand-capped easy Apple access, too. The McBall is available for \$89.95 from Interfirm Systems, 110 Pioneer Way, Building H, Mountain View, CA 94041, (415) 964-4464. For more information circle number 351 on the Reader Service card.



McBall is as handy as a mouse.

It's a Date

Time-Trax for the Apple //c makes good one of the little computer's few failings—lack of an internal clock. Time-Trax includes time-management software that streamlines your schedule. The clock plugs into the //c through its printer or modem port. The //c System Clock is ProDOS-compatible and works with AppleWorks or other ProDOS volumes for automatic time- and date-stamping of files. The Time-Trax sells for \$119.95, the //c System Clock for \$129.95 from Creative Peripherals Unlimited, 1606 South Clementine, Anaheim, CA 92802, (714) 535-1155. For more information circle number 375 on the Reader Service card.

Oceanic Utilities

The Cape Cod Convertible rewrites your BASIC code from its Applesoft origin into CP/M, MS-DOS, or PC-DOS. Conversions to True BASIC, TRS-DOS, and Mac BASIC are in the works. In addition to line-by-line conversion, The Cape Cod Convertible makes program analysis and debugging possible for programmers of limited experience. You can also accomplish mass conversions—a boon for developers. A one-way trip costs \$150, a round-trip ticket \$225, from Cape Cod Software, P.O. Box 654, Eastham, MA 02651, (617) 255-9537. For more information circle number 363 on the Reader Service card.

Local Mail

The **Bank Street Mailer** is a complete correspondence system that includes a mailing-list data base, a letter-writing program, and full mail-merge capability. It's compatible with the Bank Street Writer, Filer, and Speller. Envelopes and mailing labels are easy to print, and if you write only rarely, the built-in word processor will have all the power you need. An on-screen calculator is available too. Homes, schools, and small businesses will all want the Bank Street Mailer, for \$69.95, from Broderbund Software, 17 Paul Drive, San Rafael, CA 94903, (415) 479-1170. For more information circle number 368 on the Reader Service card.

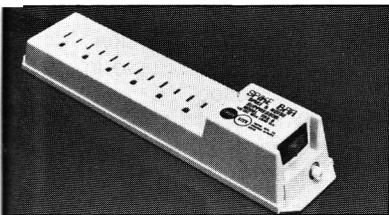

Spike Bar bars spikes—and surges.

Last Spike

The **Spike Bar** turns a single electrical source into a fully protective spike- and noise-protection device with six outlets. A 6-foot long power line, lighted on/off switch, test lamp, and a 15-amp circuit breaker complete the package. \$49.95 from TrippLite, 500 North Orleans, Chicago, IL 60610, (312) 329-1777. For more information circle number 364 on the Reader Service card.



LIFETIME LEARNING™ STARTS HERE

The gift of learning — start your child's Learning Library™ with affordable, quality software from Learning Technologies.

For Grades Pre K-3 select from:

Clowning Around, Flying Carpet, Learning to Add & Subtract, How to Weigh an Elephant, Let's Go Fishing.

Continue Your Library For Grades 4-8 With:

Scrambled Eggs, Alpine Tram Ride, Monkey Business, Sliding Block, Speedy Delivery.

TO ORDER OR FOR THE NAME OF THE DEALER NEAREST YOU CALL OR WRITE.

COST: \$19.95 each. Please add 10% of total purchase price to cover shipping/handling. Texas Residents please add 5.125% sales tax. Guaranteed delivery in time for Christmas.

ORDER INFO: Send Check, Money Order or Credit Card # (Visa/MasterCard). Credit Card orders call Toll Free 800-238-4277. Specify Name of Program(s) and computer. Available for Apple II family and Commodore 64 or 128.

SATISFACTION GUARANTEED: 100% Money Back including shipping if not completely satisfied.

Learning Technologies Dept. I

4255 LBJ Fwy., Suite 131,
Dallas, Texas 75244, 214-991-4958.

© 1985 Learning
Technologies, Inc.

Circle 93 on Reader Service Card.

The ADALAB™
Data Acquisition
System For
Laboratories

Costs
Less Than **\$2300***

- ADALAB™ data acquisition system interfaces with virtually any lab instrument using a recorder or meter, including GC and HPLC systems, spectrophotometers, pH meters, process control apparatus, thermocouples, etc. Thousands of scientists use IMI products worldwide!
- Lab Data Manager™ software (\$250) facilitates single or multi-channel acquisition, storage, display and chart recorder style output of lab instrument data.

*\$2290 price includes 64K APPLE IIe, disk drive with controller, 12" monitor; dot matrix printer with interface; IMI ADALAB™ interface card.

\$495 ADALAB™ INTERFACE CARD (available separately) includes 12-bit A/D, 12-bit D/A, 8 digital sense inputs, 8 digital control outputs, 32 bit real-time clock, two 16-bit timers plus QUICK I/O data acquisition software that works within easy-to-use BASIC.

Call, write or telex IMI for complete details!
†Trademark of Apple Computer, Inc.

ATTENTION APPLE OWNERS

IMI INTERACTIVE MICROWARE, INC.
P.O. Box 139, Dept. 52 Telex: 705250
State College, PA 16804 (814) 238-8294

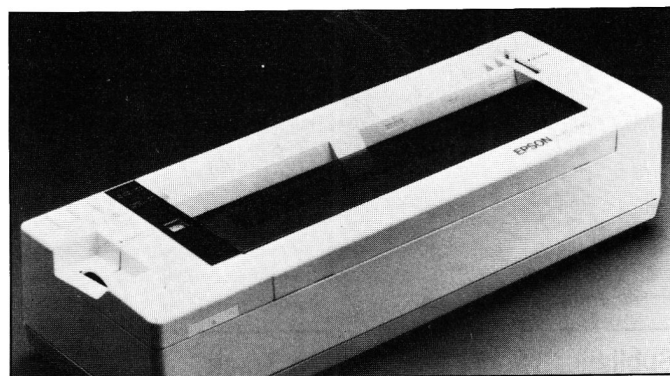

The Epson HS-80 LetterJet Printer for jet set computerists.

Jet Set

Epson manufactures a low-priced portable ink-jet printer, the **HS-80 LetterJet**. The LetterJet races at 160 characters per second in the draft mode and approaches letter quality at 32 unidirectional cps. Nonimpact ink-jet printing technology ensures crisp, professional-looking documents without the drone and vibration caused by impact dot-matrix printers. The tiny LetterJet measures 13.7 by 4.8 by 3.2 inches and uses built-in rechargeable nicad batteries for easy traveling. The four-pound HS-80 LetterJet comes with a one-year warranty for \$449 from Epson America Computer Products, 2780 Lomita Boulevard, Torrance, CA 90505, (213) 539-9140. For more information circle number 355 on the Reader Service card.

Quit Crabbing

The **Cramapple 512K** increases memory of the Apple II or II Plus from a meager 48K or 64K up to half a megabyte of available RAM. You can use the Cramapple as either a single large disk of memory or as three distinct banks equal to three 35-track floppy disks. You save a lot of time that would have been wasted going to the

disk in applications like searches and sorts. The Cramapple's price is \$349, which includes a 512K memory board and a DOS-based boot disk. From BFM Products, P.O. Box 942, Felton, CA 95018, (408) 263-9378. For more information circle number 367 on the Reader Service card.

Apple Talking

Let's Talk operates your Apple while you're away and serves as a sophisticated answering machine and information center. You can set up a micro version of Dialog or CompuServe in your office, school, or home. What goes on-line is up to you. Let's Talk provides electronic mail—your correspondents can thumb through your catalogs or place an order. They can send files to you or receive messages with simple key commands. The password option keeps your mail a secret. Let's Talk sells for \$125 from Russ Systems, 320 Dufour, Santa Cruz, CA 95060, (408) 427-1540. If you have a modem, your IIe or IIc can bring you a free demonstration at (408) 427-0310. For more information circle number 365 on the Reader Service card.

30%
SAVINGS
off cover price

30%
SAVINGS

inCider

Send me 12 issues of **inCider** for \$24.97. I save 30% off the cover price.

24 issues for \$38.00. Save 46% off the cover price.

Payment enclosed Bill me
Please make checks payable to **inCider**.

Name _____

Address _____

City _____ State _____ Zip _____

Canada & Mexico \$27.97, 1 year only, US funds drawn on US banks.
Foreign Surface \$44.97, 1 year only, US funds drawn on US banks.
Foreign Airmail, please inquire. Please allow 6-8 weeks for delivery.

35AB5F

A one year subscription (12 monthly issues) at the low, rate of \$24.97! Save over \$10.00 off the newsstand rate.

Apple is a registered trademark of Apple Computer, Inc.

YES! I want a one year subscription (12 issues) for only **\$24.97.**

inCider—The Apple Journal— the best in software and hardware reviews, entertainment, education and answers to your most pressing questions.

30%
SAVINGS

inCider

Send me 12 issues of **inCider** for \$24.97. I save 30% off the cover price.

24 issues for \$38.00. Save 46% off the cover price.

Payment enclosed Bill me
Please make checks payable to **inCider**.

Name _____

Address _____

City _____ State _____ Zip _____

Canada & Mexico \$27.97, 1 year only, US funds drawn on US banks.
Foreign Surface \$44.97, 1 year only, US funds drawn on US banks.
Foreign Airmail, please inquire. Please allow 6-8 weeks for delivery.

35AB5F



YES! I want a one year subscription (12 issues) for only **\$24.97.**

UNCONDITIONAL GUARANTEE

If **inCider** doesn't prove to be everything we say it is, just tell us. We'll refund your money for all undelivered issues—no questions.

Add to your computing skills with monthly features like:

- Off-the-shelf solutions to your computing needs.
- Reader interaction for more user-friendly information.
- An ongoing course on Applesoft Basic language.
- Special articles to increase your personal productivity.
- Ready to run program listings.

30%
SAVINGS

inCider

Send me 12 issues of **inCider** for \$24.97. I save 30% off the cover price.

24 issues for \$38.00. Save 46% off the cover price.

Payment enclosed Bill me
Please make checks payable to **inCider**.

Name _____

Address _____

City _____ State _____ Zip _____

Canada & Mexico \$27.97, 1 year only, US funds drawn on US banks.
Foreign Surface \$44.97, 1 year only, US funds drawn on US banks.
Foreign Airmail, please inquire. Please allow 6-8 weeks for delivery. **35AB5F**

YES! I want a one year subscription (12 issues) for only **\$24.97.**



BUSINESS REPLY MAIL

First Class Permit No. 73 Peterborough, NH 03458

POSTAGE WILL BE PAID BY ADDRESSEE

CW Communications/Peterborough
inCider
PO Box 911
Farmingdale, NY 11737

NO POSTAGE
NECESSARY
IF MAILED
IN THE
UNITED STATES

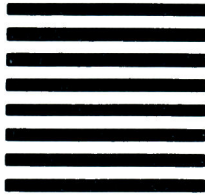

BUSINESS REPLY MAIL

First Class Permit No. 73 Peterborough, NH 03458

POSTAGE WILL BE PAID BY ADDRESSEE

CW Communications/Peterborough
inCider
PO Box 911
Farmingdale, NY 11737

NO POSTAGE
NECESSARY
IF MAILED
IN THE
UNITED STATES

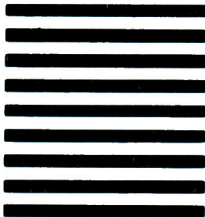

BUSINESS REPLY MAIL

First Class Permit No. 73 Peterborough, NH 03458

POSTAGE WILL BE PAID BY ADDRESSEE

CW Communications/Peterborough
inCider
PO Box 911
Farmingdale, NY 11737

NO POSTAGE
NECESSARY
IF MAILED
IN THE
UNITED STATES

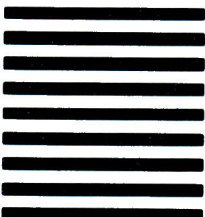

30%
SAVINGS
off cover price

**A one year subscrip-
tion (12 monthly is-
sues) at the low, rate
of \$24.97! Save over
\$10.00 off the news-
stand rate.**

inCider—The Apple Journal—
the best in software and hardware
reviews, entertainment, education
and answers to your most pressing
questions.



UNCONDITIONAL GUARANTEE

If inCider doesn't prove to be
everything we say it is, just tell us.
We'll refund your money for all unde-
livered issues — no questions.

Add to your computing skills with monthly features like:

- Off-the-shelf solutions to your computing needs.
- Reader interaction for more user-friendly information.
- An ongoing course on Applesoft Basic language.
- Special articles to increase your personal productivity.
- Ready to run program listings.

Call Me

The **JC-1200A Smart Modemphone** is Hayes-compatible, has auto dial, auto answer, and automatic baud rate selection. What's special is the built-in voice telephone. A tone-sensing circuit can tell carrier from voice transmission and sends the signal to either the phone or the computer. A clock/calendar feature keeps track of the call length on your monitor. Auto redial on busy and a self test are standard. The Smart Modemphone needs a standard RS-232 port and is priced at \$289.95, from Thrall Engineering, P.O. Box 167, Oxford, PA 19363, (215) 932-3488. For more information circle number 366 on the Reader Service card.

Printer Perfect

The Epson **FX-85** and **FX-185** dot-matrix printers offer a choice to business-people who want print-speed for drafts as well as quality for letters. The new printers create 9 by 9 dot-matrix characters, feature logic-seeking bidirectional printing, and make 96 ASCII and 11 international character sets. Horizontal

The Epson FX-85 and FX-185 print well and fast.

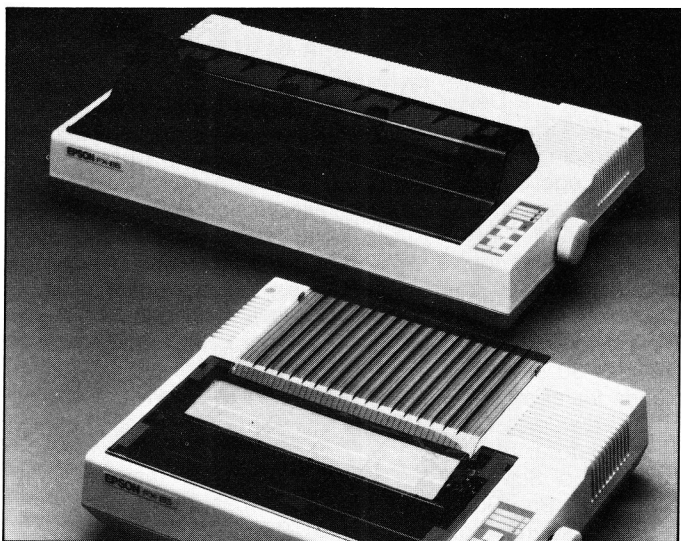

inCider

and vertical tabulation are standard. All kinds of characters are possible, as are accurate graphics. The FX-85 sells for \$499, the 136-column FX-185 for \$699 from Epson America Computer Products, 2780 Lomita Boulevard, Torrance, CA 90505, (213) 539-9140. For more information circle number 353 on the Reader Service card.

Letter Perfect

Epson FX printers can produce near letter-quality work with **LetterWriter**. The NLQ mode offers four times the resolution of standard printing for finer character printing and no visible dots. You enter the enhanced mode simply by tapping the printer panel buttons. In Apple mode the FX printer will accept graphics and control codes for //c software like Mouse-Point. The LetterWriter replacement ROMs for FX-80 and FX-100 printers sell for \$79.95 from Dresselhaus Computer Products, 837 East Alosta Avenue, Glendora, CA 91740, (818) 914-5831. For more information circle number 352 on the Reader Service card.

kyan

PASCAL For the Apple

kyan pascal is the most complete package available for learning and using the Pascal language. And now, it's available for the Apple II family of computers.

kyan pascal is easy to use, lightning fast, and loaded with features. It's a full Pascal implementation. It compiles and runs many times faster than other Pascal compilers.

kyan pascal features:

- Optimized Machine Code Compiler;
- Built-In Full Screen Text Editor;
- String-Handling, Chaining, Include File, and Other Powerful Extensions;
- Random Access Files and Full Graphics Support;
- Built-In Assembler (Allows Full Hardware Control);
- 13-Digit Arithmetic Precision; and,
- Tutorial Manual with Sample Programs.

kyan pascal requires 64K of memory and a single disk drive. No additional hardware is necessary. And, it comes with kyan's **MONEY BACK GUARANTEE**... **If not completely satisfied, return it within 15 days for a full refund.**

kyan pascal for the Apple **\$69.95**
(Add \$4.50/copy for handling, \$12.00 outside North America, California residents add \$4.55/copy for sales tax)

Send Check/Money Order to: **kyan software**, Dept. H
 Call: (415) 775-2923 1850 Union St., Ste. 183
 MC/Visa Accepted San Francisco, CA 94123

Circle 91 on Reader Service Card.

IT'S LIKE FREE DISKETTES

Your 5 1/4" single side disks are usable on the other side. You paid for one side, why not use the other... **IT'S FREE!**

Nibble Notch will **open** your **new** disk. It's easy... won't harm existing data. Try it!

nibble notch I

For Apple, Franklin, Commodore & Atari (w/Atari Drives); square notch.

only **\$14.95*** PLUS P&H

nibble notch II

For all other computers; square notch & index hole.

only **\$21.90*** PLUS P&H

DISK OPTIMIZER II ©
 Apple II Series Software
Pro DOS • DOS 3.3 • Pascal
 Examines your **new** disk, locks out bad sectors and **certifies it 100% ERROR-FREE** in 30 seconds or less! Also checks drive speed...and more!

SUPER SAVER PACKAGE
 Nibble Notch I and Disk Optimizer Combo (Optimizer alone reg. \$24.95)
\$29.95* FOR BOTH!

QUALITY DISKETTES
low as **99¢**

*add \$2 (\$5 frgn) for P & H. Fl. Res. add 5% Sales Tax

Toll Free 1-800-642-2536

nibble notch computer products FL 1-305-748-3770 OR SEND CHECK OR MONEY ORDER TO:

4211 NW 75th TERRACE, • DEPT. 2 1 4 LAUDERHILL, FL 33319

Circle 100 on Reader Service Card.

NEW PRODUCTS

PROFESSIONAL HANDICAPPING SYSTEMS

• PRESENTED BY PROFESSOR JONES •

GLD. Thoroughbred "Gold" Edition™

A "Full" featured thoroughbred analysis designed for the professional and the serious novice. **\$159.95** complete

EGLD. Enhanced "Gold" Edition™

"Gold" Edition with complete Master Bettor™ system integrated onto the same disk. This powerful program will transfer all horses and scores to the bet analysis with a "single keystroke." (Master Bettor™ included) **\$199.95** complete

GLTD. Limited "Gold"™

Enables Professional Handicappers to assign specific values to the racing variables "they" feel are important. Create program weight based on a particular track and line tune it for maximum win percentage. This program is designed for "ease of use". The user needs **no programming experience.** (contains Integrated Bettor™) **\$299.95** complete

GD. Gold Dog Analysis™

The "ONLY" professional greyhound analysis available that evaluates ALL variables. **\$149.95** w/integrated Bettor **\$199.95**
Limited Version **\$299.95**

MHH. Master Harness Handicapper™

Professional software designed to provide a thorough analysis of all trotter and pacer races in North America and Canada. **\$159.95** complete
\$199.95 w/integrated Bettor Limited **\$299.95**

Professor Pix Football™

Complete STATISTICAL ANALYSIS on Data Base allowing "Designated" previous games to be evaluated. Statistical Series **\$99.95**
w/Win-Loss Power Ratings **\$149.95**

NBA. Basketball™

NBA **\$99.95** w/college **\$129.95**
w/power ratings **\$149.95**

LOT. Lottery Analysis™

Statistical comparison program designed to detect subtle patterns in winning numbers and digits. Lottery (3-4 digit) **\$79.95**
w/Lotto (Max. 99 Digit) **\$99.95**

PC-3 Portable Computer (4k) with choice of Thoroughbred, Greyhound or Trotter™ **\$249.95** (Includes portable computer and program.)

M-100 Portable (24k) w/choice of Thoroughbred, Greyhound, or Trotter. **\$649.95** (Includes portable computer and program.)

BROCHURE AVAILABLE

Circle 49 on Reader Service Card.

IBM™
APPLE™
TRS-80™
CPM™
COMMODORE™

Prof. Jones

1940 W. State St.
Boise, ID 83702



48 HR. FREE SHIPPING



CALL

208-342-6939

TERMS: FREE SHIPPING ALL SOFTWARE. Add \$6.00 hardware / \$6.00 C.O.D. / UPS Blue \$6.00 / Out of Country \$9.00 / ID Residents 4% / 3 weeks personal checks / Cash price only, add 2% Visa, MC / Prices subject to change.



Apple Radio

The **Computer Patch Model CP-100 Interface** is a complete terminal unit for Morse, Baudot, ASCII, and AMTOR. It will connect a computer running communications software to your radio. With its optional current loop provisions, the CP-100 can be used with a mechanical teleprinter. The front-panel squelch control keeps data from the computer when no signal is being received—no noise is printed. You can select 300 baud or 110 and below rates. The CP-100's attractive metal case minimizes RF interference. The Computer Patch Model CP-100 sells for \$369.95 from Advanced Electronic Applications, P.O. Box 2160, Lynnwood, WA 98036, (206) 775-7373. For more information circle number 357 on the Reader Service card.

The Computer Patch connects hams and Apples.

Font and Center

MouseFont adds 12 94-character typesets to the five that came with MousePaint. MouseFont's Font and Icon Editor lets you design and install custom typefaces, if you don't find your favorite among "Midget," the world's smallest typeface, "Down," for sideways labelling, "Icons," for pictures, and more. Eighty fancy fonts dress up graphics. All MouseFont fonts are accessible from MousePaint's fonts menu. MouseFont retails for \$34.95 from Ahware, 805 Luz Court, Danville, CA 94526, (415) 837-7346. For more information circle number 375 on the Reader Service card.

Product Updates

—Mouse Systems has dropped the price of the A+ Mouse from \$150 to \$99.

—You can now play The Learning Company's popular preschool game, Reader Rabbit, on Koala's Muppet Learning Keys.

—Mockingboard users can take advantage of a new Speech Development System (\$39.95), Foreign Language Rule Tables (\$24.95), and a Developer's Toolkit (\$29.95).

—Terrapin offers Enhanced Logo 3.0, a version of its language that runs on both 64K and 128K machines. Updates for versions 1.3 and 2.0 are available.

—FingerPrint Plus (\$149) provides 30 new commands for existing FingerPrint hardware.

—Five-dollar rebates go to buyers of Screenplay and Brown Bag Software, such as Asylum, Profes-

sional Blackjack, Caesar's Guide to Gaming, Trivia Arcade, and The Brown Bag Integrated Word Processor and Database.

—Broderbund responds to heavy demand with the Print Shop Graphics Library, Disk Two—200 images and pictures for \$24.95.

—Newsroom newspeople will be clipping from Springboard's Clip Art Collection, Volume I (\$29.95).

—Like your 10-megabyte Sider? Move up to First Class Peripherals' 20-megabyte version and receive a \$50 rebate. Refer a friend who buys a Sider to First Class and earn another 50 bucks.

—Road Race officials and organizers will save now that DB Software has reduced the price of the Road Race System from \$600 to \$195. Team/Relay Results has fallen in price to \$95.

SINK YOUR TEETH INTO THIS, APPLE



Langenscheidt Introduces Foreign Language and Travel Software With Substance

Langenscheidt Languageware: 4 vocabulary games with the most extensive foreign language word lists available in software. Personalized word lists easily entered in minutes. Vocabulary notebook included. Progressive levels of difficulty. Self-instruction or teacher assisted. In Spanish, French, German, or Latin. \$39.95 each.

Baedeker's Travelware: 4 programs that teach cultures, customs of France, Germany, Mexico, Japan. 30 situations per country challenge user to choose correct behavior. Amusing, engrossing, with graphics, sound effects, folk music. In English and target language. \$49.95 each (2diskettes per country).

	Title	Spanish	French	German	Latin	English
Langenscheidt Languageware	Vocabulary On The Attack	•	•	•	•	•
	Conclusion	•	•	•	•	•
	Rebound	•	•	•	•	•
	On Target	•	•	•	•	•
Baedeker's Travelware	Correct Behavior France	•	•	•	•	•
	Correct Behavior Germany	•	•	•	•	•
	Correct Behavior Mexico	•	•	•	•	•
	Correct Behavior Japan	•	•	•	•	•

Available for: Apple II, II+, IIe, IIc (DOS 3.3, 48K, one disk drive)

Please send me the items indicated below.

IC1085

Qty.	Title	Language	Amt.

Name _____

Address _____

City/State/Zip _____

C.O.D. M.C. Visa Amex

Number _____ Expires _____

Signature _____

Add \$2.00 each for shipping/handling

NY State Residents add Tax

TOTAL _____

Langenscheidt Publishers, Inc.

46-35 54th Road, Maspeth, New York 11378 (718) 784-0055

Circle 53 on Reader Service Card.

APPLE // DEALERS YOU'VE WAITED LONG ENOUGH

...for a half-height Apple® compatible disk drive that fits any Apple // you sell: //+, //e, and //c.



- Faster, more precise tracking and larger capacity than standard Apple® drives.
- 100% Apple® compatible for //+, //e, and //c external drives.
- Quieter and smoother running.

- Half-height, compact design... saves you space.
- //c adaptor plug included free!
- Works with Apple's new Unidrive
- One year warranty, 30 day money back guarantee.
- Suggested retail price: \$269.95

//c AND UNIDRIVE POWER

New! Apple //c Disk Drive Adaptor Plug. Also Works With Apple's New Unidrive.

- Turns your Apple //+ or //e compatible disk drive into an Apple //c drive.
- Allows you to use your Apple compatible disk drive with Apple's new Unidrive
- Attaches in seconds—absolutely no soldering!
- 5-year warranty, 30-day money-back guarantee.

**FAST•SIMPLE•INEXPENSIVE
ONLY \$19.95**

PICO products

Quality peripherals for IBM®, Apple®, and other leading microcomputers. Watch for more PICO Products at your local computer store—exceptional value and quality in computer accessories.

For Dealer and Distributor information please call or write:



WGE International Ltd.
WGE Center, Rte. 202N
Peterborough, NH 03458
1 (800) 227-1560
1 (603) 924-9261 in NH

IBM is a registered trademark of International Business Machines, Inc. Apple is a registered trademark of Apple Computer.

CLASSIFIEDS

Publications

DISKS FOR APPLEWORKS

NOTES FOR APPLEWORKS is no longer in print, but all the useful information has been included in a SYBEX paperback. Ask your Apple dealer or bookstore to stock APPLEWORKS TIPS & TRICKS, or order directly from SYBEX at (800) 227-2346. A template disk designed for use with the book is available for \$12 postpaid from:

ROBERT ERICSON, AICP
PO Box 16064
Rumford, RI 02916

MICROCOMPUTER BOOKS

Computer books for the mail order market: Inside the Apple II (\$17.95), Applesoft Basic Subroutines & Secrets (\$15.95), Data Base Management for the Apple (\$13.95), Apples for Teachers—101 Programs for the Classroom (\$12.95). MC/Visa. Current DIRECTORY (\$1.00).

MICRO BOOKS

PO Box 60203
Grand Junction, CO 81506
(800) 874-5280 Ext. 115 (US)
(800) 874-3426 Ext. 115 (CO)

Software

RECIPE MANAGEMENT

NONNIE'S FILE BOX by Ms. Nom de Plume. Your recipes entered using your word processor, recipes cross indexed, serving size adjusted, menus planned, grocery lists compiled, PLUS Nonnie's collection of tested recipes. For IIe, IIc, II+ w/lowercase. Free info or send \$39.95 to

PLUME SOFTWARE INC.
Box 2209
Altoona, PA 16603

PASS™

Personal Accounting Storage System. Record your personal accounting, keep history of your expenses a full year by category. Keep track of up to 9 books, print checks, keep a record of your ASSETS. Powerful set of file maintenance and report programs, i.e., NET WORTH, BUDGET ANALYSIS. Unlimited number of systems. Data is stored in standard text files. For Apple II+ w/64K, IIe, or IIc. \$48.50 + \$3.00 P&H. OH res add sales tax. MC, VISA, CHECK or MO.

BRINGARDNER DATA PRODUCTS
PO Box 24163
Columbus, OH 43224
(800) 628-2828 Ext. PASS

SPEEDUP HOME ACCOUNTANT

This package speeds up Home Accountant file processing 4 to 60 times, searches up to 100 times faster, speeds up garbage collection 9 times. It also allows you to switch checkbooks/types with only one keystroke, prompts you when entering split transactions, records auto. transactions multiple times during the month, PLUS MORE. DOS 3.3 Home Accountant only. VISA/MC accepted. MONEYBACK QUARANTEEED if not satisfied. Only \$19.00 + \$2.50 shipping/handling.

SOFTWARE SOLUTIONS

5516 Merritt Circle
Edina, MN 55436
For orders only:
1-800-835-2246 Ext 131

SOFTWARE FOR PENNIES

1000's of freely copyable programs for the Apple II/III/C: 220 disks categorized by subject and fully described in newly released 150 pg. book: "The Best of Apple Public Domain Software"—\$6.95 + \$1.50 post. 5 INTRO. DISKS + BOOK (bus., home mgmt., educ., utilities, games)—\$34. 3 BUSINESS DISKS (payroll, chckbk, gen. ledg.)—\$19. 5 EDUCATION DISKS (read, spell, math)—\$29. 5 UTILITY DISKS (disk ck, mem. dump, text file edit, file recovery)—\$29. Prepay ck, VISA, M/C.

THE PUBLIC
DOMAIN EXCHANGE
673 Hermitage Place, Ste. 6A
San Jose, CA 95134
(408) 942-0309

I CAN DO FOOTNOTES!!!

Harness the power of AppleWriter's footnote feature with FOOTwriter. Makes papers look almost typeset. WPL program includes: (a) 3 auto footnote formats, (b) auto FN numbering, (c) popular printer glossaries, (d) help screens, (e) ProDOS calendar pre-boot. \$19.50 + \$1.00 postage. Specify DOS 3.3 or ProDOS.

RKB SOFTWARE
1149 South 1100 East
Salt Lake City, UT 84105
(801) 583-4383

OUTLINER DEL CONDE

Develop outlines, \$39.95: intro price, quantity discounts. Enter ideas as they pop into your mind, then organize them quickly. Ideas can be gathered, split, moved, copied, erased, inserted, appended, and raised/lowered in importance; text processing too. For II+, e, c. - U/L case on e/c. 48K, 1 drive. Orders & inquiries to:

DEL CONDE VENTURES
41 Forrest Road
Randolph, NJ 07869

SOFTWARE GALORE!

Four Big Reasons to buy from Soft Source-R

1. Top selling Apple/IBM programs
2. Up to 40% off
3. Recreational, educational, sm. business
4. FREE shipping!

FREE brochure. Specify computer.

THE SOFTSOURCE-R INC.
Dept. B Box 2931
Joliet, IL 60434

FOR IMAGEWRITER-APPLE DMP

Bold, condensed, enlarged, proportional, slashed zeros, or unidirectional at the touch of a key. Combine them too. Very fast and easy. Menu-driven software with manual. Any Apple II. WRITE-STYLE. \$20 PPd.

GREEN MOUNTAIN SOFTWARE,
DEPT IC
PO Box 40853
Portland, OR 97240

Games

WIZARDRY IV AND BEYOND

Why wait for Sir-Tech? Conquer the WIZI-gods today! Create your very own death-dealing dungeon w/healing pools, elevators, chutes, pits, etc. Stock it with your own pet-monsters, tantalizing treasure chests, & magical armor & weapons. The first COMPLETE scenario editor ever offered to the public. Why settle for just hint sheets/books? All three scenarios! Introductory offer: only \$34.99!! (Send check or M.O. now)

MAGICSOFT
529 Farragut Place, Dept. A1
Danville, CA 94526
(415) 820-0711

ATARISOFT FOR APPLE \$6 EACH

Pac-Man
Defender
Dig Dug
Donkey Kong
Robotron
Stargate
Centipede
BUY 5, GET ONE FREE
Add \$2.00 shipping and handling on orders under \$50.00.



ABBY'S SOFTWARE
37 South Broad St.
Fairborn, OH 45324
phone: (800) 282-0333 to order
VISA/MC

\$2.65 ADVENTURE HINT

BOOKS. Clues, solutions, maps, trivia: Ultima III, Deadline, Witness, Starcross, Zork I, Zork II, Zork III, Planetfall, Adventure, Wizard & Princess, Drk Crystl, Transylvania, Quest, Expedition Amazon, Coveted Mirror, Mystery House, Mask Sun, Serpents Star, Death Caribbean, Ulysses. Map Sets: Wizardry, Knight Diamonds, Legacy Llylgamyn, Shadowkeep.

ASPEN SOFTWARE
1357 Diamond Drive
Prescott, AZ 86301

Utilities

USE APPLE II BASIC PROGRAMS?

If so, then you owe yourself a look at DataChief™. This powerful, easy-to-use, data saving and loading software can save you time and frustration. Complete DataChief package \$18
Demo Disk and Manual \$9
Manual alone \$4

DATACHIEF
5408 Simmons Dr.
Lumberton, NC 28358
(919) 738-7834

Hardware

LOWEST PRICES ON APPLE COMPATIBLES!!!

Extended 80-Col w/64K RAM Apple IIe \$59.95
Disk Controller II+, IIe for 2 drives \$37.95

Z-80 CP/M Card II+, IIe run bus. prog. \$44.95
16K RAM Card w/cable exp. II+ to 64K \$37.95
Cooling Fan w/outlet, switch RR, II+, IIe \$32.95
EPROM Card prog 2716/32/64 II, II+, IIe \$64.95
Disk Notcher w/guide cuts square holes \$9.95
Send MO/Check + \$2 per item
S&H. NY res. add local tax.

MICRO ACCESSORIES
PO Box 4512D
Bay Terrace, NY 11360
(718) 428-4943 9-6 pm

MOUSETRACER

Use your Mac, IIe, or IIc mouse and draw like the pros! Put cartoons, pictures, maps, etc. on the drawing board. Strap your mouse to the Mousetracer and with your favorite graphics program trace the picture of your choice. Works like a 1:1 drafting board pantograph. Send \$34.95 + \$3 UPS shipping (CA res add \$2.10 sales tax) to:

BRIMARK INNOVATIONS
9821 Yolanda Ave.
Northridge, CA 91324

LOOK at these GREAT PRICES

Now in Stock!!!
 The affordable, Half-height Apple compatible disk drive from PICO Products.
 List \$265.95 **NOW only \$189.95***
 One Year Warranty

\$9.97 Specials	Best Sellers	List	OUR PRICE
Planetfall	Karateka	34.95	22.95
Word Scrambler	Routine Machine	29.95	14.95
Stellar 7	The Last Gladiator	35.00	14.95
Know Your Apple	Fahrenheit 451	39.95	26.95
Caverns of Callisto	Amazon	39.95	26.95
Skybombers II	Shadow Keep	39.95	26.95
Apple Clinic	Summer Games II	39.95	26.95
Capitalization	Hard Hat Mac	39.95	19.95
Santa Paravia	Flight Simulator II	49.95	37.95
Voodoo Castle	Sargon III	49.95	31.95
Ghost Town			
Oil Tycoon			

Flip n File II List \$29.95
 Holds 50 Now \$19.95*
 Disks With Lock

Similar SAVINGS on Hundreds of Products.

Dollar Disks!
 Lifetime Warranty
 Nationally known brand!!
 SS/DD only \$1.00 each
 DS/DD only \$1.15 each

STOCK UP NOW

instant Software

computer centers

KEENE • **NASHUA** • **HUDSON** • **BOSTON** • **WELLESLEY** • **ACTON**
 82 Main St. Nashua Mall 358 Lowell Rd. 355 Boylston St. 1709 Worcester Ave. 427 Great Rd.
 803-352-3736 803-889-0084 803-863-8000 617-353-1582 617-235-8852 817-263-0418

Name _____
 Address _____
 City _____
 State _____ Zip _____

Mail to:
 Instant Software
 82 Main Street
 Keene, N.H.
 03431

To Order Call NOW—TOLL FREE 800-843-6700 Ask for operator 1107—in N.H. call 352-3763
 Terms: Visa, Mastercard, MO, Check. Add \$3.00 for shipping/handling. U.S. funds only. *Plus shipping. Some items are limited in quantity.

עכשו בעברית

Now available from
DAVKA

The World Leader in Hebrew Software

for the II+, IIe, and IIc

Appleworks-The best-selling word processor, database, and spreadsheet program...now in Hebrew/English

Quickfile-Apple's great database program...now in Hebrew/English

Hebrew Screenwriter II-Sierra's powerful word processor...now in Hebrew/English

Ulpan Davka-An integrated series of Hebrew Language programs for every age level

for the Macintosh

Mousewrite-A full-featured Hebrew/English word processor with Macwrite features

Notzah-An outstanding Hebrew/English database, spreadsheet, and integrated software package. Meshes with Mousewrite for mail-merge and other applications.

For information on these and other programs on Hebrew and Judaic subjects, write or call:

Davka Corporation 845 N. Michigan Ave.
 Suite 843 Chicago, IL 60611
 (312) 944-4070

Apple, Appleworks, and Quickfile are trademarks of Apple Computer Corp.

Education

SUPER SOFTWARE SAVINGS

FREE catalog of Software and Hardware at FANTASTIC SAVINGS! Specializing in Apple and IBM educational software is our specialty! We accept school purchase orders. The Newsroom—\$35.95. . . Easy Graph—\$29.95. . . Bank Street Writer (for schools)—\$87.95.

SMALL BUSINESS COMPUTER CONSULTANTS
 P.O. Box 1191
 Thousand Oaks, CA 91360
 (805) 492-9391

Graphics

EXPAND YOUR GRAPHICS. . .TEN TIMES

CHARTS UNLIMITED is a graphics/text processing program that gives the Apple II incredible graphics capability. Now you can produce high quality, full page flowcharts, organization charts, floorplans, circuit diagrams, schedules and many more types of charts. This \$195.00 program gives you extremely fast graphics plus a drawing area that is equal to 10 Hi-Res graphics screens. For more information or a FREE brochure call or write to:

GRAPHWARE INC.
 PO Box 373
 Middletown, OH 45042
 (513) 424-6733

User Groups

FRANKLIN USERS GROUP

Supporting users of II, II+, FRANKLINS, and ALL COMPATIBLES. We provide a monthly newsletter, public domain library and personal attention.

Membership \$20.00 a year. We offer discount hardware & software. Checkmate Multiview 80/160 only \$299 80 to 160 column display. Runs AppleWorks on 64K clones & II+'s!

FUG
 67 E. Wind
 Tecumseh, MO 65760

New Rates Effective September 1, 1985

\$150.00 per issue (minimum of three issues)

\$125.00 per issue (minimum of six issues)

For further information, call or write:

Kim Labbe
 inCider Classifieds
 80 Pine St.
 Peterborough, NH 03458

BEGINNER'S PAGE

The purpose of this page is to help beginners type in and enjoy the programs *inCider* publishes. You must have an Apple II, II Plus, IIe, or IIc with one disk drive and either DOS 3.3 or ProDOS, and a blank, 5¼-inch disk.

CREATING A BASIC PROGRAMS DISK

Before you begin, you must prepare a disk on which to save your programs. This process is called *formatting*. Follow the specific instructions below for your computer-operating system combination. In addition, ProDOS requires you to copy two files to create a start-up disk.

ProDOS, version 1.0.2—Apple IIc

- 1) Put your System Utilities disk into the internal drive, and turn on your computer.
- 2) When the main System Utilities menu appears, type 6 and hit the return key.
- 3) At each of the next two menus, type 1 and hit the return key.
- 4) Accept the default volume name by pressing the return key.
- 5) Remove the System Utilities disk and insert the blank, unformatted disk. Then press the return key.
- 6) When the message "Formatting... Done!" appears, hit the escape key.

Now copy PRODOS and BASIC.SYSTEM onto your formatted disk.

- 7) Type 1 and hit the return key. (Do this three times.)
- 8) Remove your programs disk and insert the System Utilities disk. Then type S and hit the return key.
- 9) Press the down-arrow key until PRODOS is highlighted. Then hit the right-arrow key.
- 10) Hit the down-arrow key until the brackets surround the words BASIC.SYSTEM. Hit the right-arrow key, then the return key.
- 11) When prompted, remove the System Utilities disk (the source disk) and insert your programs disk (the destination disk). Then hit the return key.
- 12) Switch disks twice more when prompted, and press the return key each time. The message "Copying PRODOS... Done!" will appear, followed by "Copying BASIC.SYSTEM..."
- 13) Switch disks twice more when prompted, and press the return key each time.
- 14) When copying is done, label the disk "*inCider* programs disk #1."

Note: You can avoid disk swapping if you have an external drive. See page 20 of the *System Utilities Manual* for that method.

ProDOS, version 1.0.1—Apple IIe or II Plus with 64K RAM

- 1) Insert the ProDOS User's Disk into drive 1 and turn on your computer.
- 2) At the first menu, hit the F key. At each of the next two menus tap the V and F keys, respectively. Press the return key twice.
- 3) Remove the User's Disk, insert a blank, unformatted disk, and hit the return key.
- 4) When formatting is complete, hit the escape key twice.

You now have to copy PRODOS and BASIC.SYSTEM onto your formatted disk.

- 5) At the Filer menu, hit the F key, then the C key.
- 6) Type PRODOS; then type /BLANK00/PRODOS, hitting the return key each time.
- 7) Remove your formatted programs disk (the destination disk), insert the User's Disk (the source disk), and hit the return key.
- 8) At the prompt, switch disks and hit the return key.

Note: On a two-drive system, drive 2 spins before the prompt appears. To use drives in the copying process, see page 80 of the *ProDOS User's Manual*.

- 9) When "Copy Complete" appears, type BASIC.SYSTEM and /BLANK00/BASIC.SYSTEM, hitting the return key after each.
- 10) Switch disks twice more, and hit the return key each time.
- 11) When copying is complete, label the disk "*inCider* programs disk #1."

DOS 3.3—Apple II Series

- 1) Insert the System Master disk into drive 1 and turn on your computer.
- 2) At the Applesoft prompt], type NEW, then 10 HOME; hit the return key after each.
- 3) Remove the System Master disk, insert a blank, unformatted disk, and type INIT HELLO. Then press the return key.
- 4) When the cursor appears, label the disk "*inCider* programs disk #1."

TYPING IN PROGRAMS

Follow these general guidelines to type in **Applesoft BASIC programs**:

- Put your programs disk into drive 1 (the internal drive on the IIc) and turn on your

computer. When the Applesoft prompt] appears, type NEW (to clear memory) and press the return key.

- Type the line number and the rest of the line exactly as they appear in the magazine. Lines longer than the width of the screen display automatically jump to the next line. Once you have entered the entire program line, hit the return key. Do this for each line.
- Save the program to disk—even before you run it—so you won't accidentally lose it. Type SAVE *file name* (file name is the program's name) and press the return key.
- Now type RUN. A syntax error indicates a typing error. The simplest way to correct it is to retype the entire line. The computer automatically replaces the old line with the new one.
- Save the error-free program.

Many programs in *inCider* use **machine-language routines** and **shape tables**, which consist of hexadecimal RAM addresses followed by the hex code (E500—A9 04 30 65 FA 8C 1B 09, for example). To type them in, follow the guidelines below:

- Turn on your computer with your programs disk in drive 1. When the Applesoft prompt] appears, type CALL -151 (use a minus sign) and hit the return key. An *, the monitor prompt, replaces the].
- Type in the first address of the program (the first four characters in the listing), followed by a colon (*not* the minus sign) and the hex numbers. See the example below:

```
E500:A9 04 30 65 FA 8C AB 09
```

Then hit the return key.

- For subsequent lines, just type a colon and the hex bytes, and press the return key.
- To check your typing before you save the listing, type in the starting address and hit the return key twice. This displays the first line. Additional lines appear each time you press the return key. To change a line, just retype it using the address and a colon.
- When the listing is correct, type 3D0G and hit the return key. Type BSAVE *file name*, Aa, L/ (a is the starting address, l the length). A \$ should precede hex values. The address and length parameters are always published with the program.

Now you can type in *inCider's* programs. Consult your manual for more detailed information. ■

22 unprotected disks for your Apple® II. Each under \$60. Call now for a free catalog.

Summer/Fall 1985 Catalog: Dial toll free 1-800-227-3800 ext. 1607 (24 hours).

Ad Number 223 Fall 1985

EXTRA K™ **NEW!**

\$39.95 (Apple IIc or 128K IIe: DOS 3.3 & ProDOS)

Put your 128K to work! Even with 128K of memory, Applesoft programs, pictures and variables only access 48K. The Extra K disk lets you utilize ALL of your 128K speed, capacity & muscle.

Extra Variables: Your Applesoft programs can function undisturbed in main memory while all variables, strings and other data reside in your extra 64K.

Extra Apple: Have TWO 64K APPLES and programs in memory and switch between them at will. You can even have a ProDOS Apple and a DOS 3.3 Apple in memory and swap files back and forth.

Extra-Fast Copies: Extra K's nibble copier copies and verifies unprotected disks in 35 seconds!

Extra Features: Create new "dual personality" ProDOS/3.3 disks. MANY MORE 128K UTILITIES.

Extra Screens: Store all kinds of images in memory and display any one (all or part) instantly.



Call several pictures per second to the screen!

10 PRINT CHR\$(21); COLOR=2;
FOR X=0 TO 39 STEP 2: FOR Y=1
TO 47 STEP 2: Z=Z+0: PLOT
X:Z:Y: NEXT Y,X

20 POKE 37,255

GOSUB 94

BEAGLE GRAPHICS

\$59.95 (Apple IIc or 128K IIe: DOS 3.3 & ProDOS)

Double Hi-Res: Access 16 hi-res colors and 560 (horizontal) x 192 (vertical) pixels (twice normal resolution) on your Apple IIc or 128K Apple IIe.

For the Artist: Draw, fill and label double hi-res pictures using just the keyboard, or your Apple-Mouse™, joystick, Koala Pad™ or Graphics Tablet. Easy-to-use CUT & PASTE features make manipulations easy. Any image section may be re-located.

For the Programmer: 33 new commands for drawing, filling and manipulating double-res images: convert normal programs & pictures to double-res, save/load image sections, compress pix to 1/3 disk space, make double-res "slide shows"...

Great Reviews: See Jan-85 A-Plus Magazine.

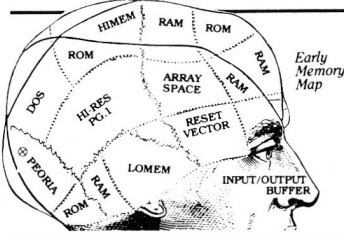

DOUBLE-TAKE™

\$34.95 (any version of Apple II: DOS 3.3 & ProDOS)

2-way Scrolling: Program listings and disk catalogs scroll up and down, making file names and program lines easier & faster to find. Machine language listings & hex-ascii dumps scroll 2 ways too.

Better List Format: Each Applesoft program statement on a new line for faster program reading.

Variable Display: Print all of a program's variables in the order used, with current values. Or alphabetize every variable and display with line numbers.

Plus: AUTO-LINE-NUMBER, improved Renumber, Hex-Dec Convert, eliminate/re-define cursor...

Beagle GAMES

I. O. SILVER™

\$29.95 (any version of Apple II)

Hi-Res Strategy: I. O. SILVER is both a thinking person's strategy game and a fast-action arcade game. Excellent high-speed animation and action.

BEAGLE BAG™

\$29.50 (any version of Apple II)

Voted by Apple software buyers to "Top-30 Most Popular" list (all categories), Beagle Bag is one of the best Apple game bargains on the market today.

PRO-BYTER™ **NEW!**

\$34.95 (Apple IIe/IIc or 64K II+; ProDOS)

ByteZap Pro: All NEW—Inspect ProDOS and DOS 3.3 disks at the byte level. Make changes and disk/program repairs that are normally impossible.

Disk Search: Find any word or phrase on a disk or in a specified file. Repair zapped disk bytes that might cause malfunction. Instant disk maps too.

Customize Disks: Easy instructions show how to make changes to disks, programs, and DOS itself.

Machine Language Sort: One CALL in an Applesoft program will alphabetize a list of words—super-fast! Sorts string-arrays—A\$(1), A\$(2), etc.

Converter: Changes any Applesoft program line to machine code that can be executed with a CALL.

Text Typers: See or print ProDOS text files immediately without having to boot your word processor.

More: Put time & date of save in your catalogs. Catalog ALL directories on any ProDOS disk. Make any Applesoft command work like any other...

Machine Language Editor: Type in programs from magazines, and insert and delete at will (no mach. lang. knowledge required). 2-way-scroll memory scanner too. Very useful & educational.

Plus ALL-NEW APPLE TIPS! How to use memory like an extra disk drive. How to disable the LIST command so it says "File Locked". How to disable or swap ANY command. How to rename "Startup", How to Personalize ProDOS catalogs...



GPLE™

\$49.95 (any version of Apple II: DOS 3.3 & ProDOS)

THE Apple Program Editor: GPLE is our "Global Program Line Editor", THE most popular, efficient way to edit Applesoft programs. GPLE works like a word processor for Basic program lines.

Insert and Delete: Now you can quickly make changes to your programs. No more awkward "escape-editing" to make changes. No more hassles with extra spaces in quote statements. No more slow "cursor-tracing" to the end of a line.

Search and Replace: Find every occurrence of a string or variable in your programs. Or replace any word with any other. For example, change all X's to ABC's, or all "HORSE" strings to "COW".

Function Keys: Define your own Apple "function keys". For example, ESC-1 can Catalog drive 1, ESC-N can clear the screen and type your name and address, etc. Customize your Apple with a set of functions that perform any set of tasks you want.

D CODE™

\$39.95 (any version of Apple II: DOS 3.3 & ProDOS)

Program Packer: D Code squeezes wasted and unused bytes out of Applesoft programs, saving valuable memory and increasing speed & efficiency.

Automatically combine program lines, shorten variable names and/or remove REMarks. Uncover wasted program lines that can't possibly be executed.

Auto-Proofreader: Typing errors are caught as you type, and before someone runs your program. Or you can simply type "CHECK" to scan an entire program and uncover potential crashes.

Super-Trace: When a program stops or crashes, type "DUMP" to see the last 10-10,000 statements and line numbers that were executed, in the order executed—an instant program history.

"Live" tracing too, with each executing statement, line no. and selected variable value in a window at the bottom of screen.

Breakpoints: D Code lets you set up de-bug "breakpoints" so your program stops when you want it to. For example, you can ask that your program be stopped when X gets set to 99, or the 3rd time a particular statement is encountered.

Lightning-Fast Find! Find strings & variables fast—large programs searched in about 2 seconds! This feature alone is worth the price of D Code.

GPLE Compatible: D Code remains "transparent" to your programs and is fully-compatible with Beagle's GPLE, Double-Take, ProntoDOS, etc.

Your program runs up here.

Lines & VARIABLES traced down here.

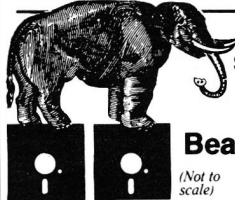

Most software stores carry Beagle Bros disks.

PRONTO-DOS™

\$29.50 (any version of Apple II: DOS 3.3)

Triple-speed DOS 3.3: ProntoDOS lets you load and save files at three-times normal speed. Hi-res images, for example, load in under 3 seconds.

More memory & disk space: Create high-speed bootable disks with 15 extra sectors of space. Move DOS 3.3 (if 64K) for an extra 10K of memory.

TYPE command: Displays text file contents.

TRIPLE-DUMP™

\$39.95 (any version of Apple II: DOS 3.3 & ProDOS)

Print any Apple Image: Triple-Dump lets your dot matrix graphics-capable printer print:

1. Hi-Res and Double Hi-Res graphics
2. Lo-Res and Double Lo-Res graphics
3. 40- and 80-Column text screen text

All kinds of Apple images can be transferred to your printer with absolutely no programming knowledge. OR you can call Triple-Dump's print routines from within your own Applesoft Basic programs.

Special Effects: Triple-Dump lets you select from a full range of special graphic effects: crop, rotate, magnify, compress, adjust density, etc.

GIANT BANNERS too: Print big signs and messages (8 1/2" high letters) on ANY kind of printer.

```
0 HOME
1 FOR X=1 TO 15
2 S=PEEK(49200+00000): NEXT
3 N=INT(RND(1)*5)+48
4 POKE 2075:N: POKE 2081,10-N
5 VTAB 9: LIST 1-2: GOTO 1
```



APPLE MECHANIC

\$29.50 (any version of Apple II: DOS 3.3)

Hi-Res Shape Animation: Your drawings are converted into "shape tables" so your programs can perform animation with Apple's built-in Draw & Xdraw commands. List and Learn disk demos teach how to create your own animated hi-res programs.

"Use Apple Mechanic routines & fonts in your programs without fee."

Hi-Res Display Type: SIX proportionally spaced hi-res screen-display fonts (both large and small) are included on the Apple Mechanic disk—

WESTERN: KL
apple: ABCDE
STENCIL: ABC

26 additional fonts available on our Apple Mechanic Typefaces™ disk (\$20.00).

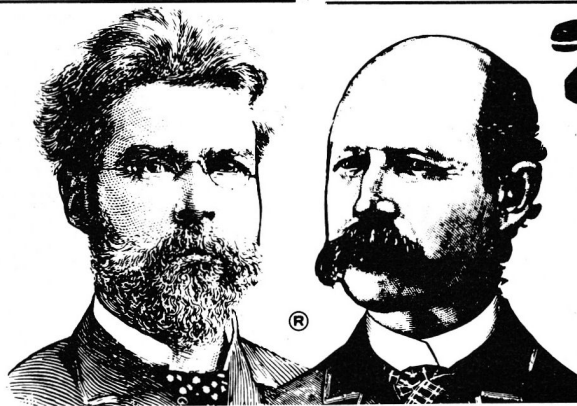

Beagle Bros MICRO SOFTWARE

The Apple Programmer's Best Friend

3990 OLD TOWN AVENUE, SUITE 102C
SAN DIEGO, CA 92110 PHONE 619-296-6400



Visa/MasterCard/COD, order Toll Free
All 50 States/24 Hours (orders only)

1-800-227-3800 x1607

Beagle Bros products are on the shelves at your local Apple Software Store.

We also ship FAST via First Class Mail:

- | | |
|---|---|
| <input type="checkbox"/> Alpha Plot . . . \$39.50 | <input type="checkbox"/> Fatcat . . . \$34.95 |
| <input type="checkbox"/> Apple Mechanic 29.50 | <input type="checkbox"/> Flex Type . . . 29.50 |
| <input type="checkbox"/> A.M.Typefaces 20.00 | <input type="checkbox"/> Frame-Up . . . 29.50 |
| <input type="checkbox"/> Beagle Bag . . . 29.50 | <input type="checkbox"/> GPLE . . . 49.95 |
| <input type="checkbox"/> Beagle Basic . . . 34.95 | <input type="checkbox"/> I. O. Silver . . . 29.95 |
| <input type="checkbox"/> Beagle Graphics 59.95 | <input type="checkbox"/> Pro-Byter . . . 34.95 |
| <input type="checkbox"/> D Code . . . 39.95 | <input type="checkbox"/> ProntoDOS. 29.50 |
| <input type="checkbox"/> DiskQuik . . . 29.50 | <input type="checkbox"/> Silicon Salad 24.95 |
| <input type="checkbox"/> DOS Boss . . . 24.00 | <input type="checkbox"/> Tip Disk#1. . . 20.00 |
| <input type="checkbox"/> Double-Take . . . 34.95 | <input type="checkbox"/> Triple-Dump 39.95 |
| <input type="checkbox"/> Extra K . . . 39.95 | <input type="checkbox"/> Utility City . . . 29.50 |

ADD \$1.50 1ST CLASS SHIPPING (any size order).
COD add \$3.00 / Calif. add 6% / Overseas add \$4.00

NAME _____

ADDRESS _____

ZIP _____

VISA/MCARD# _____

EXPIRATION DATE _____



MAIL DIRECTLY TO BEAGLE BROS.
We process all orders IMMEDIATELY.

Getting into Shapes

Listings 1 and 2. Text on p. 24.

Listing 1. TABLE.CREATOR.

```
10 REM THIS PROGRAM CREATES DEMO.SHAPES
20 FOR N = 0 TO 1441: READ P: POKE 36865 + N,P: NEXT
30 DATA 14,0,30,0,63,1,114,1,165,1,216,1,123,2,30,3,81,3,132,
  3,67,4,118,4,169,4,220,4,63,5,9,9,9,9,9,9,13,9,9,9,9,17,27,27,
  27,27,27,59,27,27,27,27,27,19,9,9,9,9,9,9
40 DATA 13,9,9,9,9,17,27,27,27,27,63,31,27,27,27,27,19,9,9,
  9,9,9,45,41,13,9,9,9,17,27,27,27,27,63,27,59,31,27,27,27,
  19,9,9,9,9,45,9,9,41,13,9,9,17,27,27,27,63,27,27
50 DATA 27,59,31,27,27,19,9,9,9,45,9,9,9,9,41,13,9,17,27,27,63,
  27,27,27,27,27,59,31,27,19,9,45,45,9,9,9,9,9,41,45,21,27,
  27,63,27,27,27,27,59,31,27,19,9,9,9,45,9,9
60 DATA 9,9,41,13,9,17,27,27,27,63,27,27,27,59,31,27,27,19,9,
  9,9,9,45,9,9,41,13,9,9,17,27,27,27,63,27,59,31,27,27,27,
  19,9,9,9,9,9,45,41,13,9,9,9,17,27,27,27,63
70 DATA 31,27,27,27,27,19,9,9,9,9,9,9,13,9,9,9,9,17,27,27,27,
  27,27,59,27,27,27,27,19,9,9,9,9,9,9,13,9,9,9,9,17,27,27,27,
  27,27,59,27,27,27,27,19,9,9,9,9,9,9
80 DATA 9,9,9,9,9,17,27,27,27,27,27,27,27,27,27,27,19,0,9,9,
  9,9,17,27,27,27,27,19,9,41,45,13,17,27,59,63,31,19,9,41,45,
  13,17,27,59,63,31,19,9,41,45,13,17,27,59,63,31,19,9
90 DATA 41,45,13,17,27,59,63,31,19,0,9,9,9,9,17,27,27,27,
  19,9,9,9,45,53,63,63,27,27,19,9,9,41,45,21,59,63,31,27,19,9,
  9,45,45,17,27,63,63,27,19,9,41,45,13,17,27,59,63,31,19
100 DATA 0,9,9,9,9,17,27,27,27,27,19,45,45,9,9,17,27,27,27,63,
  55,41,45,13,9,17,27,27,59,63,23,9,45,45,9,17,27,27,63,63,
  19,9,41,45,13,17,27,59,63,31,19,0,9,9,9,9,9,9,9,9
110 DATA 17,27,27,27,27,27,27,27,19,9,9,9,9,9,9,9,9,17,27,
  27,27,27,27,27,27,19,13,9,9,9,9,9,9,9,17,27,27,27,27,27,
  27,27,27,55,41,13,9,9,9,9,9,9,17,27,27,27,27,27
120 DATA 27,27,63,19,9,41,13,9,9,9,9,9,17,27,27,27,27,27,27,63,
  31,19,9,41,41,13,9,9,9,9,17,27,27,27,27,63,27,31,19,9,41,
  9,41,13,9,41,45,17,59,31,63,27,63,27,27,31,19,9,41
130 DATA 45,45,45,45,45,45,53,27,27,27,27,27,27,27,63,19,41,
  13,9,9,9,9,9,9,17,27,27,27,27,27,27,27,55,0,9,9,9,9,9,9,
  9,9,9,17,27,27,27,27,27,27,27,19,9,9,9,9,9,9,9,9,9,9,9
140 DATA 9,17,27,27,27,27,27,27,27,19,9,9,9,9,9,9,9,9,17,27,
  27,27,27,27,27,27,19,9,9,9,9,9,9,9,9,17,27,27,27,27,27,
  27,27,19,9,9,9,9,9,9,9,17,27,27,27,27
150 DATA 27,27,27,27,19,9,9,9,9,9,9,9,17,63,63,27,27,27,27,
  27,27,19,9,9,9,9,9,9,41,45,21,27,63,63,27,27,27,27,27,19,9,
  9,9,9,41,45,13,17,27,27,63,63,27,27,27,27,19,9
160 DATA 9,45,9,41,45,13,9,17,27,27,27,63,63,63,31,19,0,9,
  9,9,9,17,27,27,27,27,19,9,9,9,9,17,27,27,27,19,9,9,9,9,17,
  27,27,27,27,19,9,9,9,9,17,27,59,31,27,19,9,41
170 DATA 45,9,17,27,59,31,27,19,0,9,9,9,9,17,27,27,27,27,19,
  9,9,9,9,17,27,27,27,27,19,9,9,9,9,17,27,27,27,19,9,9,9,
  9,17,27,27,59,31,19,9,9,45,13,17,27,59,31,19,0
180 DATA 45,45,45,45,45,45,45,45,45,45,45,45,45,45,45,45,45,
  45,53,63,63,63,63,63,63,63,63,63,63,63,63,63,63,63,63,63,63,
  55,45,45,45,45,45,45,45,45,45,45,45,45,45,45,45,45,45,53,
  63,63,63
190 DATA 63,63,63,63,63,63,63,63,63,63,63,63,63,63,63,55,
  45,45,45,45,45,45,45,45,45,45,45,45,45,45,45,45,45,45,53,
  63,63,63,63,63,63,63,63,63,63,63,63,63,63,63,63,63,63,55,
  45,45,45,45,45
200 DATA 45,45,45,45,45,45,45,45,45,45,45,45,53,63,63,63,
  63,63,63,63,63,63,63,63,63,63,63,63,63,63,63,55,45,45,45,
  45,45,45,45,45,45,45,45,45,45,45,45,45,45,45,53,63,63,63,
  63,63,63,63,63,63
210 DATA 63,63,63,63,63,63,63,63,63,55,0,9,9,9,9,17,27,27,27,
  27,19,9,9,9,9,17,27,27,27,27,19,9,9,13,9,17,27,31,31,19,
  9,13,9,13,17,27,27,31,31,19,9,9,13,9,17,27,27,27
220 DATA 19,0,9,9,9,9,17,27,27,27,27,19,9,9,9,9,17,63,63,27,
  27,19,9,9,41,45,53,63,63,63,27,19,9,41,45,45,53,63,63,63,
  31,19,9,41,45,13,17,27,59,63,31,19,0,9,9,9,9,17,27,27
230 DATA 27,27,19,9,9,9,9,17,27,27,27,63,55,45,45,13,9,17,27,
  27,63,63,55,45,45,45,13,17,27,59,63,63,55,9,41,45,13,17,27,
  59,63,31,19,0,9,9,9,9,9,9,17,27,27,27,27,27,19,9,9
240 DATA 41,13,13,9,21,27,27,27,27,27,27,19,9,41,9,9,9,13,17,
  27,27,31,27,59,27,19,9,9,41,45,13,9,17,27,27,59,63,31,27,19,
  41,9,41,45,13,9,17,27,27,59,63,31,27,19,9,9,13,9,41,9
250 DATA 21,27,59,27,27,27,31,19,9,9,9,13,9,9,17,27,27,27,27,
```

```
27,27,19,0,9,9,41,9,9,9,17,31,27,27,27,63,27,19,9,13,9,9,9,
9,17,27,27,27,27,59,19,41,13,9,9,41,13,17,27,27
260 DATA 31,27,27,27,19,9,9,9,9,41,45,17,27,27,27,27,27,19,
9,41,45,9,9,9,17,27,31,27,27,27,27,19,41,9,9,9,9,41,17,27,27,
27,27,27,59,23,9,9,9,9,45,9,49,27,27,27,27,27,27
270 DATA 19,0
280 PRINT CHR$(4)""BSAVE DEMO.SHAPES,A36865,L1442"
```

Listing 2. CHICKEN.LITTLE.

```
10 PRINT CHR$(4)""BLOAD DEMO.SHAPES,A36865"
20 HIMEM: 36864
30 LOMEM: 16384
40 POKE 232, PEEK (43634) : REM USING PRODOS - 40
  POKE 232, PEEK(48825)
50 POKE 233, PEEK (43635) : REM USING PRODOS - 50
  POKE 233, PEEK(48826)
60 HOME
70 HGR : SCALE = 1
80 HCOLOR = 3
90 FOR X = 0 TO 279 STEP 30
100 DRAW 9 AT X,150
110 NEXT
120 DRAW 9 AT 120,140
130 X = 135
140 Y = 130
150 P = 2
160 DRAW P AT X,Y
200 XX = INT ( RND (1) * 270): IF XX < 15 OR XX > 265
  THEN 200
210 FOR YY = 0 TO 140 STEP 15
220 DRAW 1 AT XX,YY
230 KB = 0:F = FRE (0)
240 GOTO 500
250 GOSUB 1000
260 XDRAW 1 AT XX,YY
270 NEXT
280 GOTO 5000
500 K = PEEK (49152)
510 IF K > 127 THEN KB = K - 128: POKE 49168,0:
  GOTO 250
520 KB = 0: GOTO 250
1000 IF KB = 8 AND P = 11 THEN XDRAW P AT X,Y:P = 3:
  DRAW P AT X,Y: RETURN
1010 IF KB = 8 AND P = 3 THEN XDRAW P AT X,Y:P = 2:
  DRAW P AT X,Y: RETURN
1020 IF KB = 8 AND P = 2 THEN XDRAW P AT X,Y:P = 4:
  DRAW P AT X,Y: RETURN
1030 IF KB = 8 AND P = 4 THEN XDRAW P AT X,Y:P = 12:
  DRAW P AT X,Y: RETURN
1040 IF KB = 21 AND P = 12 THEN XDRAW P AT X,Y:P =
  4: DRAW P AT X,Y: RETURN
1050 IF KB = 21 AND P = 4 THEN XDRAW P AT X,Y:P = 2:
  DRAW P AT X,Y: RETURN
1060 IF KB = 21 AND P = 2 THEN XDRAW P AT X,Y:P = 3:
  DRAW P AT X,Y: RETURN
1070 IF KB = 21 AND P = 3 THEN XDRAW P AT X,Y:P =
  11: DRAW P AT X,Y: RETURN
1080 IF KB = 32 THEN GOSUB 2000: RETURN
1090 RETURN
2000 IF P = 2 THEN 2100
2010 IF P = 3 THEN 2200
2020 IF P = 4 THEN 2300
2030 IF P = 11 THEN 2400
2040 IF P = 12 THEN 2500
2100 FOR SY = 120 TO 0 STEP - 20
2110 DRAW 10 AT 135,SY
2120 Z1 = ABS (XX - 135):Z2 = ABS (SY - YY): IF Z1 < 10
  AND Z2 < 10 THEN XDRAW 10 AT 135,SY: GOTO 4000
2130 XDRAW 10 AT 135,SY
2140 NEXT : RETURN
2200 T = 1
2210 FOR SY = 115 TO 0 STEP - 20
2220 DRAW 10 AT 140 * T,SY
2230 Z1 = ABS (140 * T - XX):Z2 = ABS (SY - YY):
  IF Z1 < 10 AND Z2 < 10 THEN XDRAW 10 AT 140 *
  T,SY: GOTO 4000
```

Listing continued.

Listing continued.

```
2240 XDRAW 10 AT 140 * T,SY
2250 T = T * 1.1
2260 NEXT : RETURN
2300 FOR SY = 120 TO 0 STEP - 20
2310 DRAW 10 AT (SY * 1.1),SY
2320 Z1 = ABS (SY * 1.1 - XX):Z2 = ABS (SY - YY):
      IF Z1 < 10 AND Z2 < 10 THEN XDRAW 10 AT SY *
      1.1,SY: GOTO 4000
2330 XDRAW 10 AT (SY * 1.1),SY
2340 NEXT : RETURN
2400 FOR SX = 145 TO 270 STEP 20
2410 DRAW 10 AT SX,120
2420 Z1 = ABS (SX - XX):Z2 = ABS (120 - YY):
      IF Z1 < 10 AND Z2 < 10 THEN XDRAW 10 AT SX,120:
      GOTO 4000
2430 XDRAW 10 AT SX,120
2440 NEXT : RETURN
2500 FOR SX = 125 TO 0 STEP - 20
2510 DRAW 10 AT SX,120
2520 Z1 = ABS (SX - XX):Z2 = ABS (120 - YY):
      IF Z1 < 10 AND Z2 < 10 THEN XDRAW 10 AT SX,120:
      GOTO 4000
2530 XDRAW 10 AT SX,120
2540 NEXT : RETURN
4000 XDRAW 1 AT XX,YY
4010 SC = SC + 140 - YY
4020 VTAB 22: PRINT "SCORE: ";SC
4030 FOR QQ = 1 TO 200: NEXT
4040 POP : POP : GOTO 200
5000 DRAW 13 AT X,Y
5010 FOR QQ = 1 TO 300: NEXT
5020 DRAW 14 AT X,Y
5030 FOR QQ = 1 TO 300: NEXT
5040 VTAB 22: PRINT "YOUR FINAL SCORE IS: ";SC
```

End of listing.

**If you live in Boston
and you're
interested in
personal computing,
we have a free
program for you.**

*All you need is
a radio and a phone!*

Participate in "Computerworld," the information exchange on personal computing, 5 to 7 PM, every Sunday night on WDLW radio, 1330 on your AM dial.

COMPUTERWORLD

**"You Couldn't Have Made
It Any Simpler!
Now Everyone Can Afford
To Go On-Line"**

*Shaun Ralston on-line from
Personal Computing Magazine.*

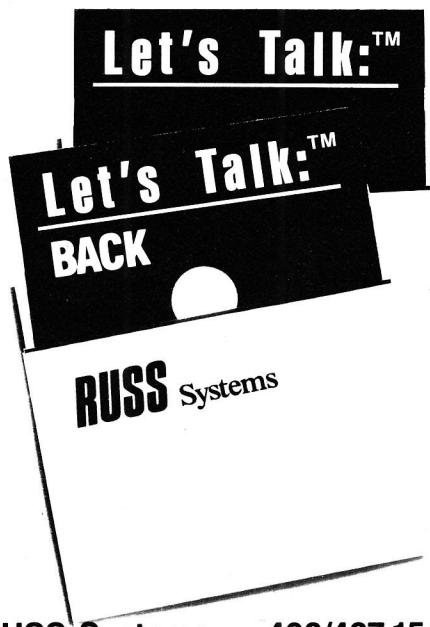

RUSS Systems 408/427-1540
320 Dufour, Santa Cruz, CA 95060

TURN YOUR APPLE INTO A FULL TIME PARTNER

Let's Talk:™ is the electronic link that puts your information on-line. Now your computer can advertise and support products and services, list catalogues, and accept orders. Provide electronic mail, and conferencing any time day or night from your home, office, or school.

You decide what goes on-line to callers and all they need to get your message, or send you one, is any computer and a modem. Password any file for private access.

Let's Talk:™ \$125.00

AUTO ANSWER

DIAL FOR DATA

Let's Talk:™ BACK . . . is the access software your IIc or IIe is looking for.

Dial, send or receive files, record and print simultaneously at the press of a key. Store lengthy logon sequences and execute them fast and easy.

It's about time . . . you don't have to be an expert to talk back.

Let's Talk:™ BACK \$49.00

DIAL OUT

We provide the finest Editor and Disk Utilities available in communication software.

- IIc or IIe 128k or Apple III

Have your computer call for a demonstration 408/427-0310 (data)

24 hour customer support available.

Let's Talk™ DATABOARDS

Master of the Game

Program listing. Text on p. 34.

Program listing. MENACE.

```
program menace;
(* A program to play tic-tac-toe. This program begins completely
ignorant of the game and uses matchbox learning to improve its
play from observation of its experience. *)

uses applestuff;

type
chrset = set of char;      (* Acceptable keyboard responses *)
gameboard = array[1..3,1..3] of char; (* Tic-tac-toe board. *)
gamestatus = (play,win,lose,draw);
(* Status at various points in game *)
ptrnptr = ^pattern;
memory = record           (* Stores one move of the game *)
  ptrnplay:ptrnptr;
  (* Points to the pattern encountered *)
  move:array[1..2] of 1..3
  (* in play. Row and column played. *)
end;
pattern = record          (* Pattern stored in the linked list. *)
  position:gameboard;
  (* Game board pattern. Weights of *)
  weight:packed array[1..3,1..3] of integer;
  (* each move in the *)
  nextptrn:ptrnptr      (* pattern. Pointer to the next *)
end; (* pattern. *)

var
valid:chrset;      (* Set of acceptable keystrokes for getkey. *)
status:gamestatus; (* Stores game status. *)
pointer1,pointer2,pointer3:ptrnptr; (* Pointers to the three lists. *)
patterncount:packed array[1..3] of 0..255; (* Counts patterns
stored. *)
board:gameboard;   (* Stores current game position. *)
firstplay:integer; (* Stores the first play. *)
firstmove:array[1..3] of integer;
(* Weights assigned to first moves. *)
history:array[1..3] of memory;
(* Patterns and moves of current game. *)
games,wins,losses,draws:integer;

procedure initmenace;
(* Initialize values and output screen before *)
var (* the first game begins. *)
  i,j:integer;
begin (* initmenace *)
  randomize;
  games := 0;
  wins := 0;
  losses := 0;
  draws := 0;
  for i := 1 to 3 do begin
    patterncount[i] := 0;
    firstmove[i] := 4
  end;
  pointer1 := nil;
  (* Pointers to the three linked lists. Initially *)
  pointer2 := nil; (* the three lists are empty. *)
  pointer3 := nil;
  page(output);
  writeln('Watchit! Here comes MENACE!');
  gotoxy(15,10);write('Board');
  gotoxy(15,11);write('!!'); (* Place the game board on the crt. *)
  gotoxy(15,12);write('----');
  gotoxy(15,13);write('!!');
  gotoxy(15,14);write('----');
  gotoxy(15,15);write('!!');

(* GOTOXY(44,10);WRITE('Pattern
GOTOXY(45,11);WRITE('!!
Rotate/Reflect');
!!');
```

```
GOTOXY(45,12);WRITE('----');
GOTOXY(45,13);WRITE('!!');
GOTOXY(45,14);WRITE('----');
GOTOXY(45,15);WRITE('!!');
```

```
gotoxy(5,20);write('Patterns, level 3:',patterncount[1]:3);
gotoxy(5,21);write('Patterns, level 5:',patterncount[2]:3);
gotoxy(5,22);write('Patterns, level 7:',patterncount[3]:3);
gotoxy(5,23);write('Remaining memory: ',memavail:5)
end; (* initmenace *)
```

```
procedure writemove(row,col:integer;ch:char);
(* Write the character in the *)
begin (* writemove *) (* row and column of the crt display. *)
  gotoxy(13 + 2*col,9 + 2*row);write(ch);
  board[row,col] := ch
end; (* writemove *)
```

```
procedure initboard;
(* Initialize values at the beginning of each game. *)
```

```
var
  i,j:integer;
begin (* initboard *)
  games := games + 1;
  gotoxy(5,5);write('Game number: ',games:3);
  gotoxy(5,6);write('Wins: ',wins:3);
  gotoxy(5,7);write('Losses: ',losses:3);
  gotoxy(5,8);write('Draws: ',draws:3);
  status := play;
  for i := 1 to 3 do begin
    history[i].ptrnplay := nil;
    for j := 1 to 3 do begin
      board[i,j] := ' ';
      writemove(i,j, ' ');
    end
  end
end; (* initboard *)
```

```
function rndchoice(maxval:integer):integer;
(* Generate a random integer *)
var temp,rand:integer;
begin (* rndchoice *) (* between 1 and maxval. *)
  temp := (32767 div maxval) + 1;
  repeat
    rand := random div temp
  until rand < maxval;
  rndchoice := rand + 1
end; (* rndchoice *)
```

```
function getkey(valid:chrset):char;
(* Read a character contained in the *)
var (* set valid from the keyboard. *)
  ch:char;
begin (* getkey *)
  repeat
    if keypress then read(keyboard,ch)
  until ch in valid;
  getkey := ch
end; (* getkey *)
```

```
(* Delay loop to slow up the column 41 to 80 display.
For a slow display, change the loop to FOR I := 1 TO 250 DO *)
(*
PROCEDURE WAIT;
VAR
  I:INTEGER;
BEGIN
  FOR I := 1 TO 5 DO
  END;
*)
```

```
function won:boolean; (* returns true if any column, row or
diagonal *)
var (* is filled with identical non-blank characters. *)
  i:integer;
  temp,wontest:boolean;
begin (* won *)
```

Listing continued.

Listing continued.

```
(* GOTOXY(40,0);WRITE('ENTERING WON. ');
WAIT; *)
wontest = false;
for i:= 1 to 3 do begin (* Test each row. *)
temp:= (board[i,1]=board[i,2]) and (board[i,2]=board[i,3]);
wontest:= wontest or ((board[i,1]<>' ') and temp)
end;
for i:= 1 to 3 do begin (* Test each column. *)
temp:= (board[1,i]=board[2,i]) and (board[2,i]=board[3,i]);
wontest:= wontest or ((board[1,i]<>' ') and temp)
end;
(* Test the diagonals. *)
temp:= (board[1,1]=board[2,2]) and (board[2,2]=board[3,3]);
wontest:= wontest or ((board[2,2]<>' ') and temp);
temp:= (board[1,3]=board[2,2]) and (board[2,2]=board[3,1]);
won:= wontest or ((board[2,2]<>' ') and temp)
end; (* won *)
```

```
function done:boolean; (* Interrogates user for end of game. *)
var
```

```
valid:set of char;
answer:char;
begin (* done *)
gotoxy(10,17);writeln('Press space to continue, ');
gotoxy(10,18);writeln('press Q to quit. ');
valid:= [' ', 'q', 'Q'];
answer:= getkey(valid);
if answer<>' ' then done:= true else done:= false;
gotoxy(10,17);writeln(' ');
gotoxy(10,18);writeln(' ');
end; (* done *)
```

```
(*
PROCEDURE WRITEB(FLAG:BOOLEAN);
BEGIN
IF FLAG THEN WRITE('True. ');
ELSE WRITE('False. ');
END;
*)
```

```
procedure searchpattern(var srchptr:ptrnptr;level:integer);
var (* Search the list indicated by srchptr for a match. *)
rotate:0..3; (* Number of 90 degree rotations of the pattern. *)
tempch:char;
lastptr:ptrnptr;
mirror,finished,temp:boolean;
function match(aboard:gameboard;var rotate:integer;var mirror:boolean):boolean;
var (* Rotate and reflect the pattern in memory to see *)
i,j:integer; (* if it matches the current position. *)
begin
```

```
(* GOTOXY(40,0);WRITE('ENTERING MATCH. ');
WAIT; *)

mirror:= false;

(* IF (rotate = 0) and (not mirror) THEN
FOR i:= 1 TO 3 DO
FOR j:= 1 TO 3 DO BEGIN
GOTOXY(43 + 2*j,9 + 2*i);WRITE(aboard[i,j]);
END;
GOTOXY(40,6);WRITE('Rotated ',90*rotate:3,' degrees. Image: ');
WRITEB(mirror);GOTOXY(40,7);WRITE('Match: '); *)

temp:= true;
for i:= 1 to 3 do (* Compare pattern in memory to current
position. *)
for j:= 1 to 3 do (* BEGIN *)
temp:= temp and (board[i,j]=aboard[i,j]);

(* GOTOXY(62 + 2*j,9 + 2*i);WRITE(aboard[i,j])
END;
GOTOXY(47,7);WRITEB(temp);
WAIT; *)
```

```
if not temp then begin
mirror:= true;
temp:= true;
for i:= 1 to 3 do (* Compare reflected pattern to current
position. *)
for j:= 1 to 3 do (* BEGIN *)
temp:= temp and (board[i,j]=aboard[i,4-j]);

(* GOTOXY(62 + 2*j,9 + 2*i);WRITE(aboard[i,4-j])
END *)
```

```
end;

(* GOTOXY(69,6);WRITEB(mirror);
GOTOXY(40,7);WRITE('Match: ');WRITEB(temp);
WAIT; *)

if not temp and (rotate<3) then begin
tempch:= aboard[1,3]; (* Rotate the pattern 90 degrees
and *)
aboard[1,3]:= aboard[1,1]; (* try again. *)
aboard[1,1]:= aboard[3,1];
aboard[3,1]:= aboard[3,3];
aboard[3,3]:= tempch;
tempch:= aboard[1,2];
aboard[1,2]:= aboard[2,1];
aboard[2,1]:= aboard[3,2];
aboard[3,2]:= aboard[2,3];
aboard[2,3]:= tempch;
rotate:= rotate + 1;
temp:= match(aboard,rotate,mirror)
end;
match:= temp
end;
procedure newpattern(var srchptr:ptrnptr;level:integer);
var (* Procedure to generate a new pattern in the list. *)
i,j,newweight:integer;
tempptr:ptrnptr;
begin
```

```
(* GOTOXY(40,0);WRITE('ENTERING NEWPATTERN. ');
WAIT; *)

new(tempptr); (* Generate a new pattern. *)
tempptr^.nxtptr:= nil;
i:= (level - 1) div 2;
if patterncount[i]=0 then (* If the list is empty, initialize the *)
case level of (* pointers to the first list elements. *)
3:pointer1:= tempptr;
5:pointer2:= tempptr;
7:pointer3:= tempptr;
end;
patterncount[i]:= patterncount[i] + 1;
gotoxy(5,19+i);write('Patterns, level',level:2,':',patterncount[i]:3);
if srchptr<>nil then srchptr^.nxtptr:= tempptr;
(* If the original *)
srchptr:= tempptr; (* list isn't empty, update the list to *)
for i:= 1 to 3 do (* include the new pattern. Set srchptr *)
for j:= 1 to 3 do (* point to the new pattern. *)
srchptr^.position[i,j]:= board[i,j]; (* Set the new pattern to *)
case level of (* the current game position. *)
3:newweight:= 3; (* Set the initial weights for this level. *)
5:newweight:= 2;
7:newweight:= 1
end;
for i:= 1 to 3 do
for j:= 1 to 3 do (* Assign the weight to available moves. *)
if srchptr^.position[i,j]= ' ' then srchptr^.weight[i,j]:= newweight
else srchptr^.weight[i,j]:= 0;
gotoxy(5,23);write('Remaining memory: ',memavail:5)
end;
procedure genmove(srchptr:ptrnptr;rotate:integer;mirror:boolean);
var (* Generate the move for the pattern indicated by
srchptr. *)
```

Listing continued.

Listing continued.

```
i,j,k,total,choice:integer;
begin (* genmove *)

(* GOTOXY(40,0);WRITE('ENTERING GENMOVE. ');
WAIT; *)

total:=0;
for i:=1 to 3 do
  for j:=1 to 3 do (* BEGIN *)
    total:=total+srchptr^.weight[i,j];

    (* GOTOXY(38+3*j,19+i);WRITE(srchptr^.weight[i,j]:3)
    END; *)

if total=0 then (* If all possible moves have been rejected, *)
  for i:=1 to 3 do (* reinitialize the weights. *)
    for j:=1 to 3 do
      if board[i,j]=' ' then begin
        srchptr^.weight[i,j]:=1;
        total:=total+1
      end;
    choice:=rndchoice(total);
    (* Generate a random number to determine move. *)

    (* GOTOXY(40,17);WRITE('Total:',total:3,' Choice:',choice:3);
    WAIT; *)

    j:=1;i:=1;
    total:=srchptr^.weight[1,1];
    while total<choice do begin (* Generate the row and column of
    the move *)
      j:=j+1; (* determined by total and choice. *)
      if j>3 then begin
        j:=1;
        i:=i+1
      end;
      total:=total+srchptr^.weight[i,j];
    end;

    (* GOTOXY(40,18);WRITE('Row:',i:2,' Col:',j:2);
    WAIT; *)

    history[(level-1) div 2].ptrnplay:=srchptr;
    (* Update the history to *)
    history[(level-1) div 2].move[1]:=i;
    (* store the pattern encountered *)
    history[(level-1) div 2].move[2]:=j;
    (* and the move played. *)
    while rotate>0 do begin
      rotate:=rotate-1; (* Rotate the row and column by 90
      degrees *)
      k:=j; (* for as many times as the original pattern *)
      j:=4-i; (* was rotated. *)
      i:=k;
    end;
    if mirror then j:=4-j; (* Generate the mirror image of
    the move. *)

    (* GOTOXY(40,19);WRITE('Row:',i:2,' Col:',j:2);
    WAIT; *)

    writemove(i,j,'X');
    end; (* genmove *)
    begin (* searchpattern *)

    (* GOTOXY(40,0);WRITE('ENTERING SEARCHPTRN. ');
    WAIT; *)

    rotate:=0;
    mirror:=false;
    if srchptr<>nil then begin
      repeat (* Search the list if it's not empty. *)
        rotate:=0;
        mirror:=false;
        finished:=match(srchptr^.position,rotate,mirror);

        if not finished then begin
          lastptr:=srchptr; (* Save the last pointer and *)
          srchptr:=srchptr^.nxtptrn (* update srchptr to the next *)
          end; (* element in the list. *)
        until finished or (srchptr=nil);
        if srchptr=nil then begin
          srchptr:=lastptr; (* If at the end of the list set *)
          newpattern(srchptr,level); (* srchptr to the last element and *)
          rotate:=0; (* generate the next element in the *)
          mirror:=false (* list. *)
        end
        else newpattern(srchptr,level);
          genmove(srchptr,rotate,mirror)
        end; (* searchpattern *)

    procedure applemove(level:integer);
    var
      srchptr:ptrnptr;
      i,j,row,col:integer;
    begin (* applemove *)

    (* GOTOXY(40,0);WRITE('ENTERING APPLEMOVE. ');
    WAIT; *)

    case level of
      1:begin
        j:=firstmove[1]+firstmove[2]+firstmove[3];
        if j=0 then begin
          j:=3;
          for i:=1 to 3 do
            firstmove[i]:=1 (* Use the weights to generate the *)
            end; (* first move of the game. *)
          i:=rndchoice();
          if i<=firstmove[1] then firstplay:=1 else
            if i<=(firstmove[1]+firstmove[2]) then firstplay:=2 else
              firstplay:=3;
          case firstplay of
            1:begin (* Play the upper left-hand corner. *)
              row:=1;
              col:=1
            end;
            2:begin (* Play the center position. *)
              row:=2;
              col:=2
            end;
            3:begin (* Play the top side. *)
              row:=1;
              col:=2
            end
          end;
          writemove(row,col,'X')
        end;
      3:begin (* Set srchptr at the beginning *)
        srchptr:=pointer1; (* of the appropriate list and *)
        searchpattern(srchptr,level) (* then begin the pattern
        search. *)
      end;
      5:begin
        srchptr:=pointer2;
        searchpattern(srchptr,level)
      end;
      7:begin
        srchptr:=pointer3;
        searchpattern(srchptr,level)
      end;
      9:begin (* Find the last empty position to play. *)
        for i:=1 to 3 do
          for j:=1 to 3 do
            if board[i,j]=' ' then begin
              row:=i;
              col:=j
            end;
          end;
        end;
      end;
    end;
  end;
end;
```

Listing continued.

Listing continued.

```
writemove(row,col,'X')
end;
end;
end; (* applemove *)

procedure humanmove;
const
  leftarrow = 8;
  rightarrow = 21;
var
  answer:char;
  answers:chrset;
  i,j:integer;
procedure lastblank(var row,col:integer);
begin (* Find the last empty cell in the game board. *)
  repeat
    col := col - 1;
    if col < 1 then begin
      col := 3;
      row := row - 1;
      if row < 1 then row := 3
    end
  until board[row,col] = ' '
end;
procedure nextblank(var row,col:integer);
begin (* Find the next empty cell in the game board. *)
  repeat
    col := col + 1;
    if col > 3 then begin
      col := 1;
      row := row + 1;
      if row > 3 then row := 1
    end
  until board[row,col] = ' '
end;
begin (* humanmove *)

  (* GOTOXY(40,0);WRITE('ENTERING HUMANMOVE. ');
  WAIT; *)

  answers := [' ',chr(leftarrow),chr(rightarrow)];
  i := 1;
  j := 1;
  if board[i,j] < > ' ' then nextblank(i,j);
  writemove(i,j,' ');
  repeat
    answer := getkey(answers);
    if answer = chr(leftarrow) then begin
      writemove(i,j,' ');
      lastblank(i,j);
      writemove(i,j,' ')
    end
    else if answer = chr(rightarrow) then begin
      writemove(i,j,' ');
      nextblank(i,j);
      writemove(i,j,' ')
    end
  until answer = ' ';
  writemove(i,j,'O')
end; (* humanmove *)

procedure tictactoe(level:integer);
begin (* tictactoe *)

  (* GOTOXY(40,0);WRITE('ENTERING TICTACTOE. ');
  WAIT;
  GOTOXY(40,5);WRITE('Entering level ',level:2,' of play. '); *)

  applemove(level);
  if won then status := lose else if level = 9 then status := draw;
  if status = play then begin
    humanmove;
    if won then status := win
  end;
  if status = play then tictactoe(level + 2)
end; (* tictactoe *)
```

```
end; (* tictactoe *)

procedure update;
var
  moveptr:ptrnptr;
  row,col,i:integer;
procedure procwin;
begin
  wins := wins + 1;
  gotoxy(5,6);write('Wins:      ',wins:3)
end;
procedure procloss;
begin
  losses := losses + 1;
  gotoxy(5,7);write('Losses:    ',losses:3)
end;
procedure procdraw;
begin
  draws := draws + 1;
  gotoxy(5,8);write('Draws:     ',draws:3);
end;
begin (* update *)

  (* GOTOXY(40,0);WRITE('ENTERING UPDATE.      ');
  WAIT; *)

  case status of
    lose: firstmove[firstplay] := firstmove[firstplay] + 3;
    win: begin
      firstmove[firstplay] := firstmove[firstplay] - 1;
      if firstmove[firstplay] < 0 then firstmove[firstplay] := 0
    end;
    draw: firstmove[firstplay] := firstmove[firstplay] + 1
  end;
  for i := 1 to 3 do begin
    moveptr := history[i].ptrnplay;
    if moveptr < > nil then begin
      row := history[i].move[1];
      col := history[i].move[2];
      case status of
        lose: moveptr^.weight[row,col] := moveptr^.weight[row,col] + 3;
        win: begin
          moveptr^.weight[row,col] := moveptr^.weight[row,col] - 1;
          if moveptr^.weight[row,col] < 0 then moveptr^.weight[row,col] := 0
        end;
        draw: moveptr^.weight[row,col] := moveptr^.weight[row,col] + 1
      end
    end
  end;
  case status of
    win: procwin;
    draw: procdraw;
    lose: procloss;
  end
end;

begin (* menace *)
  initmenace;
  repeat
    initboard;
    tictactoe(1);
    update
  until done; (* repeat *)
end. (* menace *)
```

End of listing.

The Spirit of Adventure

Listings. Text on p. 42.

Listing 1. Sample move subroutine.

```
1000 IF OJ$ = "" THEN GOSUB 10000: REM IN CASE
      DIRECTION NOT GIVEN
1010 OJ$ = LEFT$(OJ$,1)
1020 D% = 0
1030 IF OJ$ = "N" THEN D% = 1
1040 IF OJ$ = "S" THEN D% = 2
1050 IF OJ$ = "E" THEN D% = 3
1060 IF OJ$ = "W" THEN D% = 4
1065 IF OJ$ = "BACK" THEN GOSUB 1200
1070 IF D% = 0 THEN PRINT "I CAN'T GO THAT
      WAY.": RETURN
1080 IF NR%(D%,RM%) = 0 THEN PRINT "THERE IS NO
      PASSAGE THAT WAY.": RETURN
1090 IF NR%(D%,RM%) > 1000 THEN GOSUB 2000:
      REM OBSTACLE CHECKER
1100 IF NR%(D%,RM%) > 1000 THEN RETURN:
      REM OBSTACLE STILL THERE
1110 LR% = RM%: REM TO REMEMBER THE LAST ROOM
1120 RM% = NR%(D%,RM%): REM ASSIGN NEW ROOM
1130 PRINT DE$(RM%): REM ROOM DESCRIPTION
1140 RETURN
1200 FOR I = 1 TO 4: REM SEARCH FOR A PASSAGE BACK
1205 T% = NR%(I,RM%): REM TEMPORARY VARIABLE
      TO HOLD NR%(I,RM%)
1210 IF T% < 1000 GOTO 1250: REM NO OBSTACLE
      THAT WAY
1220 T% = T% - 1000
1230 GOTO 1210: REM TRY AGAIN
1250 IF T% = LR% THEN D% = I: REM YOU FOUND
      A DIRECTION
1260 NEXT I
1270 RETURN: REM TO LINE 1070. D% IS NOW
      DIRECTION BACK.
1275 REM IF D% STILL = 0 THEN NO PASSAGE
      EXISTS. THE MOVE SUBROUTINE
1280 REM WILL RETURN TO MAIN SAYING IT CAN'T GO
      THAT WAY.
<< If there are several passages leading "back" to the same
      room, this will find the one with the highest-numbered
      direction. >>
```

Listing 2. A partial obstacle-checking subroutine.

```
2000 IF NR%(D%,RM%) > 2000 GOTO 2100: REM OBSTACLE
      IS NOT A GATE
2010 PRINT "THERE IS A LOCKED GATE THAT WAY. ..."
2020 INPUT "DO YOU WANT TO OPEN IT? ";I$
2030 IF LEFT$(I$,1) = "N" THEN PRINT "CAUTION MAY BE
      WISE. ...": RETURN
2040 IF OL%(3) <> 100 THEN PRINT "YOU DON'T HAVE
      A KEY!": RETURN
<< This assumes object 3 is a key. >>
2050 PRINT "OKAY."
2060 NR%(D%,RM%) = NR%(D%,RM%) - 1000:
      REM OBSTACLE REMOVED
2065 RETURN: REM TO MOVE SUBROUTINE
2100 IF NR%(D%,RM%) > 3000 GOTO 2200:
      REM OBSTACLE IS NOT MAGIC SPELL
2110 PRINT "THERE IS A MAGIC SPELL BLOCKING
      THAT PASSAGE"
2120 IF OL%(4) = 100 THEN PRINT "WAIT A MINUTE.
      THE RING IS GLOWING!": PRINT "THE SPELL
      DISAPPEARED!": NR%(D%,RM%) = NR%(D%,RM%)
      - 2000
<< This assumes object 4 is a ring that will remove
```

the spell. >>

A more general form of line 2120 would be for the first
PRINT to be:

```
PRINT "WAIT A MINUTE. THE ";OB$(4);" IS GLOWING!"
```

With this form, you could call object 4 anything, not just a ring.

```
2130 RETURN
2200 << Subroutine for the next obstacle. >>
```

Listing 3. Sample drop subroutine.

```
5000 IF OJ$ = "" THEN GOSUB 10000: REM IN CASE
      OBJECT NOT GIVEN
5005 T% = 0
5010 FOR I = 1 TO 20: REM CHECKING ALL 20 OBJECTS
5020 IF OJ$ = OB$(I) AND OL%(I) = 100 THEN T% = I:
      REM YOU OWN IT
5030 NEXT I
5040 IF T% = 0 THEN PRINT "YOU DON'T HAVE
      ANY ";OJ$;"": RETURN
5050 OL%(T%) = RM%: REM PUT THIS OBJECT INTO
      THIS ROOM
5060 RETURN
```

Listing 4. Part of the parser.

```
<< Find VB$ and OJ$. >>
20000 IF CO$ = "" THEN PRINT "WHAT?": RETURN
20005 J = LEN(CO$) + 1: REM IN CASE NO BLANK
      FOUND IN CO$
20010 OJ$ = ""
20015 VB$ = ""
20020 FOR I = 1 TO LEN(CO$)
20025 IF MID$(CO$,I,1) = " " THEN J = I
20030 NEXT I
20040 VB$ = LEFT$(CO$,J-1)
20045 IF J < LEN(CO$) THEN OJ$ = RIGHT$(CO$,
      LEN(CO$)-J)
<< Look for abbreviations. >>
20050 IF VB$ = "N" THEN VB$ = "MOVE": OJ$ = "N"
20055 IF VB$ = "S" THEN VB$ = "MOVE": OJ$ = "S"
<< etc. >>
20070 IF VB$ = "BACK" OR VB$ = "RETURN" THEN
      VB$ = "MOVE": OJ$ = "BACK"
20075 IF VB$ = "GO" THEN VB$ = "MOVE"
<< Decide what subroutine to call. >>
20200 IF VB$ = "MOVE" THEN GOSUB 1000
20210 IF VB$ = "EAT" THEN GOSUB 3000
20220 IF VB$ = "RUN" THEN GOSUB 4000
20230 IF VB$ = "DROP" THEN GOSUB 5000
20240 IF VB$ = "TAKE" THEN GOSUB 6000
20250 IF VB$ = "QUIT" THEN GOSUB 9000
<< etc. >>
20400 RETURN
```

Listing 5. Part of the control structure.

```
100 GOSUB 40000: REM INITIALIZATION
200 PRINT "YOU ARE IN THE ";NM$(RM%);" ROOM.":
      REM START MAIN LOOP
210 INPUT "> ";CO$
220 GOSUB 10000: REM TO THE PARSER
230 IF RM% = 50 << the way out?? >> GOTO 500
<< Any other way to get out of here? >>
240 GOTO 200: REM REPEAT BASIC LOOP
500 << Count points or judge your performance. >>
510 END
```

quikLoader™

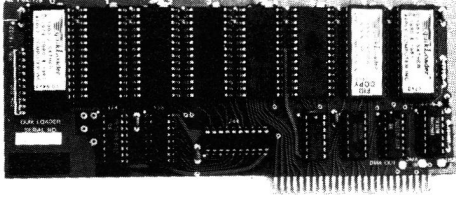

designed by Jim Sather

- **Instantly** loads DOS.
- **Instantly** loads programs.
- Stores up to 512K of programs on EPROM.
- Stores and catalogs up to 255 programs.
- Directions included to load your own software (requires EPROM programmer card).
- Plugs into any slot of the APPLE][+ or //e.
- Uses standard 27 series EPROMs up to 27512.
- Allows turnkey operation.
- Commercial programs available.
- Includes DOS, FID, COPYA, and Integer.

The benefits of quikLoader™ start when you turn on the computer. Standard DOS is instantly loaded. You may then catalog the programs available on the card by pressing **Q-reset**. Typing the index letter that appears on the left of the program name causes that program to be immediately loaded. We start your library of programs with the most popular utilities on EPROM, FID and COPYA. Now, if you have to copy a disk, you don't have to search for the master disk. You can start copying within 3 seconds after powering on.

Saving your own programs onto EPROM (Erasable Programmable Read Only Memory) is easily done, using a separate EPROM programmer, (such as the PROMGRAMER™). For APPLESOFT™, Integer, or single machine language files, no programming knowledge is necessary. You will need experience if you want to save copy-protected or complex programs. The amount of experience necessary depends on the complexity of the program.

SYSTEM REQUIREMENTS

The quikLoader plugs into any slot of the][,][+, or //e. If installed in a][+, a slightly modified 16K card in slot 0 is suggested. A disk drive is required to save data.

\$179.50

DOS, Integer basic, FID, and COPYA are copyrighted programs of APPLE COMPUTER INC. licensed to SOUTHERN CALIFORNIA RESEARCH GROUP to distribute for use only in combination with quikLoader.

PROMGRAMER

designed by Bob Brice

software by Bob Sander-Cederlof

The PROMGRAMER™ will read or program any of the standard single voltage EPROMs, from the 2708 to the 27512. Features include:

- Slot independent operation for the APPLE // family of computers.
- Zero-insertion force sockets accepts 24 or 28 pin devices.
- Choice of standard or fast programming algorithms.
- Disk-based software allows easy customization of software
- Source code included.
- Complete instructions for loading PROMGRAMER software into quikLoader™.

\$149.50

EXTEND-A-SLOT

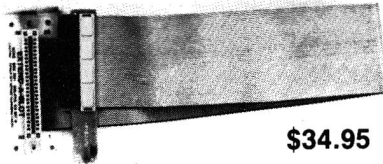

\$34.95

The EXTEND-A-SLOT brings a slot outside your APPLE™, allowing an easy change of cards. The 18" flex cable is long enough to allow placement of the card in a convenient location. The high quality connectors are gold plated for reliability.

EASY TO USE—just plug it in as you would any expansion card, then plug your card in. When you want to change cards, do it easily outside the computer, without the wear and tear on the computer expansion slot.

SWITCH-A-SLOT

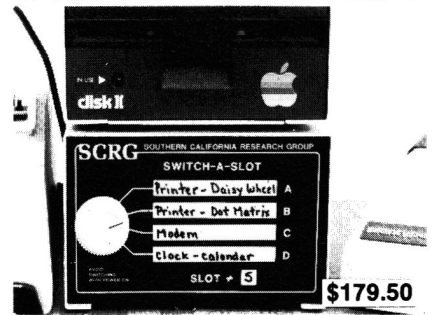

designed by Joy George

The SWITCH-A-SLOT is an expansion chassis, which allows the user to plug in up to four peripheral cards at one time. One of these cards is selected for use, and only that card draws power.

This product is especially useful where the software requires the printer to be in a particular slot, and the user wishes to choose between two or more printers.

- User selects desired card by front panel rotary switch.
- Plugs into any peripheral slot
- Saves wear and tear on delicate connectors.
- 18" cable connects SWITCH-A-SLOT to computer.
- Resistive terminations for better response.

SWITCH-A-SLOT and EXTEND-A-SLOT work well with most slow to medium speed cards, such as Modems, Printers, Clock, 80 Column, Music, etc. They are not recommended for high speed data transfer devices such as disk drive controllers, alternate processor, and memory cards. We cannot guarantee that these products will work with a particular system. We do have a money-back guarantee if it does not work for you.

Paddle-Adapple

GAME I/O ADAPTER AND EXTENDER

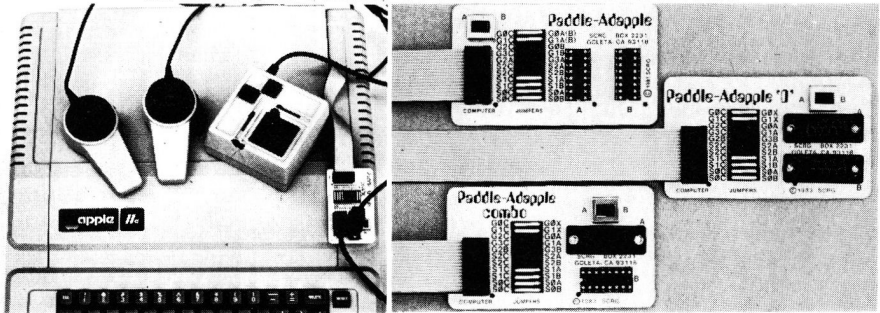

The PADDLE-ADAPPLE has two 16-pin sockets.

The PADDLE-ADAPPLE 'D' has two 'D' sub-miniature connectors.

The PADDLE-ADAPPLE COMBO has one 16-pin socket, and one sub-miniature connector.

- Works with all APPLE™ compatible joysticks, paddles, and most other I/O devices.
- Select one of two devices or...
- Use two joysticks simultaneously
- Suggested for One-on-One™, Archon™, etc.
- Unique "JUMPERS" socket allows you to configure to meet your needs.
- Plugs into internal 16-pin game I/O port.
- Small and compact. Adheres to computer with supplied foam tape.
- All strobes, annunciators and power available on all 16 pin sockets.
- Supplied with 18" cable. **\$29.95**

9-16 Adapter

For Apple //e and //c

This product permits the use of most 16 pin I/O devices with the APPLE //c or //e. By plugging this adapter into the sub-miniature 'D' connector, (in back of the computer), you can plug in a 16-pin device, such as the PADDLE-ADAPPLE, paddles, joystick, KOALA PAD™, etc. The only limitations are those devices that use the annunciators or the C040 strobe, such as the POWER PAD™. Please note that the //c does not support 2-joystick games.

\$14.95



16-9 Adapter

For Apple][+ or //e

This product permits the use of all 9-pin game I/O devices with the APPLE][+. By plugging this adapter into the internal 16-pin connector, you can plug in any 9-pin game device, such as paddles, joysticks, KOALA PAD™, Muppet Learning Keys™, etc. **\$14.95**

NEW PRODUCTS

SLOT 3 CLOCK

Designed by Chuck Sather for APPLE //e

- Fully supports PRODOS™, APPLESOFT™ compatible.
- Designed for slot 3 (usually otherwise unusable).
- Time and date-stamp files under PRODOS.
- Long-life lithium battery included.
- Installation software included. **\$79.50**

DUAL KEYBOARD ADAPTER

For Apple][and][+ only.

Allows the use of the built-in keyboard or external keyboard with no switching necessary. **\$39.50**

//c keypad

This kit will give you an "embedded" keypad within your built-in keyboard. You may instantly switch between the keypad or the standard keyboard. CAUTION - Requires dis-assembly of the computer, and expert de-soldering and soldering ability. **\$29.95**

OTHER PRODUCTS

D MANUAL CONTROLLER: Gives complete control over the SC000 through SC0FF range in hardware. Think of it as a hardware switch for soft switches. Can be switched while program is running. **\$89.50**

MAGIC KEYBOARD (for][or][+ only) Re-encodes the keyboard to give alternate keyboards, such as DVORAK, A.S.K., 10-KEY, HEXADECIMAL KEYPAD, etc. **\$49.50**

SIX MONTH WARRANTY TEN DAY RETURN PRIVILEGE TOLL-FREE ORDER LINES

in CA (800) 821-0774
(800) 635-8310

all other states (Including AK, HI, VI & PR)
Information & technical questions: (805) 529-2082

Available at your local dealer or direct from:
So. Calif Research Group
P.O. Box 593-R
Moorpark, CA 93021
(805) 529-2082
TELEX 658340 ATTN: SCRG
Answer Back INTERTEL SNC
VISA, MASTERCARD accepted

Add \$2.50 for shipping. Outside U.S. and Canada, \$5.00. For surface, \$10.00. Air, except Switch-A-Slot, \$25.00. Air.

GAME ROOM

by Brian J. Murphy

In Game Room, Brian Murphy reviews four to six of the most recent Apple games to hit the market. Look here for inCider's scoop on the latest fun.

Game Ratings

Bofo ★ ★ ★ ★

Cut above ★ ★ ★

Mundane ★ ★

Futile ★

Questprobe Featuring The Hulk

★ ★ ★

*Adventure International/
Scott Adams*

Box 3435
Longwood, FL 32750
Any Apple II, 48K,
one disk drive
\$29.95

Many pre-teen true believers, including myself, spent Saturday mornings watching the animated adventures of The Incredible Hulk. What was the big deal about the Hulk? Read on, soon-to-be true believer, and I'll tell you. He's an American legend.

Physicist Bruce Banner was the victim of one of his own experiments, and wound up being bathed in deadly gamma rays and metamorphosed into an 800-pound, green-skinned, dim-witted bruiser called the Hulk.

The Hulk is a misunderstood creature—always under attack by the Army and a gallery of super-criminals. There are the usual encounters with Marvel Comics' regular cast of superheroes and supervillains. He also endures kidnapping and other bizarre transformations—just the sort of situations the Hulk faces in his one and only computer game, **Questprobe Featuring The Hulk**, one of a 12-part series of Marvel adventures.

One of your main challenges is finding out the object of the game. The closest the documentation comes to a clue is a notation that the Hulk must unlock the riddle of the Chief Examiner and survive.

You begin the game the same way you'd expect a Hulk comic-book adventure to begin, with Dr. Banner tied up in a chair. Turning him into the Hulk is the first order of business. Emotional distress, especially rage, will trigger the metamorphosis from Banner to Hulk (**Photo 1**). Can you make Banner mad?

When you do get him out of the chair, you'll find that the Hulk is trapped in a world of mysterious domes. Some contain things like mirrors, broken chairs, and metal fans, but some of them contain gems. The trick is getting out of the dome you're in. There is a logical solution, and after a few tries (and reincarnations), you should be able to get in and out easily.



Photo 1. Watch David Banner turn into the Hulk.

The world outside the domes is hostile. You'll meet army ants who, despite your close ties with the hero Ant-Man, attack you at the slightest provocation. There's an underground room in which it's very easy to trap yourself—here Hulk gets a stiff dose of nerve gas. You'll find that a bar of wax is especially crucial to your success, but it's guarded by a swarm of killer bees that won't let you near it.

Those are the hazards you'll encounter in just the first 1 percent of the game. I slaved over this adventure for hours, and then, during a routine conversation with an Adventure International representative, told him about the progress I'd made.

"Is that all?" he replied. "You haven't even solved

one-hundredth, no, not even half a hundredth of this game."

Thanks for the compliment, I thought, but, on reflection, I saw he was right. I may have recovered a pile of gems and solved a few riddles, but I had yet to meet Adam Pym or the mysterious Ant-Man. Nor had I encountered the friendly Dr. Strange, the unfriendly Ultron, or the deadly Nightmare. I still had a good amount of screen animation to witness, as well.

So, despite the many hours of fun and thrills I've enjoyed playing Hulk's game, I haven't even scratched the surface. All in all, it's a good entertainment investment at \$29.95. There's action, surprise, strategy, and the opportunity to flex your mighty muscles and throw a few

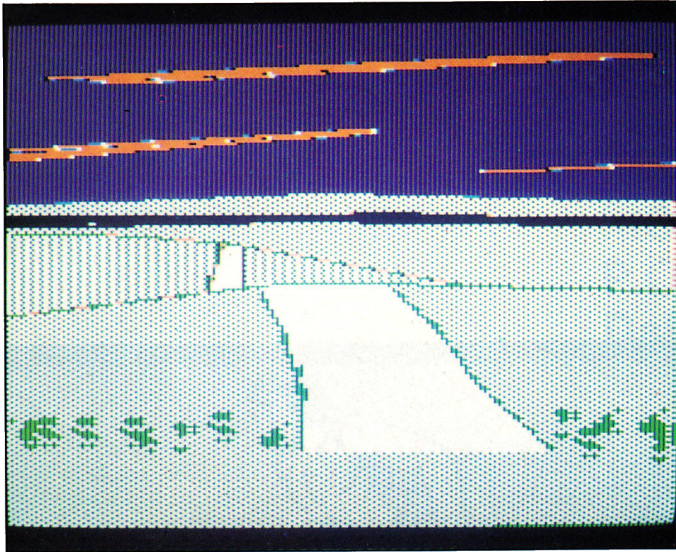

Photo 2. Follow the Ring Quest to adventure.

buildings around in the inimitable style of the Hulk. Based on the fun I've had and the fun yet to come, I recommend you take a look at the Hulk episode of Questprobe.

A note in passing: the version I looked at relied on a verb/object syntax for commands. It seemed appropriate, since the Hulk talks like that anyway ("Smash ants," "Get wax," and so on). The command syntax of the current edition, however, is up to current industry standards with a full-sentence interpreter.

The Hulk version of Questprobe is one of 12 Marvel Comics Questprobe adventures. We're hoping they will send us the Spider-Man game, along with any others we can get. Watch these pages for further developments, true believers.

Ring Quest

★ ★ ★

Penguin Software

830 4th Avenue
P.O. Box 311
Geneva, IL 60134
Any Apple II, 64K,
one disk drive
\$34.95

It's you and Gorn again,

matching wits with monsters galore in **Ring Quest**, a sequel to The Quest and another beautifully illustrated adventure game from Penguin (**Photo 2**). This time you're trying to rescue the beautiful sorceress Lisa, who has fallen under the influence of the evil Ring of Chaos. She's inside a castle surrounded by a forcefield maintained by three carefully hidden power sources. Your quest is to nullify those power sources and unite the Ring of Order, which you possess, with the Ring of Chaos.

Now for the tough stuff. The forest is full of ogres, trolls or manticoras guard the bridges, and a sorceress, perhaps Lisa herself, materializes from time to time to confuse you. To stay on the right track, you have to unravel complex puzzles and figure out why the game gives you certain details.

If you can make the connections in the following example, you'll have a clue to the solution. You encounter a white, crystalline rock in the forest. You're told that animal tracks surround the rock. Why? The bridge



Photo 3. Buying your armaments is a Calculated Risk!

over the chasm is guarded by the Manticora. The bones of animals it has eaten surround the beast. Can you make the connections here? If you can, you're on your way to the mindset needed to solve this adventure.

To make progress, you'll have to play some diabolically difficult arcade games. The first one I encountered took a good hour of solid effort to beat.

Ring Quest is an ideal game for a group session. And if you happen to know a fast gun from the arcade side of the game world, bring him or her along to help you out of a few jams. This is an adventure well worth your time, trouble, and cash.

Calculated Risk!

★ ★

Woodbury Software

Box 368
Morganville, NJ 07751
Any Apple II, 48K,
one disk drive
\$29.95

This game, designed for ages 7 and up, comes in a package that promises plenty of role-playing action and excitement. If you read

the last page of the manual closely, however, you'll see a more ominous description: "An exciting graphics adventure game that makes math fun!"

Can anyone make math fun? If you don't already think math is fun, then no game is likely to change your mind. For me, fun is fun and math is an entirely different thing. **Calculated Risk!** hasn't changed my mind.

You may know of dozens of math games and number puzzles that are enormously entertaining for the mathematically inclined. Calculated Risk! isn't that kind of game. It's an average adventure with uninspired mathematics drills tacked on almost as an afterthought.

As implausible as the premise of any adventure or fantasy/role-playing game may be, if the game carefully and consistently simulates the world it represents, then the player will

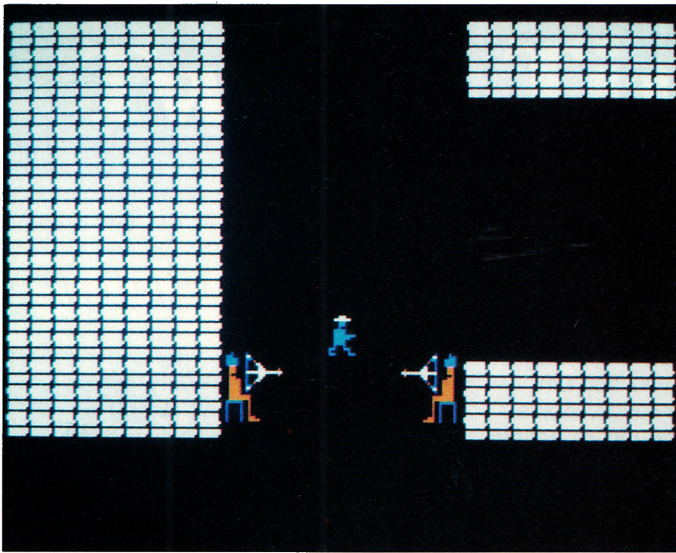

Photo 4. Only cunning and skill can get you out of the pyramid.

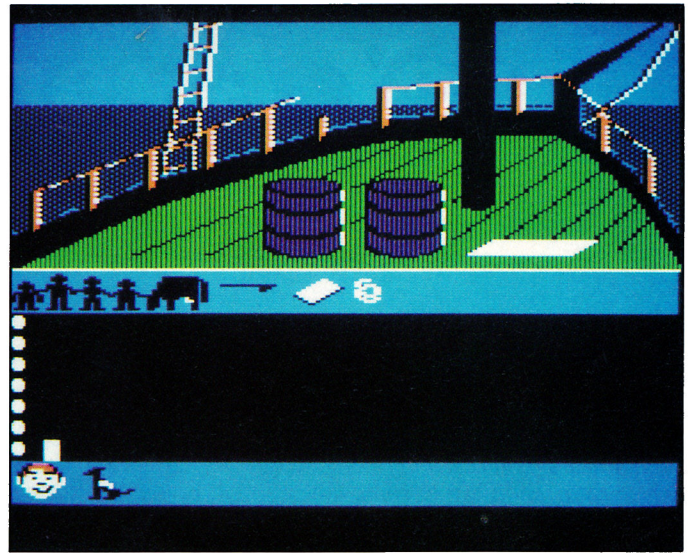

Photo 5. Salvage what you can from your shipwreck.

accept that world and find escape in playing the game. Good adventure gaming is pure escapism.

Having made that point, let's look at *Calculated Risk!* for a moment. The pyramid scenario is a Temple of Apschai type of maze, to describe it for all you role-playing veterans. When your character gets into trouble, he or she will fall into a trap, with escape depending on the answers to a series of math drill problems (Photo 3).

There goes the plausibility and the sense of escape. Picture, if you will, being caught in the mummy's lair and being handed a worksheet of third-grade arithmetic problems. Finish the worksheet and it's recess time; make a mistake and the mummy claws you to shreds. I gather the mummy only lets well-educated grave robbers rummage in his crypt.

Except for this jarring element of implausibility—which does not make math fun, no matter what it says on the package—this isn't such a bad game. In one

section, you negotiate with Arab merchants for various goods you'll need to explore the mysterious pyramid, and bargaining is fun (Photo 4). The uplifting element of mathematics intrudes here as you check the merchants' figuring of your bills. That application of math is at least plausible.

This Apschai-like game also contains a few surprises in the maze—monsters, a phoenix, mummies that grab you, and bandits who mug you. It's not outstanding role-playing, but it's reasonably entertaining.

Swiss Family Robinson

★ ★

Windham Classics/Spinnaker Software

One Kendall Square
Cambridge, MA 02139
Any Apple II
\$26.95

In its own special way, this is one of the toughest adventure games yet devised. As with all Windham games, the emphasis is on

nonviolence, as you peacefully solve a variety of survival problems facing your shipwrecked family.

The first order of business is getting the survivors off the boat and ferrying the supplies to shore (Photo 5). You need to build a raft—you have to locate tools, select materials from the debris on the ship, and lash the boards and debris together to make a reliable craft. This should take you only the rest of your life, unless you look at the documentation or press the HELP key for a hint.

Once you get your family on shore, your list of chores is endless. You must find or build shelter, find a source of drinking water, and locate a supply of food—without falling prey to the thousand-and-one hazards on the island.

The concept of this game is very strong. It places you in a realistic survival situation, one that

requires brains rather than force. Instead of shooting your way out of situations, you have to come up with an intelligent solution. This game pits mind over matter in an entertaining way.

Technically, this is an advanced adventure. The orders you give are complete sentences, and the on-screen graphics help you keep track of supplies and equipment. Younger players (the game is designed for ages 10 and up) should have no difficulty following the action. All in all, **Swiss Family Robinson** is a cute little game with a backbone of steel. It should certainly keep your interest as you try your hand at island survival. This game is especially good for kids and more than a little challenging for adults. ■

Brian Murphy is anxious to learn what you think of the present state of computer games. Write him at inCider magazine, 80 Pine Street, Peterborough, NH 03458.

HINTS/TECHNIQUES

Apple users know that there's always an easier way to get the job done. A shortcut here, an elegant twist there. That's what *Hints/Techniques* is all about. It's a technical information swap for readers who want to share their programming pointers, DOS tips, hardware secrets, and all those other insights that make you go "Aha!" in the night. So read on and see if you don't find just the solution you've been looking for.

Ditto

by David del Castillo

When you need multiple copies of a document and photocopies just won't do, you can turn to Apple Writer II's versatile Word Processing Language for a solution. Although Apple Writer itself includes no multiple-copy facility among its print functions, the WPL program presented here, Ditto, lets you print an unlimited number of copies of any text file—just follow the simple rules outlined below.

First, use the embedded printer-format commands available to you—see the Apple Writer II manual for a complete list.

Second, if you've included an embedded print command .TL or .BL (top line or bottom line) in your text file to suppress the printing of your header or footer on the first page, then the last line of the file should contain the embedded command .TL**** or .BL****. This erases the

TL or BL entry from the Print/Program Commands menu. If you don't include these new commands, Apple Writer will suppress the top or bottom line on the first page of the first copy of the file, but not on subsequent

copies. (If you want the header or footer to appear on every page, including the first, don't clear it as described above. In such cases, you should enter the TL or BL directly into the Print/Program Commands

Program Listing. The WPL program Ditto produces two or more copies of an Apple Writer II text file.

```

CATALOG   PGO      BEGIN
          O1
          PPR
          PGO      DOIT
          PND
          P THE NEXT LINE CLEARS THE SCREEN
          PPR ENTER AS CTRL/V CTRL/L CTRL/V
          PPR
          PPR
          PPR
          PPR      **** DITTO COPY PROGRAM ****
          PPR
          PIN      HOW MANY COPIES? =$C
          PSX $C
          DOIT   PIN   FILE NAME? (CAT = CATALOG) =$A
          PIN   DRIVE NUMBER =$B
          PAS   D =$D
          PAS $D$B =$D
          NY
          PCS      /$A/CAT/
          PGO      CATALOG
          PCS      /$A/cat/
          PGO      CATALOG
          PCS      /$A/Cat/
          PGO      CATALOG
          L $A,$D
          B
          E
          F##.FF#
          Y?
          LOOP   PNP
          PSX -1
          PGO LOOP
          PPR ENTER AS CTRL/V CTRL/L CTRL/V
          PPR
          PPR
          PPR *****
          PPR
          PPR      $C COPIES PRINTED
          PPR
          PPR *****
          PPR ENTER AS CTRL/V CTRL/G CTRL/G CTRL/G CTRL/G CTRL/G CTRL/V
          PIN   PRESS <RETURN> TO EXIT TO EDITOR
          NY
    
```

Figure. A text file prepared for use with the WPL program Ditto.

```
.tl*DITTO*-*March 15, 1985*
```

```
This is the first line of text to be printed.
This is the second line of text to be
printed.
```

```
.tl****
[ ]
```

Raise your Apple's IQ Twelve Times A Year!



Subscribe Now & Save \$12.00 off the Cover Price!

A one-year subscription to NIBBLE brings you twelve issues packed with programs and comprehensive articles to help you get the best out of your Apple.

You'll get over \$500 worth of programs for Home, Business, Education and Entertainment with complete instructions.

Nibble articles show what each program does, how to use it and enter it into your Apple, Franklin ACE or other Applesoft-compatible computer.

You'll enjoy regular features for the beginner as well as the expert. Among

these are the Educational Corner, where programs help make learning fun, Tips & Techniques which showcases little-known programming tricks, Utilities to facilitate Basic, DOS & Printing, and Games with arcade fun you can type and run.

Try a NIBBLE!

Here's what some of our Readers say:



- "Certainly the best magazine on the Apple!"
- "Programs remarkably easy to enter."
- "Your service is fantastic... as a matter of fact, I'm amazed!"

Apple® is a registered trademark of Apple Computer, Inc.
ACE® is a registered trademark of Franklin Computer, Inc.

Note
 Canada surface subscription rate is \$34.95
 Outside the U.S. and Canada surface subscription rate is \$39.95
 Domestic U.S. First Class subscription rate is \$51.95
 Canada Air Mail subscription rate is \$59.95
 Outside the U.S. and Canada Air Mail subscription rate is \$89.95
 All payments must be in U.S. funds drawn on a U.S. bank.

Join the more than 120,000 Apple/ACE users who say:

"NIBBLE is terrific!"

nibble  
 We accept Master Charge & Visa

45 Winthrop, St., Concord, MA 01742
 I'll try nibble!

Enclosed is my: \$26.95 (for 12 issues — U.S. Only)
 \$49.95 (for 24 issues — U.S. Only)
 \$69.95 (for 36 issues — U.S. Only)

(Outside U.S. see special note on this page)

check money order bill me (U.S. only)

Your subscription will begin with the next issue published after receipt of your check/money order.
 I use the following computers:
 Apple // Family Macintosh

Card # _____ Expires _____
PLEASE PRINT CLEARLY

Signature _____
 Name _____
 Address _____
 City _____
 State _____ Zip _____

menu before running Ditto.) See the accompanying **Figure** for an example of a properly prepared text file.

Third, make sure the final line in the text file is blank (no characters or spaces)—when you save the file, the cursor should be at the left margin below the last line containing either text or embedded commands. This allows Ditto to insert a form feed (.ff) at the end of the document before printing, and ensures that each copy will begin on a new page.

The pair of brackets ([]) at the end of the sample file designates the position of the cursor on the last line of the file (the line containing no characters or spaces). If the cursor is not there when you save the text, Ditto may not insert the form feed in the proper position, and only the first copy will definitely begin on a new page—others may not.

To enter the program, boot your Apple Writer II disk and type it in as shown in the **Program listing**, then save it as Ditto on the same disk.

To run the program, boot Apple Writer II and follow these steps:

- 1) Type control-P
Apple Writer will display [P]rint/
Program
- 2) Type DO DITTO and press the return key
- 3) Ditto then prompts you for the number of copies to be printed, the name of the file being printed (you may ask to see a catalog of your files by responding CAT), and the number of the disk drive containing the file.
- 4) The program then loads the selected file from disk and prints the desired number of copies. After each copy is printed, the program sends the printer a form feed that lets it begin the next copy on a new page. The bell on the computer beeps five times when the printer has finished.

If you have only one drive, you may eliminate the WPL line:

```
PIN DRIVE NUMBER = B$
```

and replace it with:

```
PAS 1 = B$.
```

If you want to use Ditto with single-sheet paper, you can make the printer pause between copies by deleting the program line LOOP PN and inserting two lines in its place: LOOP PIN (then roll in paper and press the return key) and PNP.

With WPL, you can expand Apple Writer's print functions and produce multiple original documents at the touch of a few keys. ■

Write to David del Castillo at 3204 Kylemore Road, Toledo, OH 43606.

Pseudorandom Numbers

by Ludwik Kowalski

Applesoft BASIC's random function (RND) doesn't always generate truly "random" numbers. The first time you use the function after turning on the computer (a cold boot), it always produces the same series of numbers. To generate other sequences after a cold boot, seeding is necessary.

I studied the effect seeds 1–30 had on the randomness of very long pseudorandom sequences. In particular, I tested how frequently the most-significant digits (0.0–0.9) of two consecutive randomly generated numbers occurred. For example, does the sequence 0.3, 0.7 occur as frequently as the sequence 0.5, 0.0?

Since only 100 combinations are possible, I sorted consecutive pairs of numbers into a 10-by-10 array. Then, using the chi-square statistic, goodness-of-fit probability test, I compared the distribution of sample frequencies with the numbers truly random sequences should generate. I considered any sequence with a degree of nonrandomness, DNR, outside the range of 0.7 to 1.3 to be nonrandom.

Short sequences of 1000 or 2000 pairs passed the randomness test for all the seeds I tried. On the other hand, with only one exception, all sequences longer than 40,000 pairs failed the test of randomness.

Nineteen proved to be the best seed and 11 the worst. The first time I ran the program using seed 19, the numbers were random like up to about 100,000 numbers (50,000 pairs). For seed 11, the numbers were random only up to 5600 numbers. Each additional time I ran the program using seed 19, numbers were random to a maximum of 40,000 numbers, while for seed 11 all consecutive sequences after the first were strongly nonrandom.

For any given seed, a degeneration of sequences into repetitive loops occurs—that is, after the program generates a certain number of numerals, N1, it repeats them in sequences of N2. Ten of the 30 seeds generated

sequences with short loops where N2 equaled 201. (The **Table** shows these seeds and their respective N1 values.) A single sequence one of these "bad" seeds generates can still be pseudorandom when its length is smaller than N1. After this, however, the degree of nonrandomness increases at a rate proportional to N1, so you should certainly avoid these bad seeds in situations that require long pseudorandom sequences.

You can use the remaining "good" seeds to generate sequences of up to 32,000 pseudorandom numbers (16,000 pairs), since the N2 values are either 32,365 or 37,757, with N1 values between 500 and 65,000.

Table. Bad seeds and their N1 values.

Seed	N1
4	22,990
5	37,000
10	29,300
11	5,560
15	36,220
18	12,069
22	10,810
23	21,940
25	17,110
30	19,210

The percentage of bad seeds does not seem to depend on the size of the seeds; it remains approximately 30 percent for all aimlessly selected sets of large seeds. Some other good seeds follow: 213; 1931; 4791; 26,921; 31,415; 71,351; 103,603; 395,622; 494,457; 715,234; and 927,563.

If you've noticed a certain "nonrandomness" in your programs that use the random-number generator, try using one of the "good" seeds mentioned here, or reseed your sequences from a table at intervals equal to N1/2. ■

Write to Ludwik Kowalski at the Department of Physics-Geoscience, Montclair State College, Upper Montclair, NJ 07043.

Got a hint of your own? inCider would like to see it. If we can use it in Hints/Techniques, we'll buy it from you. Send your tip to: inCider, 80 Pine Street, Peterborough, NH 03458.

They're talking a blue streak about Value Line's New Investment Software.

"VALUE/SCREEN is a fast fundamental analysis screening package that can save you hundreds of hours in screening and analysis time . . . It is a powerful and flexible program. . ."
PC MAGAZINE (July 10, 1984)

"I recommend this program to . . . anyone . . . who wants the ability to sift easily and rapidly through large amounts of monthly stock market statistical data."
FINANCIAL AND INVESTMENT SOFTWARE REVIEW (January/February 1984)

" . . . saves me 2 days work per week."
Business Consultant, McAllen, Texas

" . . . it makes perfect sense that Value Line should have sought to boil down its database into a package that could run on a personal computer. This is just the kind of information that makes VALUE/SCREEN particularly valuable. . ."
WALL STREET COMPUTER REVIEW (August/September 1984)

"It is so user-friendly. It is almost impossible to make an error."
Money Manager, Carlisle, Mass.

" . . . I found the program interesting and useful. . ."
COMPUTERIZED INVESTING (April, May 1984)



VALUE/SCREEN: The only investment software you'll ever need.
Stock Selection * Regular Data Disk Updates * Stock Reports *
Portfolio Management

Get VALUE/SCREEN Today!

I want VALUE/SCREEN!

- I'd like the \$39 trial offer, which includes complete documentation, program disk, and a current data disk — PLUS the next monthly updated data disk.
- I'd like an immediate 12-month subscription to VALUE/SCREEN with
 12 monthly data disks for \$348 or 4 quarterly data disks for \$211.

Tax deductible if used in managing your investments. Purchase is nonassignable. NY residents add sales tax.

Personal computer equipment:

- IBM Apple II series, 80-column display recommended.
- My check for \$ _____ is enclosed. Please bill my American Express MasterCard Visa

Account # _____ Exp. Date _____

Name _____ Signature _____

Address _____ City _____ State _____ ZIP _____

Value Line, Inc. 711 Third Avenue NY, NY 10017

Circle 197 on Reader Service Card.

ASK INCIDER

by Bob Ryan,
inCider Technical Editor

If you have a question, our technical editor has the answer. Send your queries about Apple computing to Bob Ryan, Ask inCider, 80 Pine Street, Peterborough, NH 03458.

Directed Reading

Dear *inCider*:

The ProCAT program (April 1985, p. 32) was an eye-opener. I have some ProDOS documentation, but I've never been able to find documentation for the file-processing commands that show the construct used to read the ProDOS directory. Can you give me some information on acceptable syntax for performing this function using the ProDOS OPEN, READ, WRITE, and CLOSE commands?

Marilyn Emerson
Box 1116
Cherry Hill, NJ 08034

Dear Marilyn:

Inside Apple's ProDOS, by John Campbell (Reston Publishing, Reston, VA), has an annotated listing on pages 34 and 35 that demonstrates how to read a ProDOS directory file from an Applesoft program. The trick is to specify the file type as TDIR when you open it. Your open statement should look like this:

```
50 PRINT CHR$(4);"OPEN";name of  
directory;"TDIR"
```

"Name of directory" is a literal string or a string variable that contains the name of the directory you want to read into memory. You then read from the file as you would any text file.

80-Column Escapism

Dear *inCider*:

An errata insert in my Apple 80-Column Text Card Manual states that the card does not support Applesoft's INPUT and GET commands. The manual recommends using the blinking underline-cursor routine on the Applesoft Sampler disk. I've used this routine and it works quite nicely, but it does have some limitations, especially in setting a horizontal window.

Some of my students have recently started programming in 80 columns and have used both INPUT and GET without any apparent problem. Have they just been lucky?

Howard Jackson
127 Southern Boulevard
Albany, NY 12209

Dear Howard:

Yes, your students have been lucky. They probably won't have any problems with INPUT and GET in 80-column mode, as long as no one hits the escape key in response to one of these statements. The 80-column card interprets the escape code as a flag for the beginning of a command sequence, and may do strange things if you enter escape via an INPUT or GET statement.

If you anticipate someone hitting the escape key in response to an INPUT or GET, you should stick with the routine you are using.

Moving Problems

Dear *inCider*:

I read your review of the Sider (the 10-megabyte hard disk from First Class Peripherals) and bought one—it really does work well. I transferred all my files to the Sider without any problem. Then I decided to save disk-access time and wear and tear by copying some of my Strategic Simulations games to the hard disk. I soon

learned that this isn't a very easy thing to do.

How can I get my copy-protected software onto the Sider? I've asked about "backing up" to a hard disk, but it seems that isn't possible with an Apple. I've even called Omega Microware (the publishers of Locksmith 5.0), only to find that Omega's technical-support personnel have no answer to my dilemma. Do you?

Paul Stromberg
3929 Fairway Drive
Wilmette, IL 60091

Dear Paul:

As long as software publishers insist on copy-protecting their products, you won't be able to transfer many of your programs from floppies to a hard disk. As the use of hard-disk drives on Apple machines becomes more common, you'll see many software manufacturers remove the copy protection from their products. Until then, you'll have to be content using the hard disk primarily for data storage.

MouseText for All

Dear *inCider*:

I own an Apple IIc, and would like to know how I can call up the mouse characters from Applesoft BASIC. I have a Beagle Bros "Peeks, Pokes, and Pointers" chart showing the mouse characters and their equivalents, but I still don't know how to access them. Can you help?

Jim Hughes
419 West Washington Boulevard
Grove City, PA 16127

Dear Jim:

Accessing the MouseText characters from Applesoft BASIC is simple. First, turn on the enhanced-video software by issuing a PR#3. Next, type in PRINT CHR\$(27) and the INVERSE

command. Now, whenever you print a capital letter or one of the special characters, the corresponding MouseText character will appear on your screen. To deactivate MouseText, type in PRINT CHR\$(24) and the NORMAL command.

Text Times Three

Dear *inCider*.

I recently added a communications package to my Apple IIe. I use it to transfer files between AppleWorks and a DEC PDP 11/60. I have no problem moving a text file from my Apple to the DEC machine; the difficulty arises when I want to download a text file from the PDP 11 to AppleWorks. Here is the procedure I follow:

- 1) PDP 11/60 text file to DOS 3.3 text file via Softerm 2 and modem
- 2) DOS 3.3 text file to ProDOS text file using ProDOS User's Disk
- 3) ProDOS text file into AppleWorks word-processing file

The system falls apart when I try to get AppleWorks to recognize the ProDOS text file as one AppleWorks can use. The file will be found by the "List all files on current disk" option, but not when I try to "Add file to the desktop." What is going on and how can I fix this situation?

Donald C. Williams
3441 Bryant Avenue South
Apartment #2
Minneapolis, MN 55408

Dear Donald:

AppleWorks files are not straight text files, so you can't just add text files to the desktop. To read a standard ProDOS text file into the AppleWorks word processor, you must do the following:

- 1) From the Main Menu, select option 1, "Add files to the Desktop."
- 2) From the Add Files menu, select option 3, "Word Processor."
- 3) From the Word Processor menu, select option 2, "From a text (ASCII) file."

inCider

AppleWorks then prompts you to type in the complete pathname of the ProDOS text file you want to load. After you enter the pathname, AppleWorks loads the file and asks you to type in the file name AppleWorks will access. Once you've named the file, it appears on your screen, and you can use it as you would any AppleWorks file.

Licensing DOS

Dear *inCider*.

Some time ago, I wrote to Apple Computer to inquire about licensing Apple DOS for commercial programs. I also wanted technical information about the IIe. I've never received an answer.

The letter from Bob Santoro in July's *Ask inCider* ("Developing Dilemma") prompted me to try again. Do you have an address to which I can write for information about licensing Apple programs? Should Apple prove unresponsive, what other sources of technical information are available?

Mike Matassa
14227 Rosetta Drive
Cypress, TX 77429

Dear Mike:

Send a letter of inquiry to Apple Computer, Developer Relations M/S 23-AF, 20525 Mariani Avenue, Cupertino, CA 95014. Currently, you can license DOS and ProDOS for \$50 each per year, per product.

One word of warning—I am writing this during a period of reorganization at Apple, and the information may change by the time this column sees print. If writing to Developer Relations doesn't pan out, try calling Apple's general switchboard (408-996-1010) for more up-to-date information.

By the way, you can order the IIe Technical Reference Manual and products from the Workbench series directly from your Apple dealer. ■

NASHUA DISKETTES

FIVE YEAR WARRANTY

75¢ each
Qty. 100

5 1/4" SS/DD or DS/DD, your choice, with hub ring and Tyvek sleeve, bulk packaged, no labels. Shipping extra. For quantity 50, add 10¢ each.

Get the same low price our high-volume duplication customers get!

**CALL TOLL FREE
1-800-321-4668**

in Colorado, 303-234-0871

ALF Products Inc. • Denver, CO

ACCELERATE PFS!

Our easy to use Speedup System **BOOSTS PFS 'FILE', REPORT, & GRAPH UP TO THREE TIMES FASTER.** Also **DOS 3.3, CP/M & PRODOS.**

**JUST PLUG IT IN & GO...
NOW UNDER \$300 !**

write or call today



26 W. Mission Street PO Box 2342
Santa Barbara, CA 93120 (805) 569-3132

Circle 67 on Reader Service Card.

The AT 2100 Local Area Network For APPLE II and APPLE IIe Computers with DOS 3.3

Features of the AT 2100

Collision avoidance transmission via multi-drop twisted pair.
Up to sixteen computers on the network.

Computer separation 2000 ft.

All software resident on board plug-in card.

No other software required.

With this menu driven system, you may:

- Send any type of DISK FILE to any computer on the network.
- Get any type of DISK FILE from any computer on the network.
- Read CATALOGS of any computer on the network.
- Type a MESSAGE to any computer screen on the network.
- User can protect any file from network access.

After any network operation, the receiving computer resumes as if no transmission had occurred.

PRICE \$299⁹⁵

For further information write or call:
ANALOG TECHNOLOGY, INC.

27 Fort Meadow Drive
Hudson, MA 01749
(617) 568-0215



Circle 104 on Reader Service Card.

PUBLIC DOMAIN SOFTWARE FOR THE APPLE

What is Public Domain Software? Public Domain Software (PDS) consists of programs that are donated to the public, and therefore, have no copyrights attached. They are written by a variety of people, some professionals, some not—in most cases each program is NOT commercial-quality and is not supported as such.

Who can use the Library? Our library is supplied in DOS 3.3, 16 sector format for Apple II computers. Please note that a few machine language programs will function erratically on the IIe and IIc because of changes in the F8 monitor. We have not tested all of the programs nor do we have a list of what works. So be careful—"Caveat Emptor."

What does the Computer Learning Center do? The Computer Learning Center provides a service that copies and DISTRIBUTES software in the public domain. Our library is constructed on a "per volume" basis, each volume containing approximately 20 programs. The \$4/volume fee covers the cost of the disk and costs involved in copying, labeling, packaging, mailing and other related expenses. Due to the nature of our library, PDS cannot be returned for a cash refund or exchanged for additional volumes.

When using our PDS listings, the volume name and number is in bold print. Use the volume number next to the name when you order. Each volume name is followed by a list of programs on that disk. (Except Eamon, where only the scenario title is listed.) The left column of this list indicates the language required by the program. (A—Applesoft, I—Integer, B—Machine Code, and T—Text Files.)

What is an Eamon Adventure? Eamon Adventures are a collection of entertaining, flexible, fantasy role-playing, **text-adventures** in the public domain.

MASTER/Beginner's Cave. The Master Diskette is **required** to play EAMON. It is used to create your character and stores the character data between adventures. This volume also contains the Beginner's Cave—a short (but not entirely safe) romp for your new character. (Highly recommended training for new adventurers.)

How to Order:

1. Select the volumes with the programs that you want.
2. Check the numbered boxes on this form that match your selections.
3. For every 10 volumes that you order, you get 1 free bonus volume. Circle your FREE bonus selection on the order form.
4. Fill in the address information. (Please print neatly.)
5. Total the number of volumes that you are ordering and multiply this number by \$4.00. The minimum order is two (2) volumes.

* Washington residents add 7.8% sales tax.

* Overseas, Canada, and Mexico: add 20% for shipping.

6. Send a check or money order for the total amount due. We accept VISA/MC. Credit card orders must have a valid signature. We accept international money orders (in USA funds) and checks drawn on USA banks. Canadian checks must specify USA dollars. Make them payable to:

Computer Learning Center P.O. Box 110876-J Tacoma, WA 98411

E01 E02 E03 E04 E05 E06 E07 E08 E09 E10
 E11 E12 E13 E14 E15 E16 E17 E18 E19 E20
 E21 E22 E23 E24 E25 E26 E27 E28 E29 E30
 E31 E32 E33 E34 E35 E36 E37 E38 E39 E40
 E41 E42 E43 E44 E45 E46 E47 E48 E49 E50
 E51 E52 E53 E54 E55 E56 E57 E58 E59 E60
 E61 E62 E63 E64 E65 E66 E67 E68 E69 E70
 E71 E72 E73 E74 E75 E76 E77 E78 E79 E80
 E81 E82 E83 E84

P01 P02 P11 P18 P19 P20 P21 P36 P50 P59
 P61 P67 P71 P76

Send me the volumes that I have checked. I understand that the minimum order is two volumes.

Name _____

Address _____

City _____ State _____ Zip _____

Country _____ Phone _____

VISA/MC# _____ Exp _____

Signature _____

Public Domain Software is supplied as-is. J

EAMON Adventures

E1 MASTER/Beginner's Cave
 E2 Lair of the Minotaur
 E3 Cave of the Mind
 E4 Zythur River Venture
 E5 Castle of Doom
 E6 Death Star
 E7 Devil's Tomb
 E8 Abductor's Quarters
 E9 Assault of the Clone Master
 E10 Magic Kingdom
 E11 Tomb of Molinar
 E12 Quest for Trezore
 E13 Caves of Treasure Island
 E14 Furioso
 E15 The Heroes' Castle
 E16 Caves of Mondamen
 E17 Merlin's Castle
 E18 Hogarth Castle
 E19 Death Trap
 E20 The Black Death
 E21 Quest for Marron
 E22 Senators' Chambers
 E23 Temple of Ngurct
 E24 Black Mountain
 E25 Nuclear Nightmare
 E26 Assault on the Moleman
 E27 Revenge of the Moleman
 E28 Tower of London
 E29 Lost Island of Apple
 E30 Underground City
 E31 Gauntlet
 E32 House of Ill Repute (Adult)
 E33 Orb of Polaris
 E34 Death's Gateway
 E35 Lair of the Mutants
 E36 Citadel of Blood
 E37 Quest for the Holy Grail
 E38 City in the Clouds
 E39 Museum of Unnatural History
 E40 Deamons Playground
 E41 Caverns of Lanst
 E42 Alternate Beginner's Cave
 E43 Tomb of Y'Golonac
 E44 Operation Crab Key
 E45 Feast of Carroll
 E46 The Master's Dungeon
 E47 Crystal Mountain
 E48 Lost Adventure
 E49 The Manxome Foe
 E50 Behind the Sealed Door
 E51 Land of Death
 E52 Jungles of Vietnam
 E53 Black Castle of Nagog
 E54 Sewers of Chicago
 E55 Caverns of Doom
 E56 Valkenburg Castle
 E57 Modern Problems
 E58 Priests of Xim
 E59 Escape from the Orc Lair
 E60 Castle of Count Fuey
 E61 Search for the Key
 E62 The Rescue Mission
 E63 The Maze of Quasequeton
 E64 Chamber of the Dragons
 E65 Swordquest
 E66 Smith's Stronghold
 E67 Picnic in Paradise
 E68 The Caves of Eamon Bluff
 E69 Future Quest
 E70 Castle Kophinos
 E71 The Devils Dungeon

E72 Harpy Cloud
 E73 The School of Death
 E74 The Dungeons of Xenon
 E75 Chaosium Caves
 E76 Life Quest
 E77 Dharmaquest
 E78 Mean Streets
 E79 The Temple of the Guild
 E80 Deep Canyon
 E81 The Castle of Rauneta
 E82 The Prince's Tavern
 E83 The Search for Yourself
 E84 The Temple of the Trolls

P01 Apple Tutor

I 036 Basic Programming 1
 I 047 Basic Programming 2
 I 048 Basic Programming 3
 I 044 Basic Programming 4
 A 004 Basic-Integer
 B 022 Basic-Integer.X
 I 019 Conventions
 I 016 CPU 6502
 I 002 Hello Sample
 I 030 Micro 6502 Simulation
 I 051 Mini Assembler Tutorial
 A 022 Random Drill Tutor
 I 007 Sweet 16 Disassembler
 I 004 Sweet 16 Speed ?
 I 026 Top Down Programming

P02 Apple Tutor

A 021 Apple II Demo
 A 004 Basic Exercise
 I 043 Basic-Applesoft
 I 093 Disk Aide.13
 I 038 Disk Aide DOC
 B 003 Disk Aide.X
 A 028 DOS System Instruction
 A 013 Pilot Version I
 I 054 Program Development Pkg
 A 014 Supplement Mini Assembler
 B 006 Supplement.X
 I 003 Text File Read
 I 003 Text File Write
 I 009 Text Hello
 T 009 Text How To
 T 010 Text Intro
 T 006 Text Peek Poke Call
 T 010 Text Programming
 T 007 Text Redbook
 T 011 Text Software
 A 002 Buzz

P11 Art & Graphic

A 006 Art Align
 A 002 Art Bars
 A 003 Art Circle
 A 002 Art Demo
 A 003 Art Diverging Circles
 A 003 Art Diverging Octagons
 A 003 Art Double Cross
 A 006 Art Dougs Theme
 A 003 Art Drifting Circle
 A 003 Art Drifting Octagon
 A 004 Art Elephant
 A 003 Art Figure 8
 A 005 Art Horizon
 A 007 Art IBM
 A 003 Art Octal 8
 A 002 Art Oneliner 7
 A 007 Art Super Kalied
 A 003 Art Twist II

Apple II, II+, IIe and IIc are trademarks of Apple Computer, Inc.

A 015 Art Xmas Card
A 014 Auto Space War II
A 002 Billboard Mother
A 002 Graphic Switch
A 010 Graphics Tablet
A 008 Hi-res Text Demo ?
B 007 Hi-res Text Set
A 004 Higher Hires
A 006 Hires Sketch
A 003 Invert Monitor Mode
A 035 Life
B 015 Life Language
A 004 Life Leader
A 002 Picture Loader
A 016 Plot Pourri
A 010 Poster ?
A 008 Poster Banner I
A 009 Poster Love II
A 003 Rubber Apple
A 020 Shape Editor
A 010 Shape Generator
A 003 Shape Instr
A 023 Shape Table Editor
T 001 Shape Table for Hires Label
T 002 Shape Test
A 015 Skywriter
A 003 Skywriter I
A 003 Skywriter II
A 025 Skywriter Instr
A 013 Skywriter Snoopy
B 018 Star.shape
A 005 TV Pattern Generator

P18 Business & Finance

A 005 Annuity Principal & Int.
A 003 Annuity Reg. Deposits
A 018 Annuity ◀
A 013 Bond Price & Interest
A 012 Bond Value
A 032 Budget Monthly
A 013 Decision Matrix
A 054 Financial Pak
A 016 Invest. Annuity Forecast
A 012 Keogh Savings Program
A 014 Loan Amort. Schedule
A 008 Loan Direct Reduction
A 004 Loan Interest
A 029 Market Evaluator Pak
A 009 Mortgage Calculation
A 007 Nicer Writer ◀
A 003 Regular Deposits I
A 007 Sales Tax At 6%
A 017 Security Analysis
A 006 Sec. Analysis Copy Data
A 003 Simple Interest
A 010 Stock Option Analysis
A 016 Stock Op covered hedge
A 015 Stock Option Pricing I
A 021 Stock Option Pricing II
A 008 Stock Portfolio Valuation
A 028 Stocks
A 010 Trip Cost Analysis

P19 Business & Finance

I 030 Calendar Personal
I 006 Letter Writer
I 006 Letter Writer Enhance
I 014 Phone List
I 005 Real Estate Plot
B 034 Real Estate Plot.X
A 012 Stock Monitor I
A 015 Stock Monitor II
A 024 Trend Line Analysis
A 006 Visicalc Coord Formulas
A 012 Visicalc D File Printer
A 014 Visicalc Formulas
A 006 Visicalc Formulas Instr

P20 Business & Finance

A 025 Apartment Mortgage
A 052 Banking And Finance
A 058 Business Finance
A 006 Check Stub
A 020 Household Exp. Profile
A 041 Income Tax 1040 For 77
A 029 Inventory Company
A 004 Inventory Cost File Entry
A 016 Inventory Home I
A 022 Inventory Model
A 009 Inventory Print ◀
A 003 Inventory Shortest
A 003 Inventory Shortest Read
A 023 Inventory
A 003 Inventory.DOC
A 019 Inventory.File Create
A 029 Inventory.File Read
A 018 Stock Market Forecaster
A 011 Stock Valuation

P21 Business & Finance

A 004 Annuity
A 004 Average Growth Rate
T 001 Basenamefile
A 046 CAC Record System ◀
A 009 Check Book Balancer
A 008 Check Writer
A 004 Depreciation Amount
A 003 Depreciation Rate
A 010 Depreciation Schedules
A 003 Depreciation Straight
A 004 Disc. Commercial Paper
A 024 House Sales
A 005 Income Taxes
A 012 Interest Earned
A 003 Interest Rate
A 038 Inventory Home II
A 004 Invest. For Withdrawals
A 004 Investment Future Value
A 004 Investment Initial
A 013 Lease Computation
A 031 Life Mgmt And Finances
A 012 Life Mgmt Txt Organizer
A 005 Loan Balance
A 007 Loan Interest Rate
A 005 Loan Last Payment
A 004 Loan Principal
A 005 Loan Regular Payment
A 004 Loan Term
A 004 Mortgage Computer
A 007 Mortgage Table
A 063 Payroll
A 004 Regular Deposits II
A 003 Regular Withdrawals
A 004 Salvage Value
A 009 Savings Growth
A 011 Survey Data Reduction
A 003 System Reliability
A 004 Treasury Bill Valuation

P36 Game

A 027 Blackjack Strategy
A 012 Combat
A 017 Craps BW
A 035 Cribbage I BW
A 028 Football Predictions
A 011 Fox And Hounds
A 026 French Military Game
A 020 Gold Mine
A 022 Golf II
A 016 Hi Q
A 027 Hockey I
A 021 Horse Race III
A 031 Kingdom
A 008 Literature Quiz

A 026 Marooned In Space
A 004 Ping Pong
A 010 Robot BW
A 016 Survive
A 018 Twonky I
A 018 Word Maze Maker
A 003 Football Predictions.note

P50 Game

A 017 Battle
A 015 Century 51
B 002 Century 51.X
A 020 Checkers II
A 021 Commodity Market
A 016 Craps I
A 013 Cryptograms
A 017 Frustration
A 027 Geography II
A 015 Hangman II
A 022 Lunar Landing BW
A 061 Market Crash
B 005 Market Crash.X
A 009 Name the States
A 018 Puzzle Generator
A 007 Solitaire Checker Puzzle
A 010 Spell the States
A 012 Subscan for Two
B 002 Subscan.X
A 031 World War

P59 Math & Statistics

A 008 Anglo To Metric I
A 011 Anglo To Metric II
A 003 Arcsin Arccos
A 016 Calculator
A 007 Calculus I
A 013 Calculus II
A 007 Cash Register
A 005 Circle Area Circum
A 009 Compound Interest
A 010 Critical Path Analysis
A 006 Curve Fit I
A 013 Curve Fit II
A 013 Curve Fit III
A 003 Derivative of Equation
A 010 Differential Eqn Solver
A 015 Equation Solver
A 005 Equations I
A 014 Equations II
A 014 Factor
A 003 Fibonacci Numbers
A 012 Foot Candle Analysis
A 010 Fourier
A 011 Fourier Transform
A 007 Gaussian Quadrature II
A 010 Math Drill I
A 011 Math Drill II
A 005 Matrix Inversion II
A 009 Matrix Operation
A 016 Mean Vari Strd Devia II
A 007 Mode Finder
A 003 N Factorial
A 007 Plot Consecutive Reactions
A 006 Plot Functions of X
A 003 Prog Chart ?
A 011 Robot Motor Design
A 005 Sine Function
A 010 Statistics I
A 014 Statistics II
A 014 T Test Stdn Deviation
A 004 Time Speed Dist. Exer.
A 006 Time Speed Dist. Fuel
A 014 Triangle Solver
A 011 Unpaired Group Comp.

P61 Math & Statistics

A 003 Angle Conversion

A 012 Anglo To Metric III
A 003 Area of Polygon
A 008 Binomial Distribution
A 004 Blackbody
A 003 Chi Square Distribution
A 004 Chi Square Test
A 004 Coordinate Conversion
A 008 Coordinate Plot
A 003 Curvilinear Interpolation
A 002 Derivative
A 016 Dfit
A 011 Differential Eqn Solver
A 004 Exponential Regression
A 004 F Distribution
A 004 Gaussian Quadrature I
A 003 Geometric Mean
A 004 Geometric Regression
A 004 Greatest Comn Denom.
A 005 Histogram
A 003 Linear Interpolation
A 007 Linear Programming
A 004 Linear Regression
A 005 Mann Whitney U Test
A 022 Math Drill III

A 019 Math Multiply Drill
A 019 Math ◀
A 013 Matrices
A 004 Matrix Inversion I
A 004 Matrix Multiplication
A 004 Matrix Operation Simple
A 004 Mean Vari Strd Devia I
A 007 Mult. Linear Regression
A 004 Normal Distribution
A 006 Nth Order Regression
A 004 Number Combinations
A 002 Parabola Plot
A 003 Permutation Comb. I
A 007 Permutation Comb. II
A 003 Poisson Distribution
A 006 Polar Equation Plot
A 011 Polyfit
A 013 Polynomial Regression
A 006 Power Curve Fit ©
A 003 Prime Factors I
A 006 Prime Factors II
A 003 Quadratic Formula
A 006 Quadratic Surface
A 015 Right Triangle Solver
A 016 Root Finder
A 005 Roots of Poly Half
A 005 Roots of Polynomials
A 004 Simpson's Rule
A 004 Simultaneous Equations
A 004 T Distribution
A 005 T Distribution Test
A 003 Trapezoidal Rule
A 005 Triangle Factors
A 007 Triangle Parts
A 003 Trig Polynomial
A 004 Vector Analysis
A 003 Vector Operations

P67 Passion (Adult)

A 002 Form 0 Startup
B 034 Form 1
B 034 Form 2
B 034 Form 3
B 034 Form 4
B 034 Form 5
B 034 Form 6
B 034 Form 7
B 034 Form 8
B 034 Form 9
A 005 Hot Apples I
A 006 Hot Apples II
A 013 Touch I
A 013 Touch II

I 013 Zoom 1
I 013 Zoom 2

P71 Pastime & Other

A 048 Bio-Rhythms
A 011 Calendar One Month
A 007 Calendar Perpetual
A 020 Calendar Reminder
I 020 Colossus
A 011 Decision Maker III
I 063 Dirty Tricks Beware
A 025 Dirty Tricks II
B 018 Dirty Tricks.X
I 020 Horoscope
A 026 Miles Per Gallon Record
I 074 Numerology
I 002 Phone Mnemonic 1
B 003 Phone Mnemonic 1.X
A 010 Probability
A 014 Random Insults
I 002 Random Words 1
I 003 Syn Tax
I 008 Timer

P76 Utility

A 003 Base Conversion Chart I
A 003 Base Conversion Chart II
A 006 Base Convert **
A 005 Base Convert Beymer
A 012 Base Convert Ellmers
A 005 Base Convert Jenkins
A 029 Base Convert Massimo
I 043 Basic-Applesoft
A 007 Binary To FP
A 053 Calendar And Posters
A 002 Capture A Program
A 005 Catalog Printer
A 003 Clear Memory
A 004 Copy Text File I
A 004 Copy Text File II
A 004 Copy Text File III
A 004 Ctrl Char Catalog
A 003 Ctrl Char Reveal
A 003 Dump ASCII Memory
A 002 Erase Hires Screen
A 011 Format #
A 003 Free Sectors Aldrich
A 004 Free Sectors Brown
B 002 Free Sectors Brown.X
A 019 Illegal Commands
A 005 List Page Diaz
A 005 List Page Wysocki
B 002 List Page Wysocki.X
B 002 List Page.X
A 007 Mach To Pokes Conv
A 002 Musical Keys
B 002 Musical Keys.X
A 013 Phone Dialer
A 003 Pointers
A 002 PR# 6 On Reset
A 003 Random Sentence
B 002 Rem Stripper
A 003 Rem Stripper Doc
A 006 Renumber
A 004 Renumber Merge
A 003 Reverse Print
A 018 Sort Catalog
A 015 SSM AIO Board
A 004 String Comparator
A 004 String In A String Search
A 004 Text File Edit
A 003 Text File Peek
A 003 Text File Read & Print I
A 005 Text File Read & Print II
A 005 Text File Write
A 004 Token Address Table I
A 005 Utility Statements

by Matthew Lesko

A COLLECTION OF FREE OR INEXPENSIVE DATA BASES AND MONEY-SAVING TIPS FOR GOING ON-LINE.

► **Paint the Town Red**

Planning to visit Los Angeles? Dial BY-PHONE for the latest information about restaurants, movies, plays, and automobiles in the LA area. For your dining pleasure and convenience, the restaurant section is listed by nationality and menu prices. The service also includes a personal-ads section. Use your modem to call (213) 474-0270.

► **On-line Reading**

For all the news that's fit to put on-line, read *Modem Times*. A yearly subscription to the on-line magazine costs \$20, but three-month subscriptions cost just \$6. You can get a free 30-minute look at the system by using your modem to call (303) 578-5405.

Editorial content features articles, columns, letters to the editor, games, contests, and movie, book, and restaurant reviews. *Modem Times* solicits articles from its users. For more information, write to *Modem Times* at 15 North 14th Street, Colorado Springs, CO 80904.

► **On Capitol Hill**

The politically minded in Massachusetts have access to a free data base that keeps them up to date on White House, state, and local government news. The service is also stocked with information ranging from Boston-area weather reports to employment listings to entertainment schedules.

The system highlights its classified- and retail-ad section. A five-line classified ad costs \$6 per month; a six-line retail ad costs \$30 per month. The modem number is (617) 489-4930. For details, write or call Yellowdata at 490 Trapelo Road, Belmont, MA 02178, (617) 484-6814.

► **The Ultimate BBS**

Take a look at a bulletin-board system that claims to be on the leading edge of BBS technology. Pro-Net is operated by experts in Apple, IBM, Tandy, and Commodore systems. A yearly subscription to this innovative bulletin board costs \$25, but you can get a free tour by using your modem to call (416) 683-3733 or (416) 445-6696. For more information, contact Toronto Pro-Net, P.O. Box Station A, Willowdale, Ontario M2N 5S7, Canada.

► **Bye-Bye Monthly Minimum**

Time was when SDC Information Services billed you a \$100 monthly minimum if you used any of the data bases in its Orbit system. Well, no longer. Starting charges still cost at least \$125, plus fees ranging from \$60 to \$165 per connect hour and 20 cents to \$1 per printed citation, but there is no minimum-usage charge. For more information contact SDC Information Services, 2500 Colorado Avenue, Santa Monica, CA 90406, (800) 421-7229, or (800) 253-6689 in California.

► **300 Will Get You 1200**

Follow this procedure if you know your 300-baud number for Telenet, but are looking for your 1200-baud number: Call your 300-baud number, type "MAIL" at the @ sign, type "PHONES" for the user name, then "PHONES" for the password. This gives you the complete list of 300- and 1200-baud telephone numbers for all cities served by Telenet. Best of all, you don't have to wait for the entire list; you can access the system by state or area code. You can also call customer service. Voice numbers are (800) 336-0437 and (703) 689-6400.

► **It's Academic**

This fall, the National Information Utilities Company and the Maryland State Department of Education will introduce a data-base service aimed at schools. Using broadcast-band waves, the system features courseware, electronic mail, news services, journals, and special graphics for scientific experiments.

The system should also suit business applications, because it's more economical to use broadcast waves instead of telephone lines. For details contact Paul Geffert, National Information Utilities, 8150 Leesburg Pike, Vienna, VA 22180, (703) 734-7000.

Editor's note: If you can't connect with one of these data bases, it may be temporarily—or permanently—off the air. Many data bases are noncommercial ventures and can encounter financial difficulties. Feel free to contact Matthew Lesko if you continue to run into obstacles. ■

Matthew Lesko is the founder and president of Information USA, Inc., a computer data-base consulting and publishing company. He is the author of seven information books—two of which made the New York Times best-seller list. For a free copy of his newsletter on computer data bases, write to Information USA, Inc., 4701 Willard Avenue, #1707, Chevy Chase, MD 20815, or call (301) 657-1200.

inCider

inCider magazine is published monthly by CW Communications/Peterborough, Inc. Entire contents copyright 1985 CW Communications/Peterborough, Inc. No part of this publication may be reprinted, or reproduced by any means, without prior written permission from the publisher. All programs are published for personal use only. All rights reserved.

inCider is a member of the CW Communications/ Inc. group, the world's largest publisher of computer-related information. The group publishes 53 computer publications in 24 major countries. Nine million people read one or more of the group's publications each month. Members of the group include: Argentina's *Computerworld/Argentina*; Asia's *The Asian Computerworld*; Australia's *Computerworld Australia*, *Australian Micro Computerworld*, *Australian PC World*, and *Director's*; Brazil's *DataNews* and *MicroMundo*; China's *China Computerworld*; Denmark's *Computerworld/Danmark* and *MicroVerden*; Finland's *Mikro*; France's *Le Monde Informatique*, *Golden (Apple)*, and *OPC (IBM)*; Germany's *Computerwoche*, *Microcomputerwelt*, *PC Welt*, *Software Markt*, *CW Edition/Seminar*, *Computer Business*, and *Commodore Magazine*; Italy's *Computerworld Italia*; Japan's *Computerworld Japan* and *Perso ComWorld*; Mexico's *Computerworld/Mexico* and *CompuMundo*; Netherland's *CW Benelux* and *Micro/Info*; Norway's *Computerworld Norge* and *MikroData*; Saudi Arabia's *Saudi Computerworld*; Spain's *Computerworld/Espana* and *MicroSistemas*; Sweden's *ComputerSweden*, *MikroDatorn*, *Min Hemdator*, and *Svenska PC World*; the UK's *Computer Management* and *Computer Business Europe*; the U.S.' *Computerworld*, *HOT CoCo*, *inCider*, *InfoWorld*, *MacWorld*, *Micro Marketworld*, *PC World*, *RUN*, *73 Magazine*, and *80 Micro*.

Problems with Advertisers: Send a description of the problem and your current address to *inCider*, Route 101 and Elm Street, Peterborough, NH 03458, attn. Rita Rivard, Customer Service Manager. If urgent, call (800) 441-4403.

Problems with Subscriptions: Send a description of the problem and your current and/or most recent address to: *inCider*, Subscription Department, P.O. Box 911, Farmingdale, NY 11737. Or call (800) 645-9559, (800) 732-9119 in New York, between 9 a.m. and 5 p.m. E.S.T., Monday through Friday. If you have a problem with payment, please have your mailing label and your cancelled check or credit card statement in front of you.

Change of Address: Send an old label or a copy of your old address and new address to: *inCider*, P.O. Box 911, Farmingdale, NY 11737. Please give eight weeks' advance notice.

Microfilm: This publication is available in microform from University Microfilms International. United States address: 300 North Zeeb Road, Dept. P.R., Ann Arbor, MI 48106. Foreign address: 18 Bedford Row, Dept. P.R., London, WC1R4EJ, England.

Dealers: Contact Raino Wirein, Direct and Newsstand Sales Manager, *inCider*, Route 101 and Elm Street, Peterborough, NH 03458. Call (800) 343-0728.

Back Issues: Send \$3.50, plus \$1.00 postage for each copy to *inCider*, Back Issues Dept., Route 101 and Elm Street, Peterborough, NH 03458. For ten or more copies postage is a blanket \$7.50. To order by telephone using VISA, MasterCard or American Express call (800) 258-5473 from outside New Hampshire, or 924-9471, ext. 136, within New Hampshire.

Submissions: We're always looking for first-class manuscripts at *inCider*. We'll consider publication of any material for the Apple. Guidelines for budding authors are available—just address an envelope to yourself and include it with your request. Mail manuscripts, queries, or requests for writers' guides to: *inCider* Editorial Offices, 80 Pine Street, Peterborough, NH 03458.

Yes! . . . TeamMate's Apple IIe Subsystems Now Support ProDOS, DOS 3.3, CPM and PASCAL!

Special
Introductory
Offer!

Now your Apple IIe can have the best storage system available, no matter what operating system you use. In fact, you can now run a combination of operating systems on a single TeamMate subsystem!

And, you can replace up to 19 Apple floppies with one diskette.

Your Apple IIe can have high capacity data storage like a Winchester while you enjoy the convenience and familiarity of a standard floppy . . . regardless of your operating system.

TeamMate's flexible disk drive from **Eastman Kodak** gives you 2.78 megabytes of data storage on one diskette. You get expandable storage and access to Winchester capabilities . . . **at a very low cost.**

TM 2203 . . . A single Kodak flexible disk drive giving you 2.78MB on one diskette.

TM 2206 . . . Two Kodak drives for a total of 5.56MB of online, expandable storage.

TM 2210 . . . 10MB of Winchester storage, with the option of later adding a Kodak flexible drive.

TM 2213 . . . A 10MB Winchester combined with the Kodak 2.78MB flexible drive for built-in back-up.

TM 2232 . . . 32MB of Winchester storage—the ultimate in high performance mass storage.

Now . . . for a limited time . . . you may purchase any quantity of TeamMate's subsystems at our **special Quantity 3-9 discount price!**

TeamMate Model	Quantity 1-2	Quantity 3-9
TM 2203	\$ 895	\$ 761
TM 2206	\$1295	\$1101
TM 2210	\$1295	\$1101
TM 2213	\$1695	\$1441
TM 2232	\$2195	\$1866
Kodak Diskettes	\$ 15	\$ 14

Ask about our quantity discounts.

All TeamMate subsystems include drive(s), controller, TeamMate chassis, power supply, necessary cabling, and manual. Kodak subsystems include a Kodak diskette.



Price includes UPS surface shipping.
Allow 3-4 weeks delivery.

Team-Mate

Yes, I want to expand data storage on my Apple IIe. Please send me the following:

Quantity:

_____ TeamMate 2203 @ _____ ea.
 _____ TeamMate 2206 @ _____ ea.
 _____ TeamMate 2210 @ _____ ea.
 _____ TeamMate 2213 @ _____ ea.
 _____ TeamMate 2232 @ _____ ea.
 _____ Kodak diskettes @ _____ ea.

Subtotal _____

CA & MA residents, add sales tax _____

For optional UPS Blue Label delivery add \$10 per unit _____

Total Enclosed \$ _____

Ship To:

Name _____

Address _____

City _____

State _____ Zip _____

Daytime Phone _____

Payment Enclosed:
 check money order
 cashier's check

Make check payable to:
 Data Technology Corporation
 Dept. TM-1A
 2525 Walsh Avenue
 Santa Clara, CA 95051

For fastest delivery, call:
 In California, call collect:
 408-986-9545

1-800-824-3724

THE STATISTICS SERIES

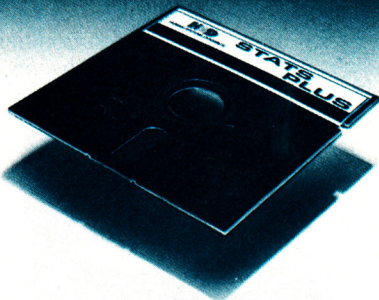
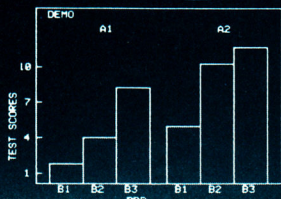
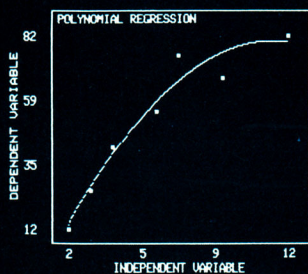

Statistics Made Simple
Run Analysis Immediately
With **The Statistics Series**

STATS PLUS \$200

Complete General Statistics Package
Research Data Base Management
Parametrics and Nonparametrics
Correlation, Regression

REGRESS II \$150

Complete Multiple Regression Package
Stepwise, Simultaneous Solutions
Power Polynomial Solutions

ANOVA II \$150

Complete Analysis of Variance Package
Analysis of Covariance, Randomized Designs

Apple II 48K, 1 or 2 Disk Drives,
DOS 3.3, ROM Applesoft



HUMAN SYSTEMS DYNAMICS

To Order—Call (800) 451-3030
(818) 993-8536 in CA
or Write

HUMAN SYSTEMS DYNAMICS
9010 Reseda Blvd., Suite 222
Northridge, CA 91324



COMING ATTRACTIONS

- Local Area Networks: How they work, choices in topology, and network products on the market now
- A special section on education:

A report on Apple II's in today's schools

Guidelines for buying educational software

Planning computer use in the schools: An excerpt from Joe Nathan's forthcoming book *Micro-Myths: Exploring the Limits of Learning with Computers*

An interview with Seymour Papert, creator of Logo

A Schoolbag of Programs: Three fun and useful programs for students

- Applesoft Adviser: A two-part column on Trivial Trivia. Dan Bishop gives you a trivia game for up to ten players—make up your own questions and answers in four categories

Maxell Floppy Disks

The Mini-Disks with maximum quality.

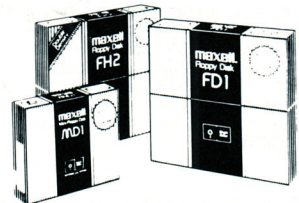

Dealer inquiries invited. C.O.D.'s accepted.
Call FREE (800) 235-4137.

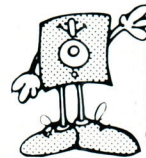

PACIFIC EXCHANGES
100 Foothill Blvd., San Luis
San Luis Obispo, CA 93401.
In Cal. call (800) 592-5935 or
(805) 543-1037.

Circle 31 on Reader Service Card.

This Publication is available in Microform.

**University Microfilms
International**

Please send additional information

for _____

Name _____

Institution _____

Street _____

City _____

State _____ Zip _____

300 North Zeeb Road, Dept. P.R., Ann Arbor, Mi. 48106

P-tral: BASIC to Pascal Translation Software

P-tral is the user-friendly translation software that converts Applesoft BASIC programs to Apple Pascal.

- Translates any business, scientific, graphics and game software from source.
- Translation results approach 100%.
- Translates any sized program—Large or Small.
- Essential compile directives generated.
- PIONEER version only \$125.00.

REQUIREMENTS: 64 / 128K RAM, Dos 3.3
80-column card / Apple II, IIe, IIc
Apple Pascal 1.1 or 1.2

To order or request more information
contact: **WOODCHUCK INDUSTRIES**
340 West 17th Street, New York, NY 10011
(212) 924-0576 / (212) 206-6490

Circle 174 on Reader Service Card.

What you should know about the International Apple Core.

If you're like most Apple users, you don't realize the many benefits of an IAC membership. Or what it can do for you and your computer.

So what's an IAC?

International Apple Core™ is a non-profit organization of Apple users and user groups. We are dedicated to providing education, information and support to users of Apple and Apple-compatible products.

We aren't just for clubs. An individual can enjoy all the special benefits we have been providing user groups since 1979. You may share information on new applications. Or learn the latest on products. Or keep up on Apple events. Even receive specialized training.

If you'd like to join a local user group or contact other Apple enthusiasts, we can help you find them.

A membership That pays you.

As a member of IAC you nearly get paid with what you will save. By joining you will save nearly \$20 on our electronic spreadsheet, *IACcalc*™. Not to mention all the other benefits only available to you as a member.

Information, please.

IAC provides many sources of information. Your \$30 yearly membership fee brings a 12-issue subscription to *Nibble* magazine devoted to Apple systems and compatibles. *Nibble* features more than \$50 worth of ready-to-run Apple programs in each issue. The programs focus on home, business, education and entertainment. *Nibble* also features new products, reviews, tips and techniques for learning more about your Apple and having fun doing it!

You will be eligible to receive the IAC *Disk of the Month*, a subscription to user contributed software. Each disk presents themes like games, education, or a potpourri.

Get an education.

You'll receive many educational benefits from our software programs. Our 3Pak™ series of theme packaged programs includes Educational, Financial, Games and the popular Logo. We have an Applesoft Tutorial and Education disk which is great for children.

Support for your Apple and you.

For as little as \$50 annually and no deductible, you can protect your hardware, software and disks for up to \$15,000.

Attach-Bios and *CP/M* → *SOS Converter* are ideal disks for Apple II Pascal and Apple III *CP/M*® application writers, vendors and users. All documentation is on the disks and no softcard is required to run Converter.

Invite your friends and save.

IAC offers user groups a special package. For \$90 your group receives a full year IAC membership and a subscription to *Nibble*. Included are the Disks of the Month and a listing of other IAC affiliated user groups world wide.

Individually or as a group you can't lose. So fill out the membership coupon below. And don't forget to ask for our product catalog.



The companies we keep.

Here is a list of the corporations that support and sponsor the International Apple Core.

Apple Computer Inc., Cupertino, CA
Brock Software Products, Crystal Lake, IL
Burtronix, Orange, CA
Digital Research, Pacific Grove, CA
East Side Software Co., New York, NY
Educational Software Products, Glencoe, IL
Electronic Arts, San Mateo, CA
General Microcomputer, Inc., Michigan City, IN
Hayes Microcomputer, Norcross, GA
Houston Instrument Division, Austin, TX
Howard D Sams Co. Inc., Indianapolis, IN
M&R Enterprises, Santa Clara, CA
Macworld, San Francisco, CA
Multi-Tech Systems, Inc., New Brighton, MN
Nestar Systems, Inc., Palo Alto, CA
Nibble/microSPARC, Inc., Lincoln, MA
Source Telecomputing, McLean, VA
Sundex Software Corporation, Boulder, CO
Turning Point Software, Watertown, MA
Vagabondo Enterprises, Aptos, CA
Verbatim Corporation, Sunnyvale, CA

Circle 157 on Reader Service Card.

Apple, Apple II, Apple III and SOS are registered trademarks of Apple Computer, Inc.

International Apple Core is Licensed by Apple Computer, Inc. to use certain of the latter's trademarks.

IACcalc and 3Pak are trademarks of International Apple Core. CPM is a registered trademark of Digital Research.

Nibble is a registered trademark of microSPARC, Inc.

Membership Application

- \$30 U.S. Individual
 \$40 Canada & Mexico Individual

- \$72 International Individual
 \$90 U.S. User Group Package
 \$152 International User Group Package

Name _____

Address _____

City _____

State/Zip _____ Country _____

All Memberships Include
a 12-Month Subscription to *Nibble*.

Please allow 6 to 8 weeks for the delivery of your first *Nibble*.

- Payment enclosed (U.S. funds only)
 VISA MasterCard
 Please send your product catalog.

Charge Card No. _____

Interbank No. _____ Expiration Date _____

MO DAY YEAR



**INTERNATIONAL
APPLE CORE™**

Membership Dept 1-04
467 Saratoga Ave. Ste. 228
San Jose, CA 95129
Membership orders: 408-988-4484
General information: 408-727-7652

Signature _____

EDITORS' CHOICE

Every month, hardware and software manufacturers release dozens of new products into the Apple II market. The Editors' Choice singles out one product each month that the *inCider* editors feel is a significant addition to the Apple II family of products.

With the introduction of the //c and the increasing popularity of the //e Extended 80-column card, 128K is quickly becoming the standard memory size for Apple II computers. Many software publishers have recognized this by releasing applications programs that run only on 128K Apples. Now joining the ranks of this software is a utility package—Extra K, from Beagle Bros—that lets you employ all 128K of memory from your Applesoft programs.

Extra K consists of 25 programs (some with associated machine-language files) that perform a myriad of tasks. For the serious programmer, the most important is Extra Variables, a program that stores the variables from your Applesoft programs in auxiliary memory. Normally, your Applesoft program plus variable storage cannot exceed 36K. With Extra Variables, your program alone can occupy 35K, and you'll still have 59K available for variable storage. If you write programs, such as data-base managers, that use a lot of string variables, you'll especially treasure Extra Variables—nothing gobbles up available memory faster than string variables. And Extra K also includes a utility called Peek and Poke, which lets you PEEK and POKE locations in auxiliary memory.

In what other ways can you use auxiliary memory? Extra K includes programs that use your extra 64K to speed up disk copying and disk comparisons. It also provides a routine, Disk Format, that lets you initialize a ProDOS disk from inside an Applesoft program. For those of you who are

graphics-inclined, other Extra K routines let you store numerous text and graphics screens in memory and display the screen of your choice in the wink of an eye. Also provided is a program called Screens Crop that lets you crop a hi-res image, resulting in some interesting effects (see the **Photo**).

If all that isn't enough for you, Extra K divides your Apple into two 64K machines—you can even load different operating systems into the two halves of your computer. In addition, you get a print spooler, which works only on the //c, and a program called Logbook, which creates a record in auxiliary memory of everything you enter into the text screen. The folks at Beagle Bros admit they don't know exactly how people will use Logbook, but they know a neat program when they see it.

As you can imagine, Extra K has really impressed *inCider's* editors. "Beagle Bros has done it again," Review Editor Paul Statt remarks. "Programming isn't fun unless you can play. Extra K is a sandbox for programmers—maybe you won't dig with every shovel or use every bit of memory in Extra K, but it's more fun to play when you have more toys. And reading Beagle Bros literature is always a panic." Editor in Chief Susan Gubernat says Extra K is a real bargain. "Where," she asks, "could you get 25 programs better than these for less than two dollars each?" Technical Editor Bob Ryan has one comment: "Wow!"

Oh yes—if you're one of those people who can't decide between DOS 3.3 and ProDOS, Beagle Bros isn't interested in dictating its preference: Extra K comes with DOS 3.3 format on the front of the disk, ProDOS on the back. Like all Beagle Bros soft-

ware, Extra K is not copy-protected.

Extra K is published by Beagle Bros, 3990 Old Town Avenue, Suite 102C, San Diego, CA 92110, (619) 296-6400. The package sells for \$39.95 and includes an updated copy of Beagle Bros' "Peeks, Pokes, and Pointers" chart. ■

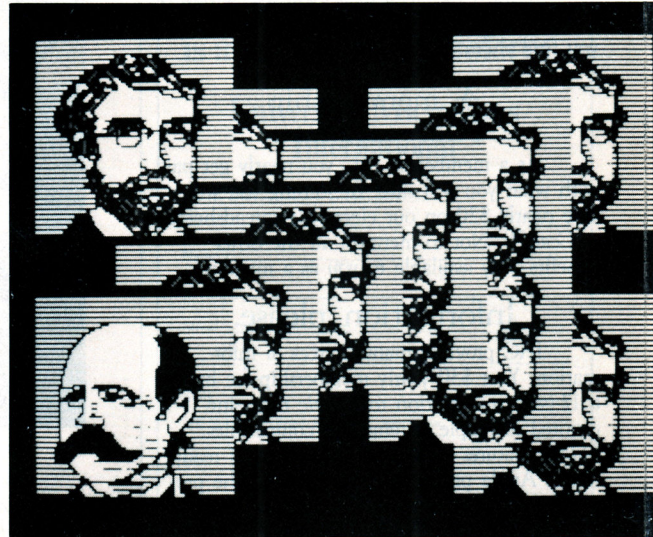
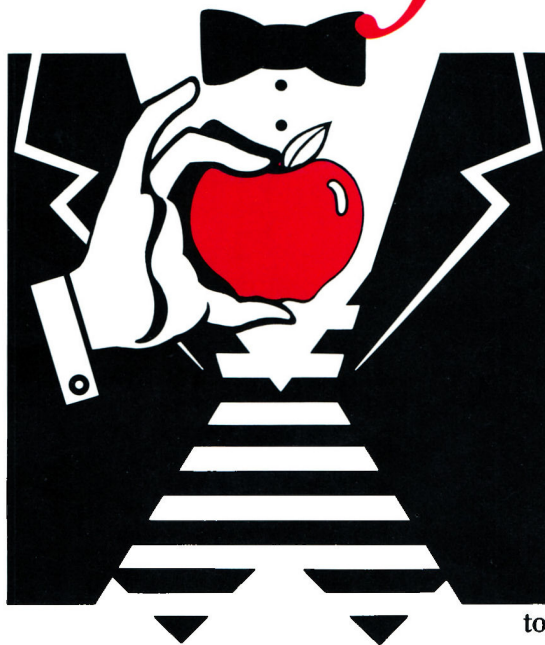

Photo.
Extra K's Screens Crop program crops high-resolution images and creates interesting effects.

While you and AppleWorks® are tackling the big jobs, who's handling the details? Introducing *Jeeves*™



THE AFFORDABLE PERSONAL ASSISTANT THAT LETS YOU AND APPLEWORKS WORK

HARDER. Sure, you and AppleWorks can tackle some pretty big problems. But what about life's little details? The phone calls. The appointments. The daily financial decisions. The mental notes.

Leave it to Jeeves, the first software program of its kind for the Apple//c and //e.

This new program from PBI works with AppleWorks to keep your life running as smoothly as your business.

Need to know what day your mother's birthday falls on? If you're free for lunch next Tuesday? What your insurance is costing per day? Or where you put the note you wrote to yourself this morning?

Leave it to Jeeves. For only \$49.95. (Not copy-protected.)

Jeeves not only provides you

AppleWorks is a registered trademark of Apple Computer, Inc. Jeeves is a trademark of PBI Software.

with instant access to five valuable desk organizers. It does it without interfering with your work.

APPOINTMENT CALENDAR. Use arrow keys to scroll month-by-month up to the year 2000.

PHONEDIALER WITH DIRECTORY. With modem, automatically dials phone numbers from directory, including long distance access codes.

FOUR-FUNCTION CALCULATOR. Two-line equation and result display shows chain calculations, lets you check entries and easily make corrections, deletions and substitutions.

MEMO PAD. A page for quick note taking.
SOFTWARE ALARM CLOCK. Time displayed on demand. Time and date stamp your files with or without a hardware clock.

One keystroke suspends your AppleWorks program and gives you immediate access to an appointment calendar, phonedialer with directory, four-function calculator, memo pad or software alarm clock.

Another keystroke and you're right back where you were.

So now when you sit down to work with AppleWorks, you can concentrate on your work. As for the rest, leave it to Jeeves. The affordable personal assistant.

To order, call 800-843-5722; in California, call 800-572-2746 9am-5pm PST or send in the coupon.

PBI Software
A SUBSIDIARY OF ITAT, INC.

1155B-H Chess Drive, Foster City, CA 94404
Please send _____ copies of Jeeves @ \$49.95 (plus \$3.00 shipping per order) to the address below.
___ Apple //c ___ Enhanced Apple //e (Requires Mousecard™ AST Multi I/O™ or Thunderclock™)

CA residents add \$3.25 sales tax for each copy ordered

Total amount enclosed \$ _____

Payment VISA MC Check No COD's
Card Number _____

Expiration date _____ / _____

Name _____

Address _____

City _____ State _____ Zip _____

Telephone (____) _____

I-8/5

Introducing the Most Powerful Business Software Ever!

TRS-80™ (Model I, II, III, or 16) • APPLE™ • IBM™ • OSBORNE™ • CP/M™ • XEROX™



The VERSABUSINESS™ Series

Each VERSABUSINESS module can be purchased and used independently, or can be linked in any combination to form a complete, coordinated business system.

VERSA RECEIVABLES™ \$99.95
 VERSA RECEIVABLES™ is a complete menu-driven accounts receivable, invoicing, and monthly statement-generating system. It keeps track of all information related to who owes you or your company money, and can provide automatic billing for past due accounts. VERSA RECEIVABLES™ prints all necessary statements, invoices, and summary reports and can be linked with VERSA LEDGER II™ and VERSA INVENTORY™.

VERSA PAYABLES™ \$99.95
 VERSA PAYABLES™ is designed to keep track of current and aged payables, keeping you in touch with all information regarding how much money your company owes, and to whom. VERSA PAYABLES™ maintains a complete record on each vendor, prints checks, check registers, vouchers, transaction reports, aged payables reports, vendor reports, and more. With VERSA PAYABLES™, you can even let your computer automatically select which vouchers are to be paid.

VERSA PAYROLL™ \$99.95
 VERSA PAYROLL™ is a powerful and sophisticated, but easy to use payroll system that keeps track of all government-required payroll information. Complete employee records are maintained, and all necessary payroll calculations are performed automatically, with totals displayed on screen for operator approval. A payroll can be run totally, automatically, or the operator can intervene to prevent a check from being printed, or to alter information on it. If desired, totals may be posted to the VERSA LEDGER II™ system.

VERSA INVENTORY™ \$99.95
 VERSA INVENTORY™ is a complete inventory control system that gives you instant access to data on any item. VERSA INVENTORY™ keeps track of all information related to what items are in stock, out of stock, on backorder, etc., stores sales and pricing data, alerts you when an item falls below a preset reorder point, and allows you to enter and print invoices directly or to link with the VERSA RECEIVABLES™ system. VERSA INVENTORY™ prints all needed inventory listings, reports of items below reorder point, inventory value reports, period and year-to-date sales reports, price lists, inventory checklists, etc.

VERSA LEDGER II™ \$149.95
 VERSA LEDGER II™ is a complete accounting system that grows as your business grows. VERSA LEDGER II™ can be used as a simple personal checkbook register, expanded to a small business bookkeeping system or developed into a large corporate general ledger system **without any additional software.**

- VERSA LEDGER II™ gives you almost unlimited storage capacity (300 to 10,000 entries per month, depending on the system),
- stores all check and general ledger information forever,
- prints tractor-feed checks,
- handles multiple checkbooks and general ledgers,
- prints 17 customized accounting reports including check registers, balance sheets, income statements, transaction reports, account listings, etc.

VERSA LEDGER II™ comes with a professionally-written 160 page manual designed for first-time users. The VERSA LEDGER II™ manual will help you become quickly familiar with VERSA LEDGER II™, using complete sample data files supplied on diskette and more than 50 pages of sample printouts.

SATISFACTION GUARANTEED!

Every VERSABUSINESS™ module is guaranteed to outperform all other competitive systems, and at a fraction of their cost. If you are not satisfied with any VERSABUSINESS™ module, you may return it within 30 days for a refund. Manuals for any VERSABUSINESS™ module may be purchased for \$25 each, credited toward a later purchase of that module.

To Order: Write or call Toll-free (800) 431-2818 (N.Y.S. residents call 914-425-1535)

- * add \$3 for shipping in UPS areas
- * add \$5 to CANADA or MEXICO
- * add \$4 for C.O.D. or non-UPS areas
- * add proper postage elsewhere

DEALER INQUIRIES WELCOME
 All prices and specifications subject to change / Delivery subject to availability.

COMPUTRONICS

50 N. PASCACK ROAD, SPRING VALLEY, N.Y. 10977

* TRS-80 is a trademark of the Radio Shack Division of Tandy Corp. • APPLE is a trademark of Apple Corp. • IBM is a trademark of IBM Corp. • OSBORNE is a trademark of Osborne Corp. • CP/M is a trademark of Digital Research • XEROX is a trademark of Xerox Corp.